



Department of
Veterans Affairs

Office of Construction & Facilities Management

designguide

FEBRUARY 2011

OFFICE OF INFORMATION & TECHNOLOGY



This page intentionally left blank.



TABLE OF CONTENTS

Section 1	Foreword & Acknowledgments Foreword Introduction Definitions Abbreviations Legend of Symbols
Section 2	Narrative General Considerations Concept of Operations Functional Considerations Technical Considerations
Section 3	Functional Diagrams General Considerations Functional Diagram OIT Functional Area Diagrams Functional Relationships Matrix
Section 4	Design Guide Plates, Design Standards, and Equipment Lists Introduction Guide Plates
Section 5	Appendix Index/Cross Reference to Guide Plates Sorted by SEPS Code

This page intentionally left blank.

Section 1

Foreword & Acknowledgments

Foreword.....1-1
Acknowledgments.....1-3
Introduction1-5
Definitions1-6
Abbreviations1-10
Legend of Symbols1-11

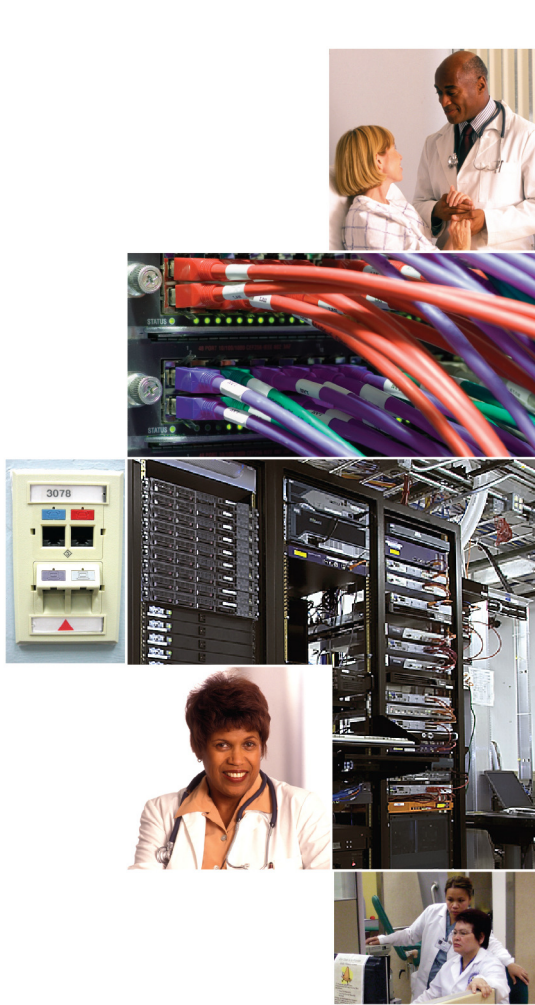

This page intentionally left blank.

Foreword

The material contained in the Office of Information & Technology (OIT) Design Guide is the culmination of a partnering effort within the Department of Veterans Affairs by the Office of Information & Technology and the Office of Construction & Facilities Management, Strategic Management Office. The goal of this Design Guide is to facilitate the design process and to ensure the quality of VA facilities while controlling construction and operating costs.

This document is intended to be used as a guide and to supplement current technical manuals and other VA criteria in planning OIT space. The Design Guide is not to be used as a standard design. Use of this Design Guide does not preclude the need for a functional and physical design program for each specific project. It is the responsibility of the Project Architect and the Project Engineer to develop a complete and accurate project design that best meets the users' needs and applicable code requirements.

Lloyd H. Siegel, FAIA
Director
Strategic Management Office

This page intentionally left blank.

Acknowledgments

Credit is due to the following individuals whose guidance, advice, and effort made this publication possible:

Office of Construction & Facilities Management (00CFM)

Robert L. Neary, Jr.	Acting Director, Office of Construction & Facilities Management
Lloyd H. Siegel, FAIA	Director, Strategic Management Office
Kurt D. Knight, PE	Chief, Facilities Quality Service
Lam Vu, PE	Senior Electrical Engineer
Zoltan Nagy, AIA	Senior Architect
Gary Fischer, RA	Senior Architect
Dennis Sheils	Management and Program Analyst
Mollie West, MHA	Health System Specialist

Office of the Deputy Under Secretary for Health for Operations and Management (10N)

David Klein, PE	Senior Fire Protection Engineer
Peter Larrimer, PE	Senior Fire Protection Engineer

Office of Information & Technology

Forrest F. Frakes, CET, PC	Acting Chief, Special Systems Team
Keith Van Bakel	Special Systems Team

Private Sector Consultants

Theodore C. Moeller, PE	GLHN Architects & Engineers, Inc.
Nicholas C. Krauja, AIA	GLHN Architects & Engineers, Inc.
Victoria Benavidez, RCDD	GLHN Architects & Engineers, Inc.
Ronald Villasante, RA	HDR, Inc.
April Dermeitis, RN, MSN	HDR, Inc.

This page intentionally left blank.

Introduction

The Office of Information & Technology (OIT) Design Guide was developed as a design tool to assist medical center staff and contracting officers in better understanding the choices that designers ask them to make, and to help designers understand the functional requirements necessary for proper sizing of OIT areas and spaces in Veterans Affairs (VA) medical centers, outpatient clinics, community-based outpatient clinics, and other medical facilities.

This Design Guide is not intended to be project-specific. It addresses the general functional and technical requirements of the spaces required to support OIT. While this Guide incorporates strategies to address adaptability, it is not possible to foresee all future requirements. The project-specific Program for Design (PFD) is the basis for an individual project design. It is important to note that the Guide Plates in Section 4 are generic graphic representations illustrating VA's furniture, equipment, and personnel space needs. They are not meant to limit design opportunities.

The OIT Design Guide includes graphic consolidation of data from existing VA standards and criteria. See PG-18-3 Design and Construction Procedures, Topic 1 (<http://www.cfm.va.gov/TIL/cPro.asp>) for the latest editions of the codes and standards adopted by VA as a minimum for all projects performed in the modernization, alteration, addition, or improvement of its real property and the construction of new structures. VA Design Manuals and Master Specifications specify other codes and standards that VA follows on its projects. VA OIT follows industry standards, including but not limited to, American National Standards Institute (ANSI), Electronic Industries Alliance (EIA)/ Telecommunications Industry Association (TIA), and Building Industry Consulting Service International (BICSI) Telecommunications Distribution Methods Manual (TDMM).

The project A/E shall read and be familiar with the most current editions of the applicable codes, standards, and guides and manuals. This Design Guide refers to the above mentioned sources when data is either too detailed or too broad to be included in this guide. These sources can be accessed at the Office of Construction and Facilities Management's Technical Information Library (TIL) (<http://www.cfm.va.gov/TIL>).

Use of this Design Guide does not supersede the project A/E's responsibilities to develop a complete and accurate design that meets the user's needs and the appropriate code requirements within the budget constraints. Equipment manufacturers should be consulted for actual dimensions and utility requirements.

Definitions

A. Access Floor: A flooring system consisting of removable, modular panels supported on pedestals or stringers. The under-floor plenum space is used for distribution of power circuits and conditioned air.

B. Active Equipment: Energized equipment used for receiving or transmitting analog or digital signals, such as servers, hubs, routers, switches, rack-mounted UPSs, servers, firewalls, etc.

C. Active (Data) Storage: Secure area for temporary storage of removable media containing active data.

D. Archive (Data) Storage: A secure, offsite or remote area for storage of inactive or backup data, media, and electronic records.

E. Automated Information Storage System (AISS): An enclosed storage and retrieval system that moves recorded media between storage and IT equipment.

F. Backup Computer Room: Room that houses redundant, mission-critical IT equipment. The room is located remotely from the *Main Computer Room*.

G. Cabinet: A protected enclosure containing a standardized frame for mounting multiple active IT or electronic equipment modules. Cabinets are designed to accommodate equipment modules of standard widths and heights. Standard widths are nominal 19-inch (the most common) or 23-inch. The heights of standard modules are multiples of 1.75-inches (this dimension is known as one "Rack Unit" or "U"). A cabinet houses *Active Equipment*. For unenclosed frames, see *Rack*.

H. Computer Area: An area of a building containing the *Main Computer Room* and associated spaces served by a dedicated HVAC system.

I. Computer Equipment: See *Information Technology Equipment*.

J. Computer Floor: See *Access Floor*.

K. Computer Room: A room or space containing *Information Technology Equipment*. See also *Main Computer Room*.

L. Concept of Operations: A user-developed guide to the functional operation of the VA facility. It defines the function of the facility and the scope of services to be provided in the new or remodeled space(s).

M. Demarc Room: Also known as the Demarcation Room, and formerly known as the Main Distribution Frame (MDF). It is the space where services brought to the facility by outside providers, such as telephone, data, and cable television providers, are initially terminated. The service provider network cabling ends and the VA premises cabling begins in this room.

N. Departmental Net to Gross (DNTG) Conversion Factor: A parameter, determined by the VA for each Space Planning Criteria chapter, used to convert the programmed Net Square Foot (NSF) area to the Department Gross Square Foot (DGSF) area. The DNTG Departmental Conversion Factor for OIT is 1.25.



O. Desktop Computer: IT equipment designed for individual use at a workstation, and used to input, retrieve, and manipulate information. A desktop computer typically consists of a processor unit, monitor, keyboard, mouse, and speakers.

P. Digital Telephone (PBX) Equipment: Digital Telephone Equipment switches digital voice signals. This system is powered from the Life Safety branch of the Emergency Power System (NFPA 70, Article 517) and may be used to issue instructions during emergency conditions.

Q. Facilities Management Service (FMS) Communications Systems and Equipment: Microprocessor based systems and/or equipment that are **outside the purview of OIT**, such as, but not limited to: Nurse Call and/or Code Blue (Blue); PACS; Television (Master Antenna [MATV], Community Antenna [CATV], Closed Circuit [CCTV] [for education] & Satellite TV [SATV]); Radio (Paging [Code Blue, Emergency & Routine]), Microwave, Satellite Radio/Telephone & Radio Entertainment; Public Address (Overhead Paging, Mass Notification, and Intercommunications [Intercom]); Physical Security Management (Access Control, Motion Intrusion Detection, Duress and/or Panic Alarm & Security Surveillance Television [SSTV]); Patient, Staff and Asset Monitoring (Medical Telemetry, Patient/Staff Location, and Cardiac); Energy Management; Emergency (Fire Alarm/Mass Notification, Police, and Disaster). These systems and equipment shall be located in the FMS area of the *Telecommunications Rooms* and the *Antenna Equipment Headend Room*. Headend, host servers, or active equipment associated with archiving, packetized storage, or transport of confidential information generated by a FMS system shall be located within the *OIT Equipment Area of the Main Computer Room*, and will be serviced and managed by OIT.

R. Full-Time Equivalent (FTE): A staffing parameter equal to the amount of time assigned to one full time employee. It may be composed of several part-time employees whose total time commitment equals that of a full-time employee. One FTE equals 40 hours per week.

S. Input Data Statements: A set of questions that elicit information used to create a Program for Design (PFD) based on the criteria parameters set forth in this document. Input Data Statements are Mission-related, based on the project's Concept of Operations; and Workload and Staffing related, based on projections and data provided by the Veterans Health Administration (VHA) or the Veterans Integrated Service Network (VISN) about the estimated model of operation for the facility. This information is processed through mathematical and logical operations in *VA-SEPS*.

T. Information Technology (IT): The design, development, implementation, support and management of computer-based information systems, particularly software applications and computer hardware.

U. Information Technology (IT) Equipment: Any electronic digital computer, with all peripheral, support, memory, programming, or other directly associated equipment, records, and activities.

V. Information Technology Equipment Area: Used in 2003 and later editions of NFPA 75 in lieu of the term "computer equipment area." See *Computer Area*.



- W. Information Technology Equipment Room: Used in 2003 and later editions of NFPA 75 in lieu of the term “computer room.” See *Computer Room*.
- X. Jack: Female telecommunications connector used to connect field equipment to horizontal cabling. See also *Port*.
- Y. Main Computer Room: A room containing both primary information technology systems active equipment and passive backbone cabling distribution terminations. The Main Computer Room is one of the spaces located within the Computer Area functional area. The OIT IT and FMS IT systems housed in the Main Computer Room may include, but are not limited to: Voice over IP (VoIP), Voice (PBX), Data LAN, Wireless LAN, PACS, Digital Imaging, Asset Tracking/Management, Patient Monitoring Systems, Video Surveillance, Security Access, Nurse Call, MATV/CATV, Public Address, Fire Alarm, Mass Notification, and Overhead Paging.
- Z. NFPA 75: National Fire Protection Association, Standard for the Protection of Information Technology Equipment.
- AA. Information Technology Equipment (OIT): Any electronic digital or analog computer, with peripheral support, memory, programming, or other directly associated equipment, records, and activities that supports VA’s Healthcare Mission and allows archiving and/or packetized storage and transportation of confidential patient, staff or public information. OIT equipment located with OIT Equipment Area of the *Main Computer Room* **is not permitted to actively process life safety data, nor any FMS systems Data** (refer to *Facilities Management Service (FMS) Communications Systems and Equipment*).
- BB. OIT: VA Office of Information & Technology.
- CC. Passive Distribution Equipment: Equipment that does not require electrical power and does not modify the transmitted signal through amplification, retiming or regeneration. Passive distribution equipment is used for the termination of backbone fiber optic cabling. For termination of passive voice copper, see *Voice Passive Distribution Area*.
- DD. Personal Computer (PC): See *Desktop Computer*.
- EE. Port: An identifier of an application process within the TCP/IP suite. An active port may be for voice, VoIP, or data service, and is the assignment connectivity between a server and a network-connected device (such as workstation, printer, or wireless access point). While a port cannot be physically associated with a jack, it requires physical space for the active server equipment associated with it. See also *Jack*.
- FF. Professional Staff: Professional Staff includes Chief, Assistant Chief, Section Heads, Supervisors, and Programmers.
- GG. Program for Design (PFD): A space program based on criteria set forth in Space Planning Criteria Chapter 232, and specific information about Concept of Operations, workload projections, and authorized staffing levels.
- HH. Rack: An open (non-enclosed) standardized frame for mounting multiple passive IT or electronic equipment modules. Racks are designed to accommodate equipment modules of standard widths and heights. Standard widths are nominal 19-inch (the most













common) or 23-inch. The heights of standard modules are multiples of 1.75-inches (this dimension is known as one "Rack Unit" or "RU"). A rack houses passive (non-powered) equipment, such as patch panels and Fiber Distribution Units (FDU). For enclosed frames, see *Cabinet*.





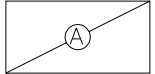







- II. Raised Floor: See *Access Floor*.
- JJ. SEPS (VA-SEPS): Acronym for Space and Equipment Planning System, a digital tool developed by the Department of Defense. VA-SEPS, the Department of Veterans Affairs version of SEPS, is used to generate a Program for Design and an Equipment List for a VA project, based on specific information entered in response to Input Data Questions. VA-SEPS incorporates the propositions set forth in the VA Space Planning Criteria chapters. VA-SEPS has been designed to aid planners in creating a program for design based on a standardized set of criteria parameters.
- KK. Service Provider: Outside providers of services to the facility, such as telephone, data, and cable television providers.
- LL. Telecommunications Infrastructure Plant (TIP): The TIP comprises the facility's outside and inside cable plant.
- MM. Telecommunications Room (TR): A room used for both OIT active and passive IT distribution equipment and FMS active and passive distribution equipment. The term "Telecommunications Room" replaces the legacy terms "Signal Closet" and "Telecommunications Closet," which are no longer used.
- NN. Telecommunications Support Area: Within the space program for OIT, the Telecommunications Support Area is the functional area that contains spaces primarily used for the OIT and FMS backbone distribution systems, including the Demarc Rooms and the Telecommunications Rooms.
- OO. Uninterruptible Power Supply (UPS): A system of electrical power conditioning and battery storage used to provide continuous power to IT equipment.
- PP. Voice over Internet Protocol (VoIP) System and Equipment: Digital voice equipment in which analog voice signals are converted to digital packets and transmitted over a Local Area Network (LAN) using Transmission Control / Internet Protocol. This system may be powered from the Essential Branch of the Emergency AC Power System (Reference NFPA 70, Articles 517 & 800).
- QQ. Voice Passive Distribution Area: Area for wall-mounted terminations of copper voice backbone cables.

Abbreviations

A	Amperes	MCS	Master Construction Specifications
ABA	Architectural Barriers Act	MID	Motion Intrusion Detection
ADA	Americans with Disabilities Act	MTD	Mounted
AFF	Above Finished Floor	NFPA	National Fire Protection Association
AR	As Required	NSF	Net Square Feet
AT	Acoustical Ceiling Tile	NSM	Net Square Meters
AT (SP)	Acoustical Ceiling Tile (with Sprayed Plastic Finish)	OCFM	Office of Construction & Facilities Management
BC	Base Cabinet	OIT	Office of Information & Technology
C	Degree Celsius	OPC	Outpatient Clinic
CB	Circuit Breaker	PACS	Picture Archiving and Communication System
CBOC	Community Based Outpatient Clinic	PH	Phase
CC	Contractor Furnished, Contractor Installed	PL	Plaster
CFM	Cubic Feet per Minute	PFD	Program for Design
CLG	Ceiling	PSDM	Physical Security Design Manual
CP	Carpet (without cushion broadloom)	RB	Resilient Base
CPT	Carpet Tile	RPS	Radio Paging System
CRS	Corrosion Resisting Steel (SS)	RSF	Resilient Sheet Flooring
CT	Ceramic Tile	SD	Standard Detail
DG	Design Guide	SF	Square Feet, Square Foot
DS	Door Switch	SOPC	Satellite Outpatient Clinic
EDM	Electrical Design Manual	SSTV	Security Surveillance Television
ESS	Essential Electrical System	STC	Sound Transmission Class
F	Degrees Fahrenheit	TBB	Telecommunications Bonding Backbone
FC	Foot-candle	TGB	Telecommunications Ground Bar
FD	Floor Drain	UPS	Uninterruptible Power Supply
FIXT	Fixture	V	Volts
FLUOR	Fluorescent	VA	Department of Veterans Affairs
FMS	Facilities Management Service	VACO	Veterans Affairs Central Office
GFI	Ground Fault Circuit Interrupter	VAMC	Veterans Affairs Medical Center
GWB	Gypsum Wallboard	VC	VA Furnished, Contractor Installed
HAC	Housekeeping Aids Closet	VCT	Vinyl Composition Tile
HVAC	Heating, Ventilating and Air Conditioning	VHA	Veterans Health Administration
HP	Horsepower	VTEL	Video Teleconferencing
HR	Hour	VV	VA Furnished, VA Installed
kW	Kilowatt	W	Watts
LB	Pound/Pounds	WSF	Welded Seamless Flooring
LLTS	Lockers, Lounges, Toilets & Showers	W/SF	Watts per Square Foot
MATV	Master Antenna Television		

Legend of Symbols

SYSTEM	DESCRIPTION OF SYMBOLS	SYMBOL
Wiring Devices and Power	Duplex receptacle, NEMA 5-20R 20 amp, mounted 18" AFF unless otherwise noted	
	Quadruplex receptacle, NEMA 5-20R 20 amp, mounted 18" AFF unless otherwise noted	
	Duplex receptacle in ceiling, NEMA 5-20R 20 amp	
	Duplex receptacle on emergency power, NEMA 5-20R 20 amp, mounted 18" AFF unless otherwise noted	
	Quadruplex receptacle on emergency power, NEMA 5-20R 20 amp, mounted 18" AFF unless otherwise noted	
	Junction box in ceiling, purpose and location as noted	
	Junction box in wall, purpose and location as noted, mounted 18" AFF unless otherwise noted	
	Telecommunications equipment potential ground bar, surface mounted at 18" AFF unless otherwise noted.	
Lighting Controls	Single pole switch, mounted 46" AFF	S
	Occupancy sensor switch, mounted 46" AFF	S ^M
	Three - way switch, mounted 46" AFF	S ³
Lighting Fixtures	2'x4' fluorescent fixture	
	2'x4' fluorescent fixture, on emergency power	
	Suspended strip fluorescent fixture with wire guard	
	Suspended strip fluorescent fixture with wire guard, on emergency power	

SYSTEM	DESCRIPTION OF SYMBOLS	SYMBOL
Telecommunications Systems	Voice and data outlet, mounted 18" AFF unless otherwise noted	
	Telephone outlet, mounted 46" AFF unless otherwise noted	
	Video outlet, mounted 18" AFF unless otherwise noted	
	Video outlet in ceiling	
	Security / duress alarm button, mounted 3" above counter top or counter top back splash	
	Security / duress alarm button, mounted 46" AFF unless otherwise noted	
	Card reader, mounted 46" AFF unless otherwise noted	
	Motion intrusion detector, ceiling-mounted	
	Motion intrusion detector, wall-mounted	
	Security surveillance television camera	
HVAC	Supply air grille	
	Return air grille	
Fire Suppression	Sprinkler head	



Section 2

Narrative

	Page
General Considerations	2-1
Office of Information & Technology	2-1
VA Trends	2-1
Concept of Operations	2-1
Responsibilities	2-1
Functional Considerations.....	2-3
Space Planning	2-3
Functional Areas	2-4
Functional Relationships	2-7
General Planning Concepts.....	2-7
Technical Considerations	2-9
Accessibility (ABA)	2-9
Physical Security and	
Natural Disasters.....	2-9
Architectural	2-10
Fire Protection.....	2-12
EMI/RFI and Environmental Factors...2-13	
Energy Conservation and Sustainable	
Design.....	2-13
Heating, Ventilation, and	
Air Conditioning.....	2-13
Plumbing	2-15
Electrical	2-15
Waste Management	2-15
Circulation Systems.....	2-16
Data Service Reliability.....	2-16
Voice Systems Minimum Operational	
Requirements.....	2-16
Main Computer Room	2-18
Telecommunications Rooms	2-20
Remote Telecommunications Rooms.2-23	
Existing Facilities.....	2-23

This page intentionally left blank.

General Considerations

Office of Information & Technology

The Office of Information & Technology (OIT) is responsible for providing strategic and technical direction, guidance, and policies to ensure that information technology (IT) resources are optimally acquired and managed for VA, and responsible for ensuring the efficient and effective operation of VA's IT Management System.

This document also provides space planning guidance for the IT requirements of Facilities Management Service (FMS). Some of the functional areas and rooms are jointly used by both OIT and FMS.

VA Trends

Physical Security: Physical security is a prominent concern with VA, for both new construction and existing facilities. Refer to the VA Physical Security Design Manual (<http://www.cfm.va.gov/til/spclRqmts.asp>) for applicable requirements for OIT and FMS telecommunications spaces, systems, and equipment.

Co-located OIT and FMS Systems: Many FMS building systems are now electronically monitored and managed, and require non-OIT IT equipment and servers. In the past, these systems were typically located in building mechanical and electrical rooms. Now, environmental, physical, and at times communications security requirements for server-based FMS systems mandate that this equipment be co-located with OIT equipment in the Main Computer Room, Telecommunications Rooms, and Antenna Headend Equipment Room, when specifically approved and authorized.

Concept of Operations

Responsibilities

The Office of Information & Technology is responsible for the management and operation of the IT program to support patients, staff, and services at each VA medical facility. This IT program support includes all aspects of designing, implementing, operating, and maintaining the computer-based IT systems within their purview. These services provided by OIT to support each facility include: management consulting; user support and training; technical management; around-the-clock operations; and maintenance of hardware, software, and telecommunications systems. The scope and organization of OIT responsibilities may vary among medical centers. OIT may assume oversight for those systems outside OIT's purview (such as FMS systems) once specific system(s) have been specifically addressed and approved.

This page intentionally left blank.

Functional Considerations

Space Planning

Program for Design: Net square footages shown in this Design Guide are coordinated with VA's Space Planning Criteria (<http://www.cfm.va.gov/TIL/planning.asp>), Chapter 232 - Office of Information & Technology. Unless noted, the guide plates illustrate the basic net area for each space or functional area. The Program for Design (PFD) for a specific project will vary according to facility NSF, OIT IT systems and equipment, FMS systems and equipment, and the size and scope of the medical mission. The design A/E is responsible for accommodating the project-specific program for design and functional requirements.

Space planning criteria have been developed on the basis of an understanding of the activities involved in the OIT functional areas, and their relationship with other services of a medical facility. These criteria are predicated on established and/or anticipated best practice standards.

Quantities and sizes of spaces required in the Reception Area, Staff and Administrative Area, and Staff Lounge, Lockers and Toilets functional areas are determined primarily from the projected FTEs assigned to OIT.

Quantities and sizes of spaces required for functions in the Computer Area, the Computer Support Area, and the Telecommunications Support Area are determined primarily from the total net area of the building. The minimum space requirements have been established with consideration for the types and amounts of information technology equipment and infrastructure to be provided or maintained by OIT and FMS.

VA OIT determines types and quantities of IT equipment from VHA-anticipated facility needs and other official instructions. The Main Computer Room and Telecommunications Rooms are sized on the quantity of floor-mounted cabinets, racks, and trunk and backbone lines in and out required to support the number of anticipated subscriber ports and lines. The number of anticipated ports and lines has been related to the total net area of the building based on OIT field experience. The quantity of cabinets and racks allocated will support the IT equipment needed for the anticipated number of lines and ports, plus both 50 percent expected expansion and space for anticipated systems redundancy.

Within the Main Computer Room, space requirements are computed separately for OIT IT active equipment, OIT IT passive distribution equipment, voice (telephone) active and passive equipment, FMS active equipment, and FMS passive distribution equipment. The separate space requirements are then totaled to establish the size of the Main Computer Room. The size of the adjacent HVAC and Electrical Equipment Room is established in proportion to the Main Computer Room.

The number of Telecommunications Rooms is based on the total net area of the building. Telecommunications Rooms must be located within the allowable cabling distance from all areas served. TRs are included in the net area for OIT in the Program for Design. The area required for any additional TRs necessary beyond the quantity established by the Program for Design shall be taken from the overall building grossing factor.

These criteria are subject to modification relative to development in equipment, and subsequent planning and design.

Functional Areas

A Functional Area is the grouping of rooms and spaces based on their function within a service. The organization of services in this Guide follows the categories established in VA's Space Planning Criteria (<http://www.cfm.va.gov/TIL/planning.asp>), Chapter 232 - Office of Information & Technology. There are six Functional Areas, identified as follows:

- FA1, Reception Area
- FA2, Computer Area
- FA3, Computer Support Area
- FA4, Telecommunications Support Area
- FA5, Staff and Administrative Area
- FA6, Staff Lounge, Lockers and Toilets

The functional areas that are most critical to OIT's mission include the Computer Area (which contains the Main Computer Room), the Computer Support Area, and the Telecommunications Support Area (which includes the Telecommunications Rooms).

Space may also be required to support redundant or backup VA OIT equipment for other medical centers or facilities, the VISN, the region, or the nation. If required, this equipment may be located in the Main Computer Room, or in a remote Backup Computer Room. Determination will be made by OIT on a case-by-case basis.

The remaining functional areas are the Reception Area, Staff and Administrative Area, and Staff Lounge, Lockers, and Toilets. These areas provide space for staff and administrative offices, training classrooms, and office support functions.

Not all functional areas are required for all facility sizes. Refer to VA's Space Planning Criteria (<http://www.cfm.va.gov/TIL/planning.asp>), Chapter 232 – Office of Information & Technology.

FA1, Reception Area: The Reception area is located at the entry to OIT to accommodate visitors and vendors. It includes seating for waiting (when provided) and a public toilet. This area includes workspace for an administrative assistant or assistants as necessary. The Reception Area has a strong need for adjacency with the Staff and Administrative Area.

FA2, Computer Area: The Computer Area includes spaces for active and passive OIT IT and FMS IT equipment and regularly used support equipment. Space for storage of active media is included in the Computer Area. The Computer Area has a strong need for adjacency with the Computer Support Area.

The following spaces are to be located in the Computer Area, and will have dedicated HVAC systems when separation from spaces in Computer Support Area is to be provided in accordance with NFPA 75. For small facilities with limited risk as determined by VA OIT and OCFM (see Section 4 of NFPA 75), spaces for the Computer Area and Computer Support Area may be combined.

- **Main Computer Room:** The Main Computer Room contains areas for both OIT and FMS active and passive IT equipment, and any support equipment which must be immediately adjacent. These areas are summed to form the Main Computer Room. Space is allocated for:



- OIT IT active equipment
 - OIT IT passive distribution equipment
 - FMS active equipment
 - FMS passive distribution equipment
 - Voice active equipment and passive distribution equipment (for either VoIP or digital telephone PBX)
- Network Operations Room: This room provides workspace for two computer operators/technicians immediately adjacent to the Main Computer Room.
 - Storage, Active Data: This space is used for storage of active media or records and is immediately accessible from the Main Computer Room.
 - HVAC and Electrical Equipment, Computer Area: This space houses mechanical and electrical equipment that supports the Main Computer Room and that cannot or should not be located within the Main Computer Room. Computer Room Air Conditioning units (CRACs) and clean agent fire suppression tanks are to be located in this space, as are power panelboards that serve Main Computer Room UPS equipment, and power panelboards that distribute UPS power back to Main Computer Room equipment.
 - Backup Computer Room: This room provides space for redundant, mission-critical, IT equipment when required by OIT to ensure continuity of service. When authorized, this space shall be provided at a location remote from the Main Computer Room.

FA3, Computer Support Area: Accommodates support services for the functions within the Computer Area. These spaces will not be served from the Computer Area air conditioning system. This functional area may include:

- Storage, Temporary Data: This space provides for short-term storage of media or records remote from the Computer Area.

Provide the following spaces when on-site equipment configuration and repair of information technology equipment and PCs is authorized:

- Workroom, Equipment Configuration / Repair: This space provides for two service technician workstations and space for storage of small parts and equipment used in configuration and repair of information technology equipment.
- Storage, IT Equipment: This space provides for secure bulk storage of new or surplus IT equipment and other large items.
- Receiving / Breakdown Room: This space is used to unpack new equipment before moving to storage, to hold packing materials for disposal, and to stage equipment to be transported or removed.

FA4, Telecommunications Support Area: Accommodates equipment and support functions for distribution of OIT and FMS services throughout the facility. This functional area may include:

- Demarc Room: This room provides space for the initial termination of services brought to the facility by outside providers, such as telephone providers, data providers, MATV/CATV providers, security providers, etc. Two Demarc Rooms are required for mission critical facilities (see the VA Physical Security Design Manual).
- Antenna Headend Equipment Room: This room contains all provided and planned head-end cabinets for antenna-based FMS systems (i.e., MATV/CATV, Two-Way

Radio, RPS, etc.). The room shall be sized for a minimum of five each separate systems, and four each future systems. Refer to the VA Electrical Design Manual.

- Telephone Operators Room: This area houses the telephone operators for the facility. This location is often, but not always, continuously staffed. Operators may also have responsibility of monitoring critical alarms for equipment or systems at the facility. Do not duplicate space when this function is the responsibility of Medical Administration / Health Administration Service (HAS).
- Toilet, Staff: Locate immediately adjacent to Telephone Operators Room.
- Lounge, Telephone Operators: Locate immediately adjacent to Telephone Operators Room.
- Telecommunications Room (TR): These rooms contain OIT-supported active and passive equipment, FMS-supported active and passive equipment, and all internal vertical and horizontal TIP conduits and wire management systems. There may be multiple TRs on each floor, and TRs may be associated with a specific functional area(s). The designation TR replaces the terms "Signal Closet," "Telecommunications Closet," and "IDF," which are no longer used.

FA5, Staff and Administrative Area: Accommodates staff workstations (in offices or cubicles), staff conference and workrooms, computer training classroom, spaces for office equipment, and storage of forms, supplies, training materials, and housekeeping aides. This functional area may include:

- Office, Chief of Service
- Office, Assistant Chief of Service
- Office, Section Head / Supervisor
- Cubicle, Programmer: In open office space with systems furniture.
- Cubicle, Computer Operator / Technician: In open office space with systems furniture.
- Cubicle, Customer Service / Help Desk: In open office space with systems furniture.
- Conference Room
- Copy Room: This space is for office equipment, including copier, fax, and staff mailboxes.
- Storage, Forms / Literature: This space provides storage of forms and general office supplies for the Administrative Area.
- Classroom, Computer Training: This space provides workstations for computer-based training.
- Storage, Computer Training: This space is used for storage of training materials.
- Workroom, Projects: This space provides a multipurpose staff workroom for collaborative work or special projects.
- Housekeeping Aides Closet – HAC

FA6, Staff Lounge, Lockers and Toilets: When suitable facilities will not be available within other services nearby, spaces area will be provided to accommodate staff breaks, and to provide staff toilets and lockers (for staff not assigned an office or cubicle). This functional area may include:

- Lounge, Staff
- Lockers, Staff
- Toilet, Staff

Special Requirements: Special requirements must be evaluated and applied on a project basis.

Functional Relationships

Organizational Concepts: The Functional Diagrams in Section 3 respond to functional, organizational, adjacency, and operational issues. They should not be interpreted as preliminary floor plans, because the diagrams do not correlate exactly to all the rooms and functions available in the Space Planning Criteria (<http://www.cfm.va.gov/TIL/planning.asp>), nor those required for every project.

General Planning Concepts

Security and continuity of service of IT systems is critical to the mission of VA. The Computer Area and Computer Support Area provide the essential data center functions. Key planning considerations for these areas are:

Flexibility: Changes in information technology systems and equipment requirements are certain to occur over the useful life the building. To ensure continuing adaptability, use of a standard planning module is encouraged. Refer to Section 4 of this Design Guide for the planning modules for the Main Computer Room and the Telecommunications Rooms.

- Modularity. Planning modules must accommodate standard sizes of IT equipment cabinets and racks, and must be compatible with the building structural grid and general planning module for the facility. See Guide Plates in Section 4.
- Scalability. Use of standard modules facilitates “scaling” the IT spaces to match systems requirements from very small (CBOC) to very large (major medical center) facilities.
- Expandability. Space criteria for IT areas were developed with the recognition that relocating or increasing the size of these spaces after initial construction and occupancy is difficult. Allowances for 50% spare or future capacity for IT equipment are included in the program areas. Whenever possible, plan for “soft” space (offices, conference rooms, etc.) on at least one side of the Main Computer Room. Consider installing access floor in the “soft” space to facilitate expansion of Main Computer Room.

Efficiency: VA is committed to the efficient use of resources (including energy, materials, equipment, and staff). Factors to consider in the design of OIT spaces include:

- Efficient or sustainable use of resources in construction, operation, and maintenance.
- Group or combine functions with similar system requirements. Refer to VA's Sustainable Design & Energy Reduction Manual (<http://www.cfm.va.gov/til/sustain.asp>).
- Efficiency in space and function.
- Share support spaces where possible.
- Avoid duplication.

Physical Security: Refer to VA's Physical Security Design Manual (<http://www.cfm.va.gov/til/spclRqmts.asp#PHS>) for detailed requirements.

- Location. Locate rooms that contain IT equipment so as to avoid exterior walls (unless hardened); adjacency to loading docks and mailrooms; and proximity to sources of electromagnetic interference, fire and smoke hazards, wet or high humidity locations, and patient care areas. Only systems (i.e., wet-pipe or clean agent fire suppression, electrical, energy management, etc.) that directly service the Demarc Room(s), the Main Computer Room, the Backup Computer Room, or Telecommunications Room(s) shall be allowed in the room (including inside adjacent walls), or on the floor directly above the room.

Technical Considerations

Accessibility (ABA)

Accessibility shall be accommodated by the application of the VA PG-18-13 Barrier Free Design Guide (<http://www.cfm.va.gov/TIL/accessibility.asp>), and ADA and ABA Accessibility Guidelines for Buildings and Facilities (<http://www.access-board.gov/ada-aba/final.cfm>), Appendices C and D to 36 CFR Part 1191 (adopted by GSA, and which supersede Uniform Federal Accessibility Standards (UFAS)) to accessible routes, and space and fixed equipment layouts.

Physical Security and Natural Disasters

Physical security is addressed by planning, design, and detail considerations. For definitions of Mission Critical and Life Safety Protected facilities and detailed requirements for each, refer to the VA Physical Security Design Manual (<http://www.cfm.va.gov/til/spclRqmts.asp#PHS>).

The Physical Security Design Manual restricts the location of the Main Computer Room, Backup Computer Room, and the Telecommunications Rooms. Additionally, these rooms shall be located above the Base Flood Elevation; shall not be located in patient care areas; and shall not be located beneath toilets, showers, laboratories, kitchens, sinks, open courtyards, planters, roof drain leaders, or other areas where water service is provided. Active voice, data, and special systems equipment is not allowed to be installed in elevator penthouses or mechanical rooms; dedicated rooms are required.

Any pipe or duct system foreign to the telecommunications installation shall not enter or pass through a room. The A/E shall ensure that foreign piping such as water pipes, steam pipes, medical gas pipes, sanitary waste pipes, roof drains, A/C ducts, and other unrelated piping systems containing liquids or gases are not installed in nor pass through rooms. Sprinkler piping shall not be routed through telecommunications spaces, unless it serves to protect the telecommunications installation.

Codes and Design Standards have established the probability of occurrence of natural phenomena, such as hurricanes, tornados, earthquakes, and floods, within regional areas. Design solutions shall address these probabilities where they occur, to mitigate building or IT systems damage, loss of IT service, and injury or loss of life wherever possible. Selection of building sites shall avoid floodplains or flood-prone areas. Regional areas susceptible to hurricanes shall incorporate design features that mitigate damage associated with high winds, and wind-driven rain and projectiles. Design for tornado damage mitigation is similar to that for hurricanes, though much more localized and intensive in nature. Buildings in areas with probability of earthquakes must be seismically restrained in accordance with VA's H-18-8 Seismic Design Requirements (<http://www.va.gov/facmgt/standard/seismic.asp>). Design and installation of non-structural elements and equipment in VA facilities in seismic areas shall comply with the latest editions of the following:

- International Building Code (IBC), International Conference of Building Officials
- VA's H-18-8 Seismic Design Requirements (<http://www.va.gov/facmgt/standard/seismic.asp>)
- VA's Master Construction Specifications (<http://www.cfm.va.gov/TIL/spec.asp>), Section 13 05 41, SEISMIC RESTRAINT REQUIREMENTS FOR NON-STRUCTURAL COMPONENTS

Architectural

Exterior Construction: Selection of building envelope and enclosure systems shall follow guidance in VA's PG-18-10 Architectural Design Manual (<http://www.cfm.va.gov/til/dManual.asp>).

Interior materials and finishes and doors should follow the information in the Guide Plates. The Guide Plate for each space includes a listing of design criteria applicable to that space. Where a specific guide plate is not provided for a space or function, refer to the general design information below, VA's PG-18-10 Architectural Design Manual, and VA's PG-18-14 Room Finishes, Door, and Hardware Schedule (<http://www.cfm.va.gov/til/room/RoomFinishes.pdf>). Coordinate selections with Interior Design and Wayfinding.

Security: Partitions, doors, and hardware for Demarc Rooms, Main and Backup Computer Rooms, Antenna Headend Equipment Room, Telecommunications Rooms, and other sensitive IT spaces have special security requirements. Refer to Room Guide Plates, VA's Physical Security Design Manual (<http://www.cfm.va.gov/til/spclRqmts.asp#PHS>), and VA's Design and Construction Procedures (<http://www.cfm.va.gov/TIL/cPro.asp>), Topic 14: "Security."

Interior Design: The goal of the design is to provide an interior environment that is respectful of the public monies, promotes staff performance, and expresses progressive high quality design. Designs that narrow choices of procurement furnishings are inappropriate. Materials in colors, patterns, and designs that transcend time are endorsed. Trendy colors and patterns are to be restricted to cycle replacement materials, such as paint and wall coverings. Refer to VA's Interior Design Manual (<http://www.cfm.va.gov/til/dManual.asp>) for additional information.

Signage and Wayfinding: Wayfinding is thought of broadly as building elements and color, texture, and pattern cues, as well as a coordinated concept established for signage and artwork. Signage and wayfinding for OIT is to be integrated with the overall concept for the facility. Refer to VA's Interior Design Manual (<http://www.cfm.va.gov/til/dManual.asp>), and VA's Signage Design Guide (<http://www.cfm.va.gov/til/spclRqmts.asp#SIGN>).

Partitions should primarily be gypsum wallboard on 4-inch metal studs. Provide sound attenuation in accordance with VA's PG-18-3, VA Design and Construction Procedures (<http://www.cfm.va.gov/TIL/cPro.asp>), Topic 11: "Noise Transmission Control." Provide fire and/or smoke-resistant construction where required.

Provide wall and corner guards in corridors and other areas where wall damage from cart traffic is anticipated. Provide plywood lining on partitions where indicated in the Guide Plates. Plywood should be A/C grade or better, void-free, 8 feet high with a minimum thickness of $\frac{3}{4}$ inch. To reduce warping, plywood should be kiln-dried to a maximum moisture content of 15 percent. Plywood should be treated on all six sides with light colored, fire-retardant paint. Mount plywood with bottom edge at 12 inches AFF with good face exposed.

Finishes should be a light color.

Floors in most spaces should be vinyl or vinyl composition tile with a 4 inch high rubber base. Rooms containing IT equipment shall have static-dissipative flooring as indicated in the Room Guide Plates. Floors in offices, conference rooms, and waiting areas should be carpet with a 4 inch high rubber base. Floors in toilet rooms should be ceramic tile with a ceramic tile base.

When provided, access floors shall be of "bolted stringer design." The access floor shall meet the following minimum performance specifications:

Table 2.1 Access Floor Minimum Performance Specifications

Uniform load	250 lbs psf
Concentrated	1,000 lbf
Overturning moment	1,000 lbf x inches
Axial load	5,000 lbf
Impact load	100 lbf

Local and overall surface deformation shall not exceed 0.40 inch. Flat floor panels shall consist of a high-density particleboard wood core laminated to top and bottom face sheets of zinc-coated steel. Perforated panels shall be of all-steel construction and shall be interchangeable with flat panels. Finish flooring shall be static-dissipative, high pressure laminate surface with integral perimeter edging. The floor panel size shall be 24 inches by 24 inches. Edges of cut-out panels shall be provided with self-extinguishing foam rubber seals. An additional 20% of each variety and color, including cutout and perforated vent panels, shall be provided as spares. The supporting structure and “stringers” shall be connected to the equipotential ground system with a minimum #2 AWG stranded copper wire.

Water and smoke detection devices are required beneath the access floor. The structural floor shall be thoroughly cleaned and sealed prior to the installation of the access floor.

Consideration must be given to preventing air dams under the access floor; to preventing airflow short-cycling; to proper selection of perforated floor tiles, which direct airflow to front of cabinets; and to sealing all penetrations of the access floor.

If the access floor cannot be installed flush with adjoining finish floors, provide a minimum of one main pedestrian entry ramp from a corridor. The ramp shall be a minimum of 6 feet wide. The ramp shall meet accessibility standards with a maximum slope of 1:12, and a minimum 7 feet x 6 feet clear, level landing at the bottom. The ramp shall be covered with rubber flooring with a raised circular disc pattern (or equal), and shall have a minimum 800 pound force rolling load limit capacity.

Ceilings in most spaces, including toilet rooms, are lay-in acoustic ceiling tile. Where required for sanitation or moisture resistance, acoustical ceiling tile should have a washable plastic (Mylar) finish. Minimum ceiling heights should be as indicated in the Room Guide Plates. Refer To VA’s PG-18-3 Design and Construction Procedures (<http://www.cfm.va.gov/TIL/cPro.asp>) if a guide plate is not provided for a particular room or function.

In the Main Computer Room and other rooms containing IT equipment, the ceiling finish should minimize dust and be light colored to maximize light reflectance. Acceptable products include “Clean Room” type or Mylar-faced panels in an aluminum suspension system. Layout of the ceiling grid should align with the access floor system. Suspended ceilings are not recommended in the Demarc Room(s), Telecommunications Room(s), and Antenna Headend Equipment Room.

Interior doors shall be 1-3/4 inches thick, solid core, flush wood doors or hollow metal doors in hollow metal frames. Hollow metal doors should be used where high impact is a concern and where fire-rated doors are required. Kick/mop plates should generally be applied to both sides of the doors. Provide single or double leaf doors as indicated on the Guide Plates. Doors shall be 7

feet high and 3 feet minimum width. Provide greater door widths when indicated on the Guide Plates.

Hardware: Accessible type shall be used throughout. Refer to VA's PG-18-14 Room Finishes, Door, and Hardware Schedule (<http://www.cfm.va.gov/til/room/RoomFinishes.pdf>) for additional information.

Fixed Equipment: Equipment Lists are provided with the Guide Plates in Section 4. Additional general information and guidance may be available in VA's PG-18-5 Equipment Guide List (<http://www.cfm.va.gov/TIL/equip.asp>). Refer to equipment manufacturers' data for information specific to a particular equipment item.

Casework: For planning and utilization concerns, casework systems should be chosen for their flexibility. Casework systems should incorporate components dimensioned for ease of multiple re-use installation applications. Casework systems should be planned to avoid corner installations and filler panels.

Fire Protection

Follow criteria in the VA Fire Protection Design Manual (<http://www.cfm.va.gov/til/dManual/dmfpfire.pdf>).

The Public Buildings Amendment Act (PL 100-678) requires all Federal agencies to follow the latest editions of nationally recognized fire and life safety codes. VA has adopted the National Fire Codes (NFC), except NFPA 5000, published by the National Fire Protection Association (NFPA). Life safety requirements are specifically addressed in the Life Safety Code, NFPA 101.

Fire protection features not addressed by the NFC shall be designed to comply with requirements of the latest edition of the International Building Code (IBC). For guidance on compliance with other Codes and Standards, refer to VA's PG-18-3 Design and Construction Procedures (<http://www.cfm.va.gov/TIL/cPro.asp>), Topic 1: "Codes, Standards, and Executive Orders."

Fire sprinkler mains shall not be routed through IT spaces within the Computer Area or the Computer Support Area. Only fire sprinkler branch lines serving these spaces shall be permitted therein. Exception: If the entire building is comprised of the Computer Area or Computer Support Area or a combination thereof.

Provide an automatic wet-pipe sprinkler system throughout the building, including all Demarc Rooms, Main Computer Rooms, and Telecommunications Rooms. Note: Standard response fusible link sprinklers are permitted to be used in the Computer Area. These sprinklers will lessen the chance of a sprinkler being accidentally broken and will still provide structure protection since a standard response head is more robust and harder to break than a typical glass bulb quick response sprinkler.

In addition, provide clean agent fire suppression for the Main Computer Room and Backup Computer Room when required by the VA Fire Protection Design Manual.

EMI/RFI and Environmental Factors

IT equipment can be sensitive to electromagnetic and radio frequency interference (EMI/RFI). Maintain minimum of 20 foot separation (horizontally and vertically) from any high-induction electrical sources, i.e., electrical transformers, large motors, generators, radio transmitters, induction heating devices, photocopying equipment, radiology machines, variable frequency drives, and arc welding equipment.

Rooms shall be located so as to minimize effects of lightning strikes and sunlight radiant heating.

Energy Conservation and Sustainable Design

The need to conserve energy is mandated by the Federal Government by both Executive Order and Federal Law. In addition, 19 Federal Agencies, including VA, have signed a Memorandum of Understanding (MOU) outlining specific goals and targets for energy conservation and sustainable design. Refer to VA's Sustainable Design & Energy Reduction Manual (<http://www.cfm.va.gov/til/sustain.asp>), and VA's PG-18-10 HVAC Design Manual (<http://www.cfm.va.gov/til/dManual.asp>).

Heating, Ventilation, and Air Conditioning

Operation: Air conditioning systems should be provided to heat, cool, and ventilate the individual spaces, as required by the criteria in VA's PG-18-10 HVAC Design Manual (<http://www.cfm.va.gov/til/dManual.asp>). Design conditions for rooms housing IT equipment are shown in the Design Standards in Section 4 of this document.

Capacities: The A/E shall verify the actual occupant and equipment load for each project. Note that the active equipment cabinets and racks installed in the Main Computer Room and Telecommunications Rooms are planned with 50% spare capacity.

The percent of outside air should be based on the space total supply air quantities.

Noise Class: Select HVAC equipment, ductwork, and listed distribution devices to achieve noise levels listed in VA's PG-18-10 HVAC Design Manual (<http://www.cfm.va.gov/til/dManual.asp>), and VA's Master Construction Specifications (<http://www.cfm.va.gov/TIL/spec.asp>) Section 23 05 41, NOISE AND VIBRATION CONTROL FOR HVAC PIPING AND EQUIPMENT.

Main Computer Room (Data Center) Air Conditioning: The IT and HVAC industries have recognized the inefficiencies of mixing of the hot air exhausted off the rear of each IT cabinet with the cooled air in the overall space. While there is no single HVAC solution that is appropriate for all data centers, the preferred method of limiting this inefficiency is to separate and contain the supply and return airstreams. Cold air is supplied by the Computer Room Air Conditioner (CRAC) unit(s), ducted to under the access or raised floor, and allowed to rise through perforated floor tiles and through the front of the cabinets in the "Cold Aisle." This method is "Cold Aisle Containment" (CAC). "Hot Aisle Containment" (HAC) provides a vertical duct at the top and rear of specialized IT cabinets, which allows the exhaust of hot air directly back to the CRACs via above-ceiling ducts.

Consideration must be given to the volume of cold-aisle-to-hot-aisle airflow through the cabinets to ensure acceptable air pressure on the IT equipment; to preventing air dams under the access floor; to preventing airflow short-cycling; to proper selection of perforated floor tiles, which direct airflow to front of cabinets; to sealing all penetrations of the access floor; and to the use of vertical

filler panels within cabinets to maintain vertical airflow. Airflow computational fluid dynamic analyses may be required. For more information, see ASHRAE Datacom Equipment Power Trends and Cooling Applications, ASHRAE Thermal Guidelines for Data Processing Environments, and ANSI/TIA-942 – Telecommunications Infrastructure Standard for Data Centers. These concepts are illustrated by the following airflow diagrams:

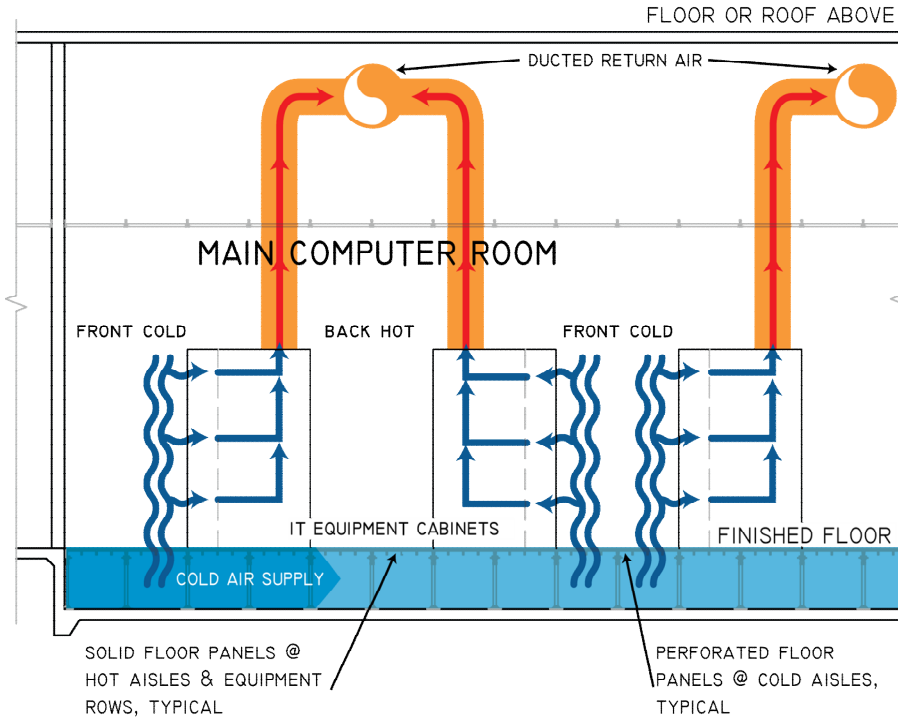

Figure 2.1 Main Computer Room Longitudinal Section

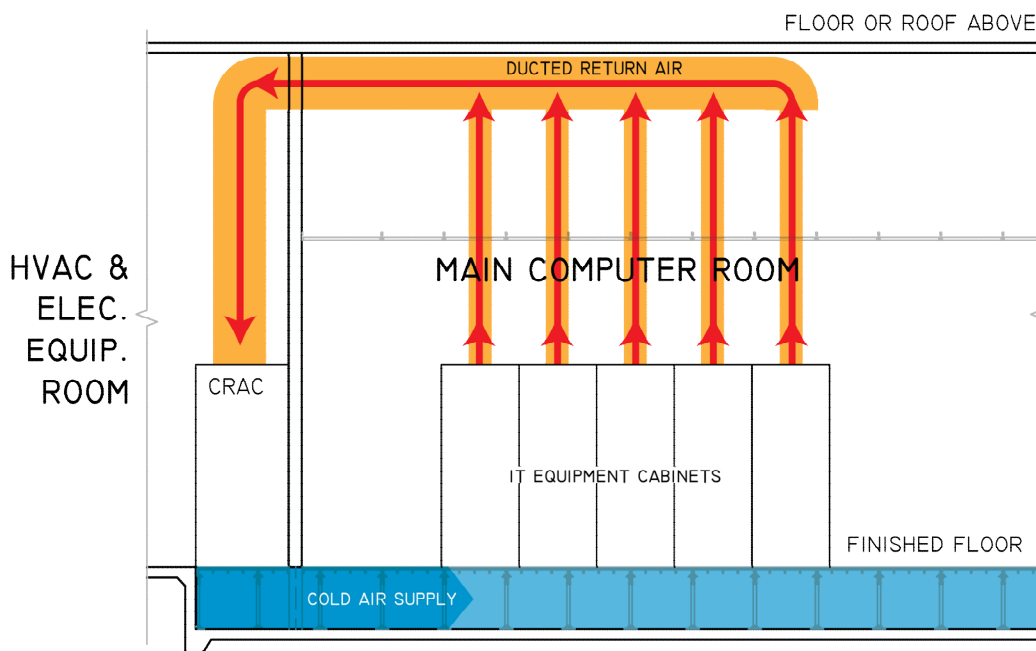

Figure 2.2 Main Computer Room Transverse Section

Plumbing

Water and waste system piping, rainwater leaders, heating water and steam piping, chilled water piping, condensate drain lines, and all other piping systems for pressurized or gravity-fed liquids and gasses shall not be permitted to be routed through, above, or in the walls encompassing the Demarc Room, Main Computer Room, Backup Computer Room, Telecommunications Rooms, and Antenna Headend Equipment Room.

Electrical

Comply with the lighting, power, grounding, and electronic security requirements of VA's Electrical Design Manual (<http://www.cfm.va.gov/til/dManual.asp>).

Building lighting energy expenditures comprise a significant component of overall building energy use. The lighting systems shall comply with VA's Sustainable Design & Energy Reduction Manual (<http://www.cfm.va.gov/til/sustain.asp>).

Lighting for rooms containing active and passive IT equipment:

- Dimmers are not permitted.
- Coordinate light fixture placement with cabinet, rack, and aisle locations, HVAC equipment and duct locations, overhead conduit penetrations and cable tray routes.

General Power duplex or quadruplex receptacles are typically provided on each wall of a room or a space where power is required. Refer to Guide Plates in Section 4. Workstations with personal computers are typically provided with quadruplex receptacles for the PC and auxiliary equipment.

Emergency Power requirements are addressed in VA's Electrical Design Manual (<http://www.cfm.va.gov/til/dManual.asp>) and the Guide Plates in Section 4.

Uninterruptible Power Supply (UPS) requirements are addressed in VA's Electrical Design Manual (<http://www.cfm.va.gov/til/dManual.asp>) and the Guide Plates in Section 4.

Waste Management

General waste is generated in all spaces. Coordinate collection, sorting, and disposal with Environmental Management procedures.

Recycling: Methods for sorting, collecting, transporting, and disposing of recyclable products must be coordinated with Environmental Management procedures.

Production and holding of waste or recyclable materials should be minimized in the Computer Area and Computer Support Area to reduce risks to IT equipment from fire or smoke.

Space criteria in VA's PG-19-9 Space Planning Criteria (<http://www.cfm.va.gov/TIL/planning.asp>), Chapter 232 – Office of Information & Technology, provide space for holding of waste and recyclable materials in the Receiving / Breakdown Room in the Computer Support Area. This is where computers and other IT equipment are unpacked when received from warehouse or vendor.

Circulation Systems

Staff access should be separated from patient entries, waiting, and holding areas. Staff lounge and locker areas should be located away from patient traffic.

Materials and equipment should be transported to and from loading dock and functional areas by service elevators, and through corridors separated from patient traffic whenever possible.

Data Service Reliability

The Uptime Institute has developed a system for classifying the expected reliability of data centers and computer rooms based on how the rooms were constructed, types of equipment used, and how services were delivered. Four Tier levels were designated and high-level characteristics, along with expected reliability for each Tier, are listed below:

- Tier I – Tier I is composed of a single path for power and cooling distribution, without redundant components, providing 99.671% availability.
- Tier II – Tier II is composed of a single path for power and cooling distribution, with redundant components, providing 99.741% availability.
- Tier III – Tier III is composed of multiple active power and cooling distribution paths, but only one path active, has redundant components, and is concurrently maintainable, providing 99.982% availability.
- Tier IV – Tier IV is composed of multiple active power and cooling distribution paths, has redundant components, and is fault tolerant, providing 99.995% availability.

The A/E should be familiar with the concepts involved and incorporate as many of the specific Tier III requirements into the Main Computer Room design as practical.

When a telecommunications system is intended to be connected to facility's local- or wide-area network (LAN/WAN) that contains a Nationally Coded functional rating (i.e., Telephone Systems are Nationally Rated as "Critical Service" and are upgraded to "Life Safety/Support" when the Telephone System is controlling the facility's Code Blue Function; Nurse Call Systems are ranked as "Emergency" and Code Blue is ranked as "Life Safety/Support;" Police Radio Systems are ranked as "Emergency;" PA Systems are ranked as "Public Safety" and raised to "Life Safety/Support" when carrying Code Blue Signals, etc.), then the facility LAN/WAN's functional rating must be upgraded to be as Nationally Rated as the connecting and connected system(s). If the LAN/WAN is not able to function in the enhanced ranking environment, the intruding system **MUST NOT** be connected to the LAN/WAN until it can be shown to meet the appropriate National Code Ranking. The A/E shall contact VA Telecommunications Engineering (TE-005OP2H3) at 301-734-0376 for direction and assistance with these functional and code ratings.

Voice Systems Minimum Operational Requirements

Voice System Levels of Reliability:

- Level I (200 Lines Plus 50% Growth): Level I facilities do not require a high level of circuit availability. Although a voice system failure would impact mission performance, simple alternative methods of communications could be utilized during a voice system failure. Examples of facilities that would be classified as Level I would include: Veteran Centers, National Cemeteries, and small administrative facilities supporting 50 or fewer employees. Consideration shall be given to the type of mission the facility supports. A large mission-

critical Call Center or Patient Call Center is an administrative space that could be classified at a higher lever even though it meets the criteria above.

- Level II (500 Lines Plus 50% Growth): Level II facilities require a high level of circuit availability, and may utilize their systems for life safety purposes when critical care areas are present or when specific conditions exist (i.e., the inclusion of certain procedure rooms). Examples of Level II facilities include Community Based Outpatient Clinics (CBOCs) and large administrative facilities supporting 50 or more employees, where a voice system failure would have a major impact on mission performance.
- Level III (1,000 Lines Plus 50% Growth): Level III facilities use voice systems that are NFPA Life Safety Code Certified/Listed for Critical Service for Life Safety and Critical Care. Level III establishes the standard for high level of circuit availability. A Level III example would be a telephone system used for calls and managing Code Blue (Code One) at a Medical Center. Other Level III facilities may include standalone CBOCs and Outpatient Clinics (OPCs) that receive a large volume of voice traffic directly related to the health and well-being of veterans, or large administrative or patient call centers where a voice system failure would have a major impact on mission performance.
- For Level III function, the voice system shall, at a minimum, operate in accordance to VA's Master Construction Specifications and applicable codes and standards. At a minimum, the Digital Telephone (PBX) Voice System or VoIP Voice System shall maintain minimum circuit availability based on Mean Time Between Failures (MTBF) Rates per Annum as follows:

Table 2.2 Mean Time Between Failures

Availability in Percent (%)	Downtime per Year	Downtime per Month	Downtime per Week
99.9 %	8.76 hours	43.2 minutes	10.1 minutes
99.999%	5.26 minutes	25.9 seconds	6.05 seconds

Voice System Minimum Service Grade:

- The voice system shall be engineered to provide a minimum Poisson Traffic Grade of Service (P.01) with an average circuit load of 7.0 Centum (or hundred) Call Seconds (CCS) per station per hour. The average CCS capacity per voice station shall be maintained at 7.0 CCS when the voice system is expanded to its projected maximum growth.
- Plain Old Telephone (POTS) voice system is defined as a Dual-Tone Multiple Frequency (DTMF) Public Branch Telephone Exchange (PBX) managed system, and which shall meet a minimum MTBF of 99.9%.
- Voice over Internet Protocol (VoIP) voice system is defined as a digital call managed (non-PBX) system, and which shall meet a minimum MTBF of 99.999%.

Main Computer Room

Modular Design: The spaces within the Main Computer Room are planning modules designed to accommodate active and passive equipment cabinets and racks, conduit entries, and associated circulation and equipment access space. Each space has a governing set of criteria.

There will be separate entrances to the FMS and OIT areas. The MCR shall be functionally divided into OIT space and FMS space by a non-removable fence which extends from the floor slab to structure above. The fence should not restrict airflow.

Main Computer Room Sizing is based on the size of the facility served.

For a given project, OIT will provide active equipment network design, and will confirm quantity of Rack Units (1U, or unit = 1.75 inches of vertical mounting space in an enclosure) of active equipment. This design will modify the sizing of the spaces that make up the Main Computer Room. The area allocated for each space (each space is further described below) will be normalized during design, such that the result is Main Computer Room of uniform width and that meets the functional and spatial requirements described herein. The nominal space sizes defined in the Space Planning Criteria Chapter 232 are individually based on facility NSF, and are to be adjusted during design into a homogenous Main Computer Room.

The number of Us for passive fiber terminations are determined by the quantity of TRs. The quantity of TRs is defined by the building gross square footage served by the MCR.

The quantity of CRAC units is based on the heat produced by the quantity of active equipment, the configuration of the UPS system (i.e., standalone floor mounted UPS or individual system UPSs mounted in enclosures) and the configuration of enclosures and their associated hot and cold aisles.

In deriving the number of active equipment cabinets, assume two active MCR ports per 125 NSF nominal room (one voice, one data), and 600 ports per cabinet. A cabinet can support 1200 ports, and OIT wishes to fill each cabinet to 50%. The number of nominal rooms in a facility is the BGSF divided by 2 (grossing factor), and then divided by 125 NSF (room size).

Each row of active equipment is served by a UPS, which occupies one cabinet footprint. Rows of racks for passive distribution equipment do not require UPSs. The panelboard-level branch circuit distribution for UPS output power is housed in the adjacent HVAC and Electrical Equipment Room, Computer Area.

From each TR, 96 fiber strands reach the MCR: a 48-strand trunk for OIT, and a 48-strand trunk for FMS. The fibers will be single-mode (12 strands), multi-mode (12 strands), and laser-optimized multi-mode (24 strands), as defined in the Division 27 Master Construction Specifications. Each 48-strand trunk will terminate on one Fiber Distribution Unit (FDU), which will occupy two Rack Units (2U). One FDU contains four connector housings, each of which can terminate 12 strands of fiber.

The fibers from seven TRs (7 x 48 strands) will occupy one MCR rack for each service (OIT and FMS). Therefore, two racks, one OIT, and one FMS, are required to house the 14 FDUs necessary to terminate all of the fiber from one TR. OIT fiber will terminate on racks in the OIT IT Passive Distribution Equipment area in the MCR; FMS fiber will terminate on racks in the FMS Passive Distribution Equipment area in the MCR.

Rows of cabinets and racks are pushed to one wall of the MCR. There will not be circulation space around both ends of a row.

OIT IT Active Equipment Area: The active equipment in cabinets in this area will be cross-connected to the OIT IT Passive Distribution Equipment Area. One MCR cabinet will accommodate 1200 active ports at full buildout, though 50% fill is assumed for planning purposes. Therefore, each active equipment cabinet will serve 600 active ports.

Each piece of active equipment is assigned a maximum quantity of ports, and it assigns an IP address to a given jack via its physical ports. Although there will be multiple jacks cabled to and terminated in a Telecommunications Room, it is assumed only one jack is active and physically mapped to a server port in the Main Computer Room.

OIT IT Passive Distribution Equipment Area:

This area contains the racks which terminate and cross-connect OIT fiber backbone cables from the MCR to the TRs (Telecommunications Rooms). The size of the area is based on the quantity of TRs fed from the MCR, and the quantity of OIT fiber backbone cables distributed to each TR from the MCR.

The termination racks are configured in rows. Racks are separated by two vertical wire managers, with an additional pair of vertical wire managers at each end of the row. Equipment overhang allowances are 12 inches in front and 18 inches in rear, for a total rack depth of 36 inches.

At initial design, each rack is assumed to be filled to 50%. An 84" rack with 78.75 inch (or 45U) of available space is limited to 23U of space for passive termination equipment.

The basis of design for termination space on the racks is that each TR will be served by a 48-strand OIT fiber backbone, or trunk, which terminates on the OIT side of each TR. Actual strand counts must be verified with OIT during system design. In the OIT IT Passive Distribution Equipment area, each 48-strand trunk terminates on one dedicated 2U, 4-connector housing Fiber Distribution Unit (FDU). There is one 1U horizontal wire manager at the top and bottom of the FDU stack, and one 1U horizontal wire manager between each 2U FDU. This allows installation of seven FDUs in an 84" rack, and therefore the termination of seven TRs on a single rack.

FMS Active Equipment Area: At a minimum, the Main Computer Room shall contain space for the following FMS active equipment:

Nurse Call	½ cabinet
Code One (Blue)	½ cabinet
Security TV (SSTV)	½ cabinet
Overhead Paging	½ cabinet
Security Management	1 cabinet (includes duress alarm, motion intrusion detection, and access control)
EMS (or EMCS)	1 cabinet
Fire Alarm (and MNS)	½ cabinet (if approved by VISN Safety Officer and local fire department)

- Notes:
1. The above includes space for cabinet-mounted UPS equipment.
 2. FMS determines whether the above systems require additional space.
 3. FMS determines whether host servers are located in the MCR, the TR, or both.
 4. Additional systems may be required by FMS.

Each FMS active equipment row in the MCR should include room for two spare cabinets. The FMS passive distribution rows should not contain space for spare cabinets; these cabinets will be filled to 50%.

FMS Passive Distribution Equipment Area: This area contains the racks that terminate and cross-connect FMS fiber backbone cables from the MCR to the TRs. The size of the area is determined identically to the OIT IT Passive Distribution Equipment area.

Voice Service shall be either VoIP, or digital telephone (PBX), as determined by OIT. Regardless of the selected voice solution, there shall always be a quantity of POTS (Plain Old Telephone System) copper pairs to be distributed from MCR to each of the TRs, although this quantity is significantly less for a VoIP voice solution.

VoIP Active Equipment Area: This area includes VoIP active equipment and UPS cabinets, and wall-mounted passive distribution equipment for copper backbone (110 termination blocks).

Digital Telephone (PBX) Equipment Area: This area includes PBX active equipment and UPS cabinets, and wall-mounted passive distribution equipment for copper backbone (110 termination blocks).

Telecommunications Rooms

Quantity and Location: A minimum of one Telecommunications Room (TR) per floor is required, as is a minimum of one Telecommunications Room per 15,000 square feet of building gross floor area served. Multiple Telecommunications Rooms are required if the horizontal cable length, routed parallel and perpendicular to the building geometry, between the Telecommunications Room and the furthest telecommunications outlet exceeds 262 feet (80 M). The overall cable length is limited to 328 feet (100 M), but the 262 feet (80 M) horizontal limit allows for 15 feet (4.6 M) of station cabling in the work area from the telecommunications outlet to the field network device, 15 feet (4.6 M) of jumper cable in the Telecommunications Room for jumper cables from the patch panel to the active equipment, and 30 feet (9.1 M) of combined vertical rise at both ends.

It is suggested that a Horizontal Cable Distance Study be used to define Telecommunications Room locations. The study locates the TR in the proposed location and draws four straight 262 foot (80 M) lines originating at the center of the room, to the north, south, east and west, and then connects the ends of the four lines together, creating a "diamond," with the proposed TR location at the center. See Figure 2.3. The proposed TR location and resulting diamond coverage area is then moved around the floor plate until all areas of a given floor are within a diamond. This ensures that all areas are within the maximum allotted cable distance.

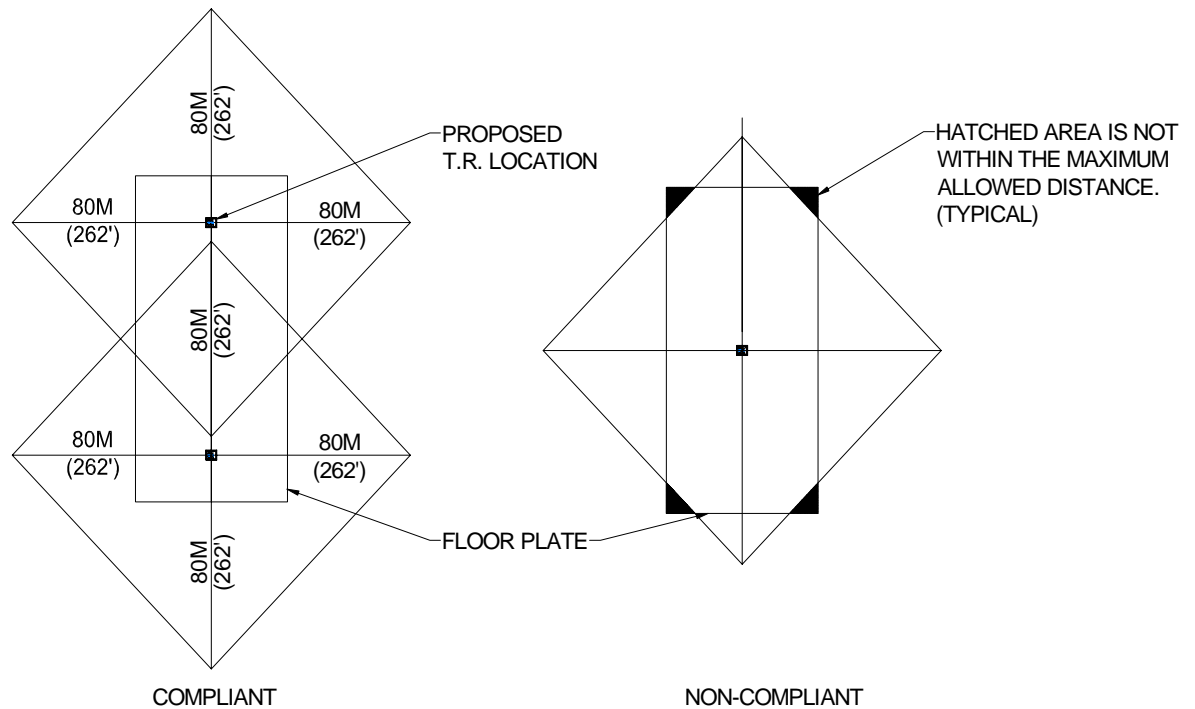

Figure 2.3 Sample Horizontal Cable Distance Study

Telecommunications Rooms shall be aligned vertically (stacked) on multi-floor buildings.

Telecommunications Rooms shall not be located next to large mechanical rooms, electrical rooms, and/or pipe and duct chases, stairwells, and elevator shafts and equipment rooms that would limit cable tray accessibility. Locating a Telecommunications Room's walls over floor or ceiling beams forces vertical floor-to-floor conduits to be pushed further out into the room. To avoid beams, locate walls so as to facilitate vertical conduit riser locations.

TRs should not be located less than 20 feet horizontally and vertically from any EMI/RFI-producing high-induction electrical sources, i.e., electrical transformers, large motors, generators, radio transmitters, induction heating devices, photocopying equipment, radiology machines, variable frequency drives, and arc welding equipment.

Equipment not related to the service or support of the IT equipment shall not be located in nor pass through the TR.

Refer to the VA Electrical Design Manual for a minimum schedule of conduits connecting the MCR to the bottom-most TR in a stack, fiber and copper backbone cabling connecting the MCR to each TR, and sleeves from TR to TR. OIT conduits shall enter the OIT side of the TR, and FMS conduits shall enter the FMS side of the TR.

Maintain continuous and dedicated environmental control (i.e., 24 hours per day, 365 days per year). If emergency power is available, connecting room HVAC to emergency power. Maintain positive pressure with a minimum of one air change per hour. As part of the building energy management system, the TR HVAC system shall be alarmed for power loss, high and low temperature, high and low humidity, smoke detection, HVAC unit compressor failure (if applicable), and water flooding. Provide a water pan or barrier around the HVAC system to

ensure water does not leak into the room as opposed to drain, with a set of alarm contacts in the water pan.

The TRs shall be functionally divided into OIT space and FMS space. An optional barrier with keyed gates (sliding or hinged) may be provided. The barrier may be removable.

On the interior perimeter walls, TRs are provided with 12 inch deep space for wall-mounted equipment, plus 36 inches of clearance to front and rear of racks.

Racks: Each TR should be equipped with four open racks; two each on the OIT side and two each on the FMS side of the divided room. On each side, one rack is for horizontal passive distribution equipment, i.e., patch panels for horizontal cabling. The other rack on each side is for active distribution equipment and termination of fiber backbone cable. .

Double (front and rear) vertical wire managers are installed between each rack, allowing the rear vertical wire manager to be used for distribution of cables to back of patch panels from field TCOs, and the front vertical wire manager to be used for the distribution of cables from the front of the patch panels to the active distribution equipment mounted in the active distribution rack.

OIT Passive Distribution Equipment: The OIT passive distribution rack will be filled to a maximum 50% fill during initial design, and will contain up to seven 48-port non-angled patch panels. Patch panels are separated by 2U horizontal wire managers. The 100-pair copper backbone cable is terminated on wall-mounted termination blocks.

Each rack is a minimum of 84 inches tall, of which 78.75 inches (or 45U) is available. At 50% maximum fill, there is 23U available for initial use. For purposes of calculating passive termination space, it is assumed that four Category 6 horizontal cables from one telecommunications outlet (TCO) per 125 NSF of floor area served will be terminated; one for voice, and three for data. Of these four cables, two are active ports (one voice, one data; see also Main Computer Room section of this Design Guide). It is assumed that a grossing factor of 2 results in 7,500 NSF of area served from 15,000 BGSF, and that a nominal room served is 125 NSF, with four horizontal cables from it to the TR. This results in 60 nominal rooms served per TR, or 240 horizontal cables.

OIT IT Active Equipment: The OIT active distribution rack will be filled to a maximum 50% fill during initial design. Typically, all OIT active equipment is powered by VA-provided, VA-installed rack-mounted UPS equipment. This equipment can be a single UPS serving all active equipment in the rack, or individual UPSs to serve individual active equipment components.

The rack will contain one 2U fiber distribution unit (FDU), which contains four 12-port connector housings that will terminate 48 fiber strands (OIT backbone from MCR).

FMS Active and Passive Equipment: The two FMS racks may be filled to a maximum 50% fill during initial design. FMS passive distribution includes one 2U fiber distribution unit (FDU), containing four 12-port connector housings that will terminate 48 fiber strands (FMS backbone from MCR). The remaining portion of the 50% fill in each rack may contain termination components, active equipment, UPS equipment, rack-mounted headend equipment, etc.

Typically, each active FMS system requires a dedicated rack-mounted UPS, fed by a dedicated 120V circuit. At worst case, and fill of 23U, there could be eleven 120V circuits required for the FMS active equipment.

A 12 inch deep mounting space on the perimeter walls is intended for FMS wall-mounted headend equipment and control panels. Careful arrangement of panel door swings and vertical stacking should allow for maximum use of this space.

Remote Telecommunications Rooms

Small outbuildings and remote non-critical areas of mission-critical buildings shall be permitted in special circumstances to be served by an environmentally-controlled telecommunications cabinet in lieu of a Telecommunications Room. Contact VA Telecommunications Engineering (TE-005OP2H3) at 301-734-0376 for project-specific assistance in determining where these cabinets may be used.

Existing Facilities

Telephone Equipment Rooms: Current practice is to locate the main telephone equipment in Main Computer Room. However, at many existing Medical Centers, the main telephone equipment is often housed separately in a Telephone Equipment Room. This room may also contain air conditioning equipment, a battery plant, and the incoming demarc(s). It is recommended that renovations of existing Telephone Equipment Rooms, or construction of a new Telephone Equipment Room, should follow the Main Computer Room design guidelines in this document. A Telephone Equipment Room Guide Plate is provided in Section 4.

This page intentionally left blank.

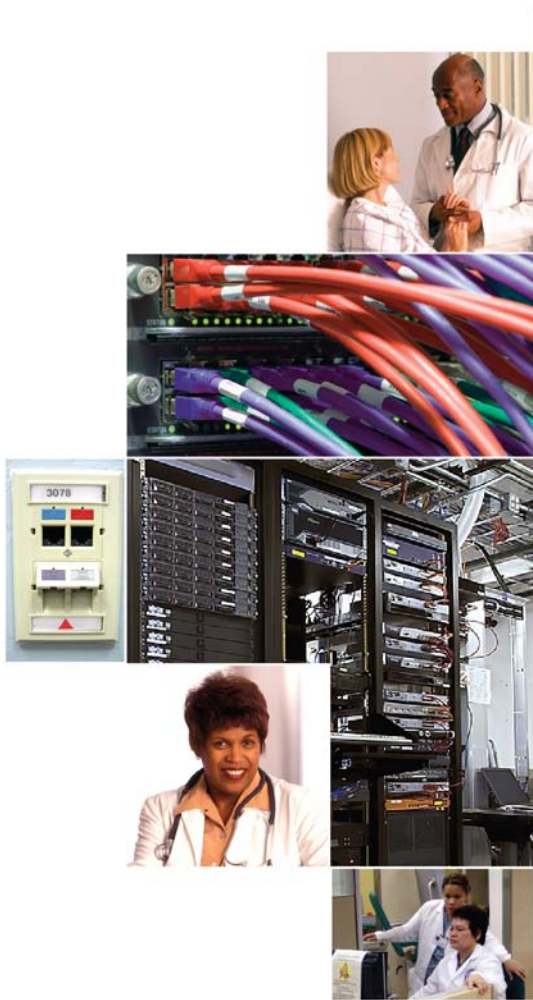

Section 3

Functional Diagrams

	Page
General Considerations	3-1
Legend for Functional Diagrams	3-1
Functional Diagram, OIT	3-2
Functional Area Diagrams	
Reception Area	3-3
Computer Area.....	3-4
Computer Support Area	3-5
Telecommunications Support Area.....	3-6
Staff and Administrative Area	3-7
Staff Lounge, Lockers and Toilets	3-8
Functional Relationships Matrix	3-9

This page intentionally left blank.

General Considerations





Information technology systems and equipment can be anticipated to change during the life of the building in response to new developments in technology and evolving medical programs. In order to facilitate changes and minimize remodeling, the use of modular spaces and designs is encouraged. The diagrams in this section illustrate typical concepts applicable to the design and development of space for OIT.

The first diagram illustrates the relationships for the six functional areas as defined in Space Planning Chapter 232, Office of Information & Technology. The following six diagrams are provided to illustrate the relationships for the spaces within each of the functional areas.

Functional diagrams represent key adjacencies and hierarchies between the functional areas and significant spaces as defined by the Program for Design. They are not intended as suggested floor plans or layouts. The blocks representing functional areas or spaces are generally proportional, but are not drawn to scale. Space allocations for a particular project shall be in accordance with the project's approved Program for Design. The A/E is responsible for final space layouts.

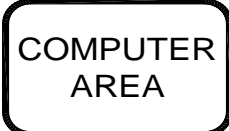
Section 4, Design Guide Plates, Design Standards, and Equipment Lists, includes plan layouts for key rooms or areas within OIT.

Legend for Functional Diagrams

	Functional area (Used in Functional Diagram)
	Adjacent functional area (Used in Functional Area diagrams)
	Room within a functional area
	Designates subdivision within a room

Functional Diagram OIT

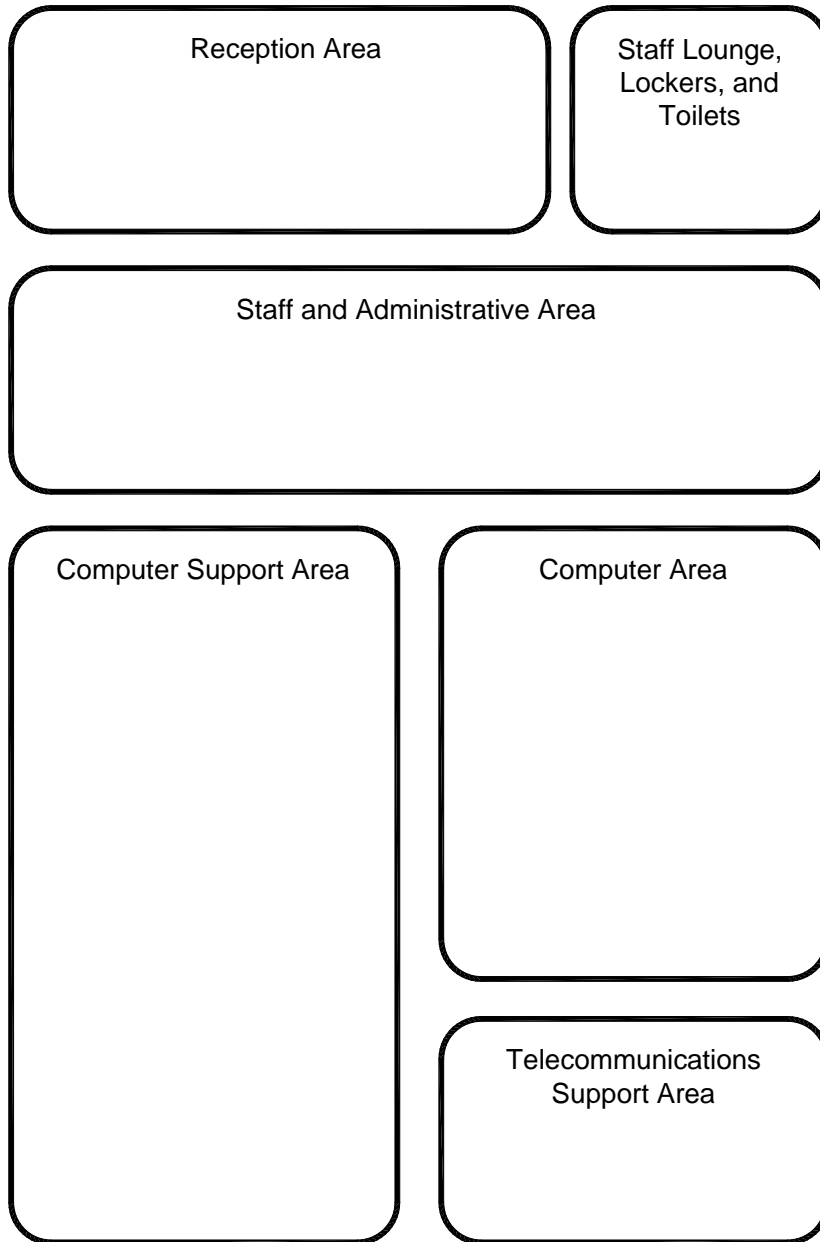

This diagram illustrates typical relationships for the six functional areas within OIT.

Functional Area Diagram

Reception Area

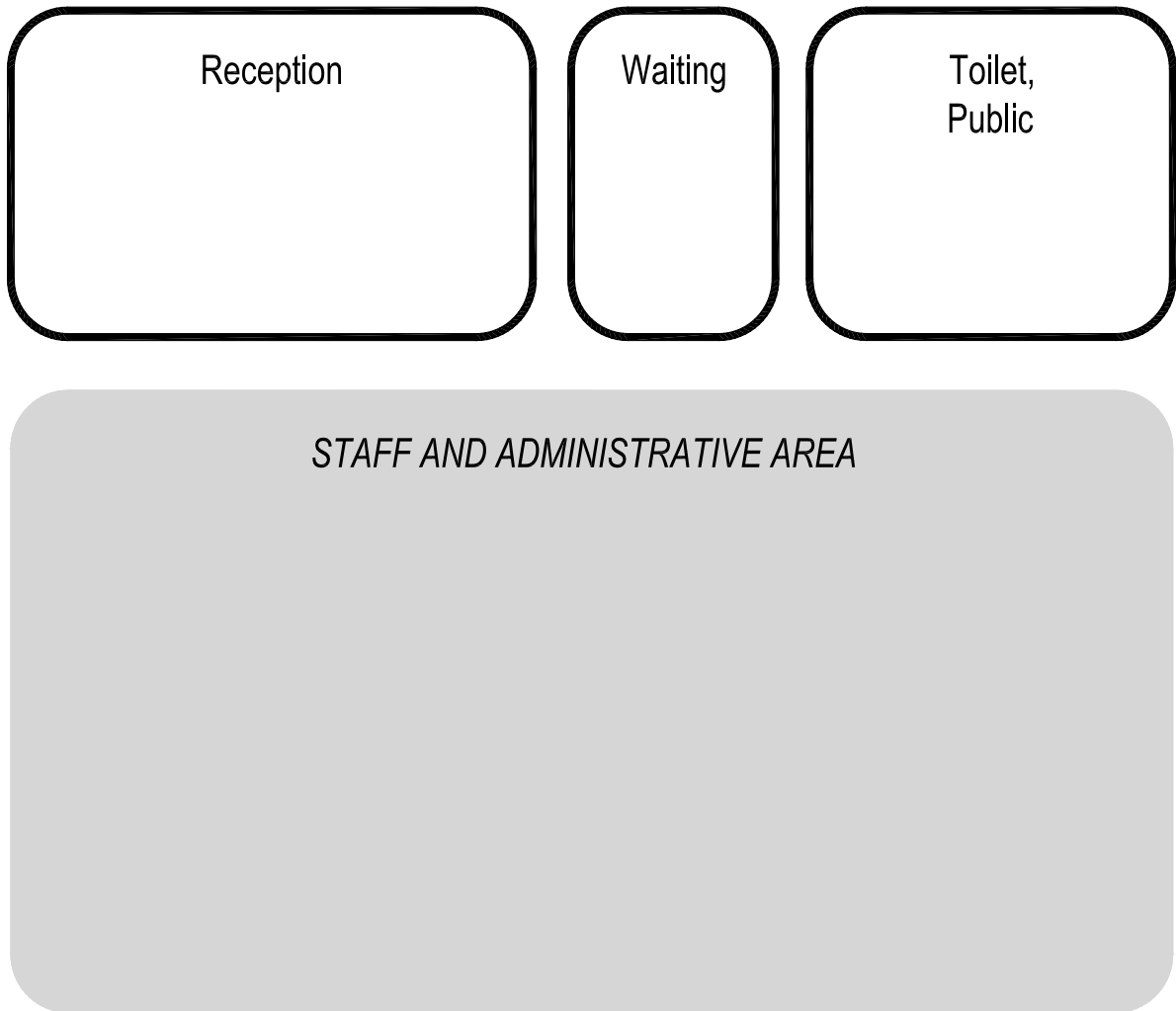

Functional Area Diagram

Computer Area

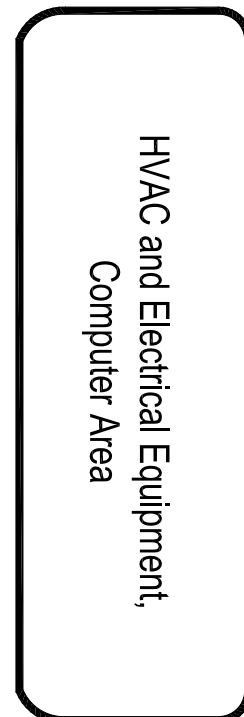
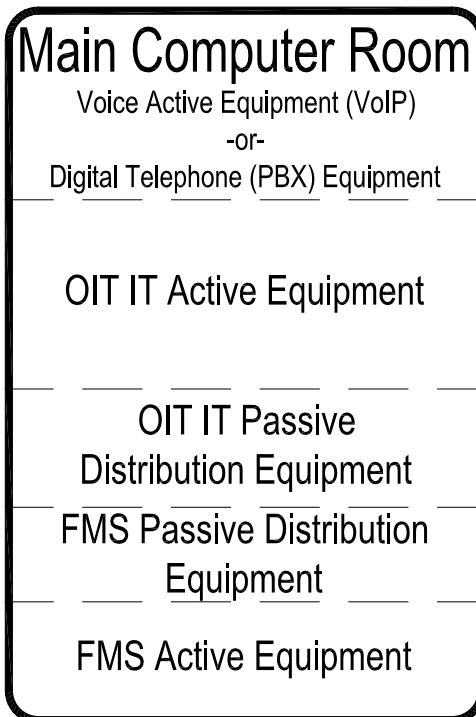
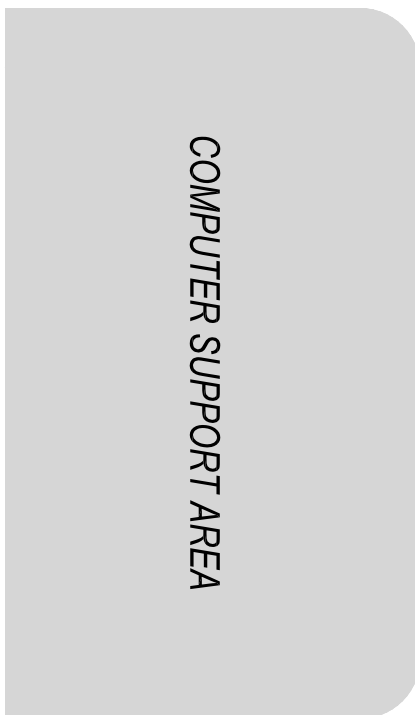
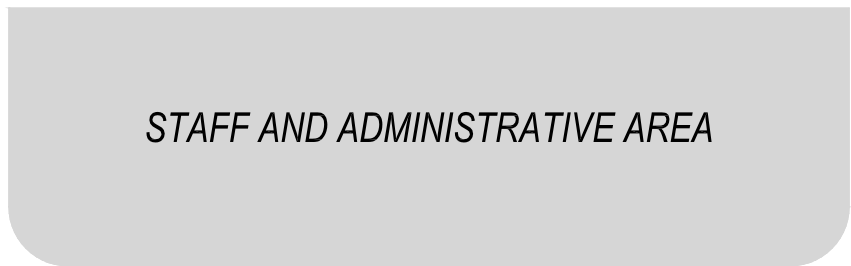
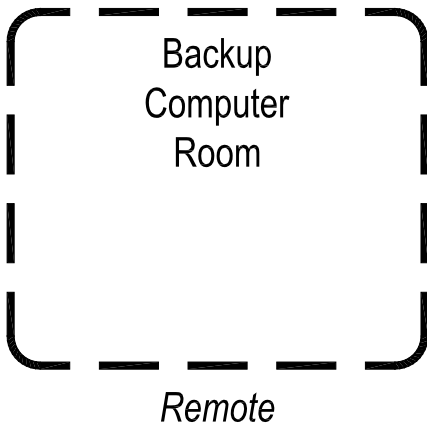

Functional Area Diagram

Computer Support Area

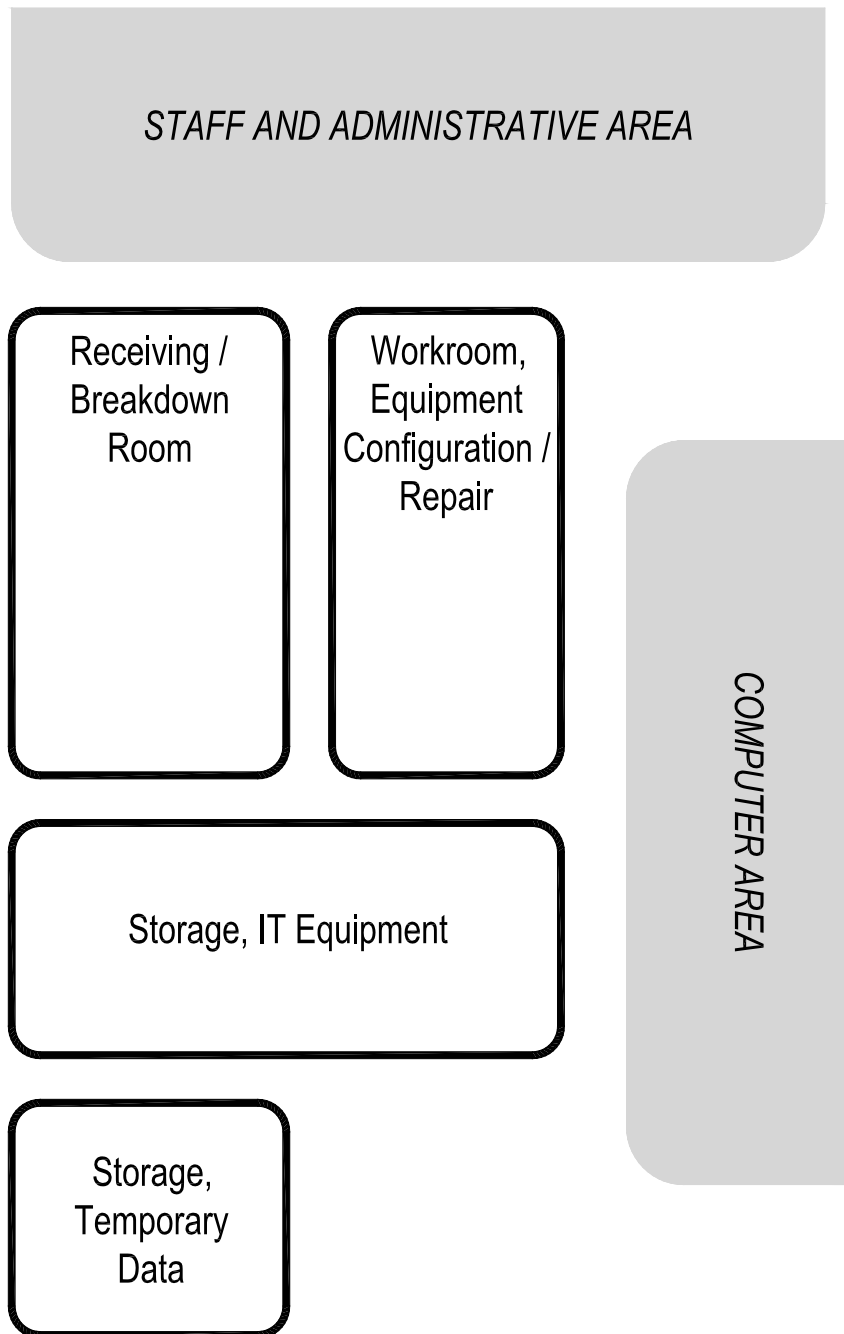

Functional Area Diagram

Telecommunications Support Area

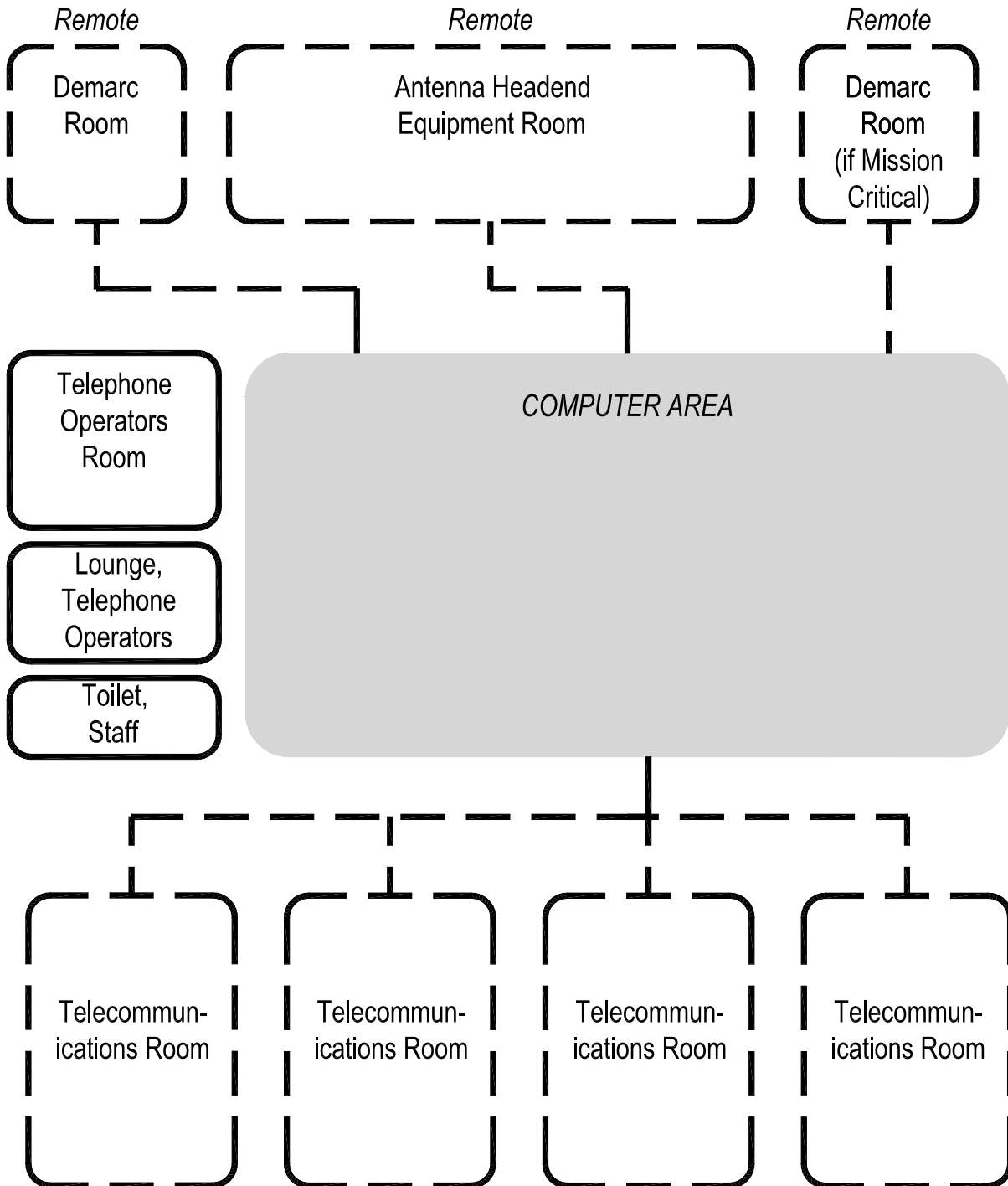

Quantity of Telecommunications Rooms as required

Functional Area Diagram

Staff and Administrative Area

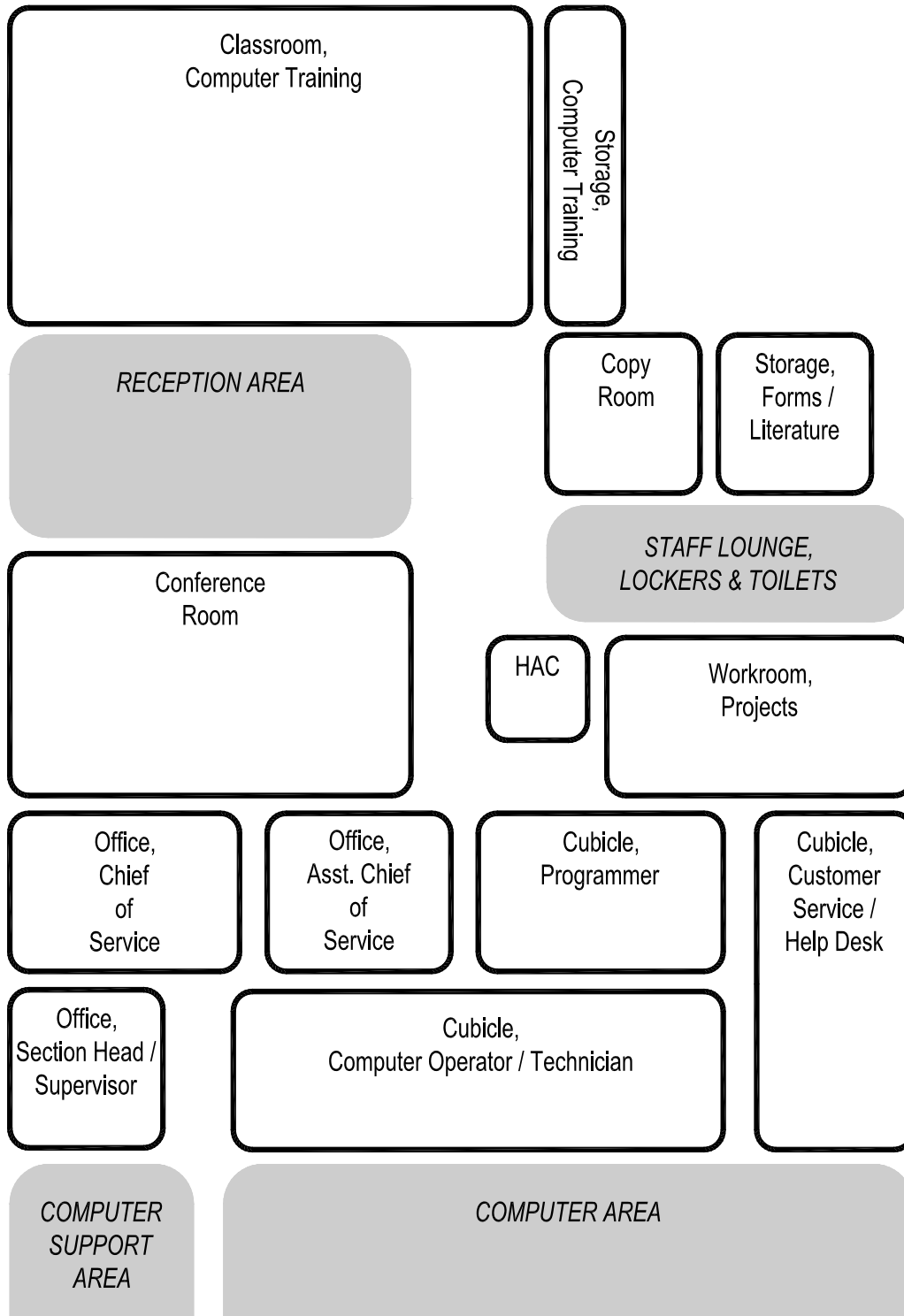

Functional Area Diagram

Staff Lounge, Lockers and Toilets

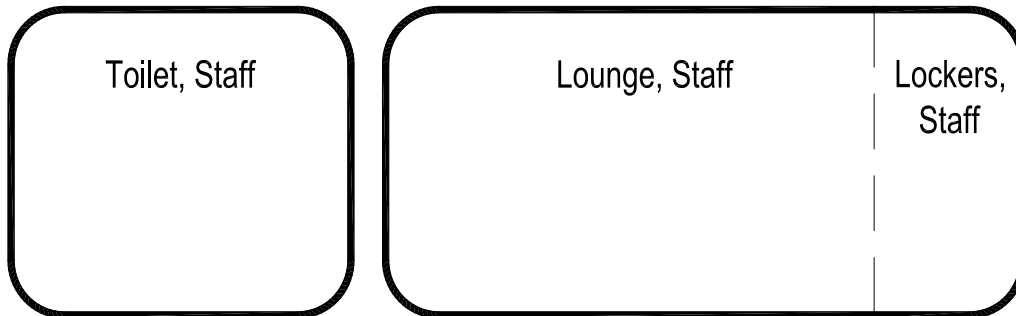

Functional Relationships Matrix

The following diagram presents the proximity relationships of OIT to various functional areas or spaces in a matrix format. Departments, functional areas, or spaces not included in the matrix have a neutral relationship or no relationship with OIT.

OIT provides IT hardware, software, and network support to all other Services at a medical center or other VA facility. The physical limitations for cabling runs in the network distribution or backbone will require TRs for OIT to be located in proximity to the using Services throughout the building or buildings served. Therefore the principal connection between OIT and other Services will be via the network, with little need for strong physical adjacencies. On the other hand, separation from some Services and other building systems is desirable or necessary for efficiency, security, and reliability.

Proximity Codes for Matrix

The degree of optimal proximity to other departments or areas that share a functional relationship with OIT is indicated by a scale of 1 to 4 (1 representing the greatest level of adjacency). An "X" entered in the diagram indicates that separation from the departments or areas in question is preferable.

Code	Proximity Relationship
1	Very Strong: Adjacent
2	Strong: Close, same floor
3	Moderate: Convenient, different floor acceptable
4	Weak: May be separated; limited traffic or communication necessary
-	Neutral or no relationship
X	Separation required or preferable

Table 3.1 Functional Relationships for OIT

Service	OIT Functional Areas				
	Computer	Computer Support	Telecom. Support	Reception & Admin.	Staff LLTS
Ambulatory Care (hospital based)	X	X	--	X	X
AMMS (dock and receiving)	X	X	X	X	X
Clinical Services Administration	--	--	--	4	4
Community Living Center (located at medical center)	X	X	--	X	X
Day Hospital / Day Treatment	X	X	X	X	X
Digestive Diseases	X	X	X	--	--
Electroencephalography Laboratory	X	X	X	X	X
EMS Administration	--	--	--	--	--
EMS Laundry	X	X	X	X	X
EMS LLTS	X	X	--	--	3
Engineering (Electrical Equipment Rooms - EMI sources)	X	X	X	X	X
Engineering (Mechanical Equipment Rooms - EMI sources)	X	X	X	X	X
Engineering (Energy Center – EMI sources)	X	X	X	X	X
Facilities Management Service (Engineering) (Admin and Shops)	X	--	--	4	4
Health Administration Service	--	--	--	4	4
Human Resources Mgmt	--	--	--	4	4
Intensive Care Nursing Units	X	X	--	--	--
Interventional Radiology	X	X	X	--	--
Magnetic Resonance Imaging	X	X	X	--	--
Medical Center Director Suite	--	--	--	4	4
MS&N Patient Care Units	X	X	--	X	X
Nuclear Medicine (EMI sources)	X	X	X	--	--
Nursing Service Administration	--	--	--	4	4
Nutrition and Food Service	X	X	--	--	--
Pathology & Lab Medicine	X	X	--	--	--
Radiology (EMI sources)	X	X	X	--	--
Research and Development (EMI sources)	X	X	X	--	--
Substance Abuse Clinic	X	X	X	X	X
Supply Processing and Distribution	X	X	--	--	--
Surgery	X	X	X	--	--
Veterans Canteen Service	X	X	--	--	--

Section 4

Design Guide Plates, Design Standards, and Equipment Lists

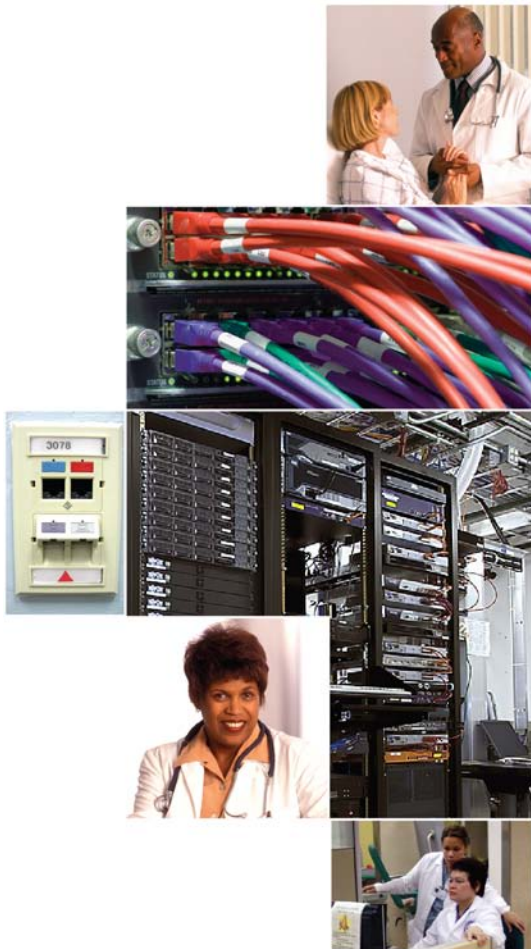

Page

Introduction..... 4-1

Equipment Modules..... 4-2

Guide Plates

This Table of Contents is organized by Functional Area (FA) and then by room name. See Appendix in Section 5 for Index of Guide Plates by room designations (SEPS code) used in the Space Planning Criteria.

Guide Plates have not been provided for offices, toilets, lockers, general storage, and other common spaces. Therefore, there are no Guide Plates for Functional Areas 1 and 6.

FA 2 Computer Area:

Backup Computer Room (ITBU1)..... 4-4

Key Plan, Computer Area..... 4-8

HVAC and Electrical Equipment, Computer Area (ITAC1) 4-10

Main Computer Room

VoIP Active Equipment (TEIP1)..... 4-14

Digital Telephone (PBX) Equipment (TEDP1) 4-20

OIT IT Active Equipment (ITAE1). 4-26

OIT IT Passive Distribution Equipment (ITPE1)..... 4-32

FMS Passive Distribution Equipment (FMPE1)..... 4-38

FMS Active Equipment (FMAE1) 4-44

Telephone Equipment Room..... 4-50

Network Operations Room (ITNT1)..... 4-54

Storage, Active Data (ITAD1) 4-58

FA 3 Computer Support Area:

Receiving / Breakdown Room (ITBD1).....4-62
Workroom, Equipment
Configuration / Repair (ITWR1)4-66
Storage, Temporary Data (ITRD1)4-72

FA 4 Telecommunications Support Area:

Antenna Headend Equipment Room
(TEEQ1)4-76
Demarc Room (TEDR1)4-80
Telecommunications Room (TETR1)4-84
Telephone Operators Room (TEOR1).....4-92

FA 5 Staff and Administrative Area:

Classroom, Computer Training (CLR03) ..4-98
Workroom, Projects (WRCH1)4-104

Introduction

The Design Guide Plates included with this publication are intended as general representations of typical furniture, equipment, and functional and personnel space needs. The Design Guide Plates were developed as a design tool to assist the Project Team in understanding the choices to be made during design, and to assist designers in understanding VA's functional requirements for OIT. The Guide Plates are not intended to be project specific and are not meant to limit design opportunities.

While plates are provided for a majority of spaces required, it is not possible to foresee all possible variations or future requirements. The project-specific space program shall be used as the basis for individual project design.

In all cases the Guide Plates must be reviewed against project criteria and any special requirements. Users shall refer to other VA criteria and standards (listed in Section 2) when information is either too detailed or too broad to be included in the Design Guide Plates. Equipment requirements and technologies are continually evolving. Equipment manufacturers shall be consulted for actual dimensions and utility requirements.

Equipment Modules

Typical Sizes and Clearances

Systems racks are open (non-enclosed) standardized frames for mounting multiple information technology or electronic equipment modules. Systems cabinets are protected enclosures containing a standardized frame for mounting multiple information technology or electronic equipment modules. Racks and cabinets are designed to accommodate equipment modules of standard widths and heights. Standard widths are nominal 19-inch (the most common) or 23-inch. The heights of standard modules are multiples of 1.75-inches (this dimension is known as one "Rack Unit" or "U").

Actual dimensions may vary by manufacturer, particularly for cabinets. Working clearances must be added to the physical dimension of the rack or cabinet to allow for installation or removal of equipment, door or access panel swings, cabling clearances, and technician access. To provide a uniform module for layout of the Guide Plates, the following dimensions were used. They are based on the largest racks or cabinets generally used by VA OIT.

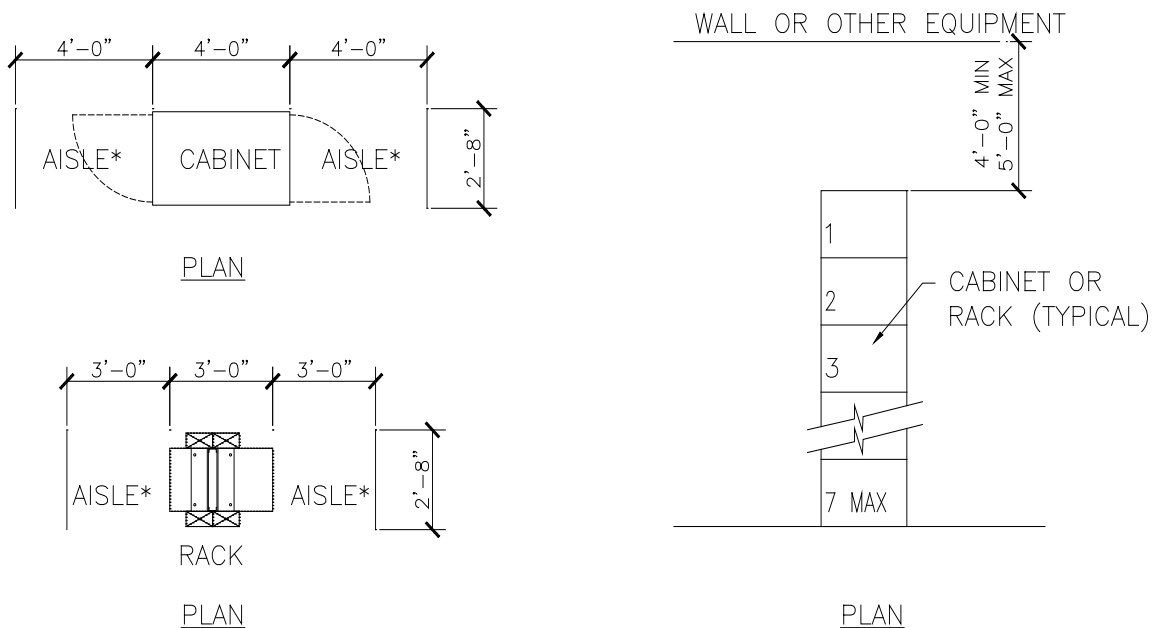

FRONT/REAR CLEARANCES
MAY OVERLAP CLEARANCES WITH
ADJACENT EQUIPMENT ROW(S)

END CLEARANCES
REQUIRED ON AT LEAST ONE END OF
EACH ROW OF CABINETS OR RACKS

Figure 4.1 IT Rack and Cabinet Modules

This page intentionally left blank

Backup Computer Room (ITBU1)

425 NSF*

Floor Plan

39.5 NSM

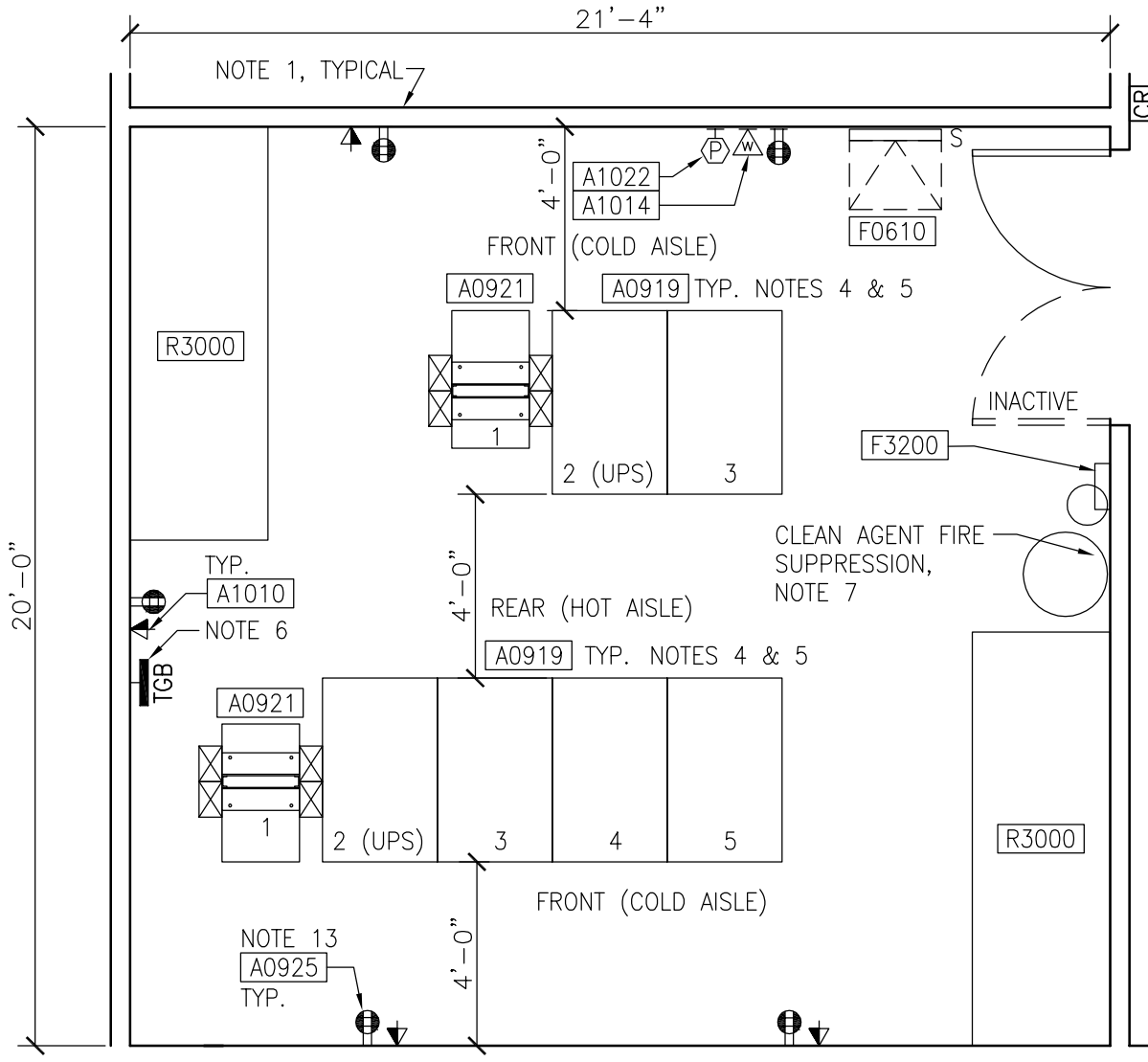

* MINIMUM ROOM SIZE IS 300 NSF. ROOM SHOWN IS BASED ON A FACILITY SIZE OF 300,000 NSF.

SEE DESIGN STANDARDS PAGE OF THIS GUIDE PLATE FOR NUMBERED NOTES.

SEE SECTION 1 FOR SYMBOL LEGEND.

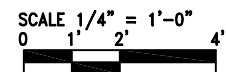

Note: Guide plates are graphical representations of selected room types, illustrating the integration of space, building systems (lights, HVAC, etc), and telecommunications equipment. The Design Team is responsible to perform the calculations to determine final quantities as well as location of each component for every project. Specific infrastructure design requirements are contained in PG 18-5: Equipment Guide List, PG 18-9: Space Planning Criteria, and PG 18-10: Design Manuals (by discipline) located in the VA's Technical Information Library (TIL) <http://www.cfm.va.gov/TIL/>.

Backup Computer Room (ITBU1)
 Reflected Ceiling Plan

425 NSF*
 39.5 NSM

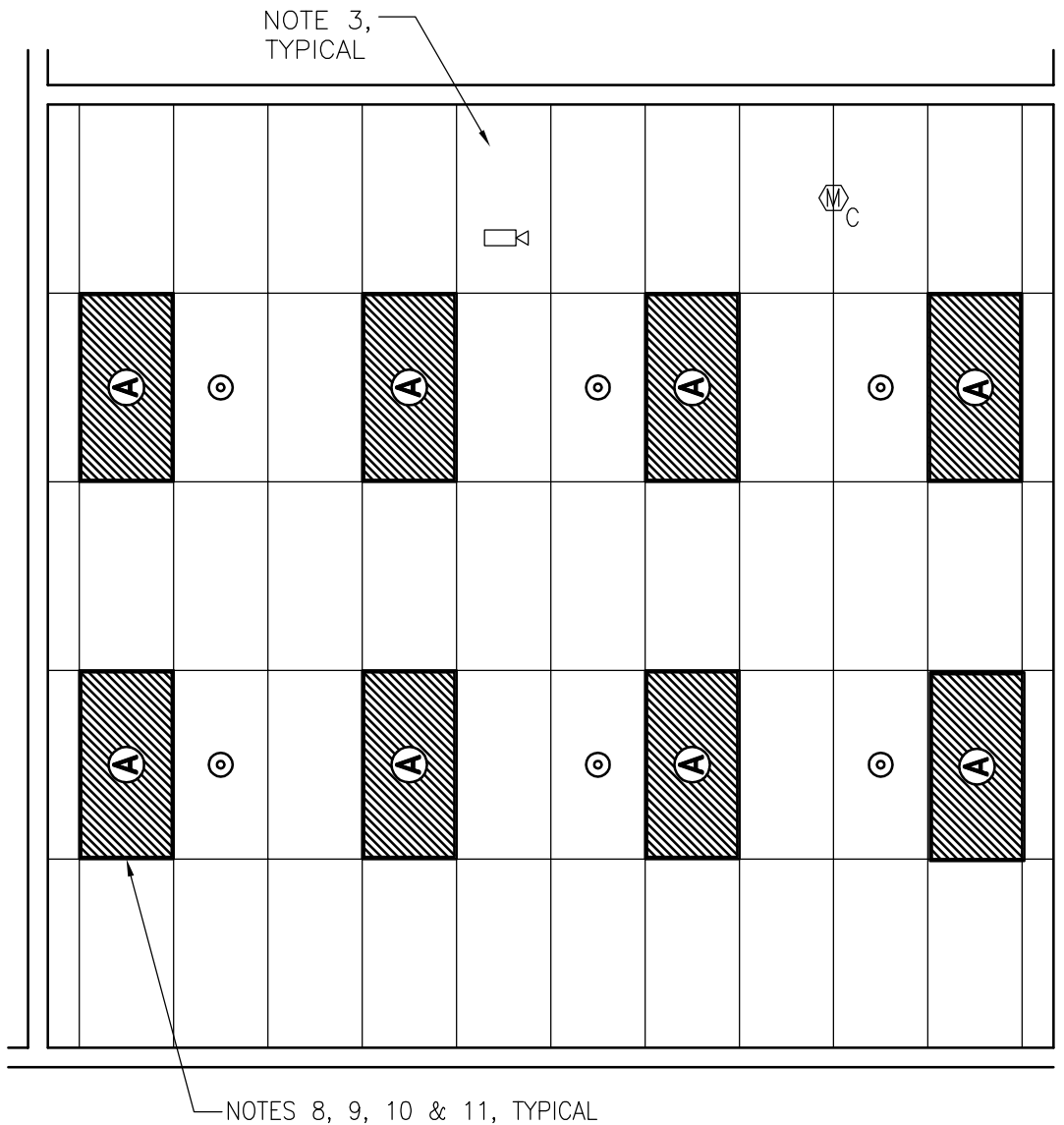

* MINIMUM ROOM SIZE IS 300 NSF. ROOM SHOWN IS BASED ON A FACILITY SIZE OF 300,000 NSF.

SEE DESIGN STANDARDS PAGE OF THIS GUIDE PLATE FOR NUMBERED NOTES.

SEE SECTION 1 FOR SYMBOL LEGEND.

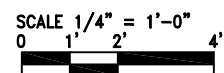

Note: Guide plates are graphical representations of selected room types, illustrating the integration of space, building systems (lights, HVAC, etc), and telecommunications equipment. The design Team is responsible to perform the calculations to determine final quantities as well as location of each component for every project. Specific infrastructure design requirements are contained in PG 18-5: Equipment Guide List, PG 18-9: Space Planning Criteria and PG 18-10: Design Manuals (by discipline) located in the VA's Technical Information Library (TIL) <http://www.cfm.va.gov/TIL/>.

Backup Computer Room (ITBU1)

Design Standards

ARCHITECTURAL

Ceiling:	Note 3
Ceiling Height:	9'-0"
Wall Finish:	GWB-P; Note 1
Wainscot:	--
Base:	RB
Floor Finish:	Note 2
Slab Depression:	24"
Sound Protection:	STC 40
Doors:	Pair, Size SS (36"W x 84"H each leaf)

Notes:

- 1) Partitions and openings to comply with VA PSDM.
- 2) Access floor.
- 3) Clean Room acoustical ceiling panels.

SPECIAL EQUIPMENT

Notes:

- 4) Racks and cabinets are CC. See Equipment List. See *Equipment Modules* page 4-2 for typical rack and cabinet dimensions and clearances,
- 5) Systems are VV.
- 6) Provide Telecommunications Bonding Backbone (EDM 8.3), and conduit connectivity (EDM Table 7-1).
- 7) Provide clean agent fire suppression in room and above ceiling. Clean agent fire suppression heads are not shown.

LIGHTING

General: Refer to Electrical Design Manual.

Special: --

Notes:

- 8) All lighting shall be connected to the Critical Branch of the ESS (EDM 4.6).
- 9) 50 average maintained fc illumination level.
- 10) Recessed three-lamp fluorescent lighting fixture with F32T8 lamps, 3500°K, CRI=70 (minimum).
- 11) Exact quantity, location, and lamping of fixtures shall be chosen to meet the footcandle requirement.

POWER

General: Refer to Electrical Design Manual.

Emergency: Refer to Electrical Design Manual.

Notes:

- 12) Refer to Technical Considerations in Section 2 of this Design Guide.
- 13) All receptacles and equipment shall be connected to UPS power (EDM 5.3), and the UPS equipment connected to the Critical Branch of the ESS (EDM 4.6).

COMMUNICATION/SPECIAL SYSTEMS

Data:	Yes
Telephone:	Yes
Cable Television:	--
Duress Alarm:	Yes
Electronic Access and Door Control:	Yes
Intercom:	--
Motion Intrusion Detection (MID):	Yes
Nurse Call, Code One (Blue):	--
Public Address:	--
Security Surveillance Television (SSTV)	Yes
VA Satellite TV:	--
Video Teleconferencing (VTEL):	--
Notes:	--

HEATING, VENTILATING AND AIR CONDITIONING

Inside Design Conditions:

Indoor design temperature shall be 64-75 degrees F, with relative humidity between 30% and 55%.

Notes:

- 14) Refer to Technical Considerations in Section 2 of this Design Guide.

PLUMBING AND MEDICAL GASES

Cold Water:	--
Hot Water:	--
Laboratory Air:	--
Laboratory Vacuum:	--
Sanitary Drain:	--
Reagent Grade Water:	--
Medical Air:	--
Medical Vacuum:	--
Oxygen:	--
Notes:	--

- 15) Do not run pipe containing liquids (such as water, drain, or steam) above this space; except as required to provide fire suppression for this space only.



Backup Computer Room (ITBU1)

Equipment Guide List

JSN	NAME	QTY	AI	DESCRIPTION	SPEC
A0926	Tray, Cable, for Communications Systems	AR	CC	Cable trays for communications systems.	26 05 36
A0919	Cabinet, With Internal Equipment Mounting Rack, Steel	AR	CC	Cabinet with internal equipment mounting rack, steel.	27 11 00
A0921	Rack, Equipment, Freestanding, Steel	AR	CC	Equipment rack, freestanding, steel.	27 31 00
A0923	Wire Management System	AR	CC	Wire management system.	27 31 00
A0920	Cross-Connection System (CCS)	AR	CC	Equipment breakout, Termination Connector, (or Bulkhead), and Patch Panels	27 11 00
A0922	Voice Communications Switching and Routing Equipment	AR	CC	Voice Communications Switching and Routing Equipment	27 31 00
A1010	Telecommunication Outlet	4	CC	Telecommunication outlet location.	27 15 00
A1014	Telephone, Wall Mounted, 1 Line, With Speaker	1	VV	Telephone, wall mounted, 1 line, with speaker.	
F0610	Desk Folding, W/M	1	CC	Wall mounted fold down desk, approximately 18" H x 23" W x 3" D, with writing surface, pencil-pen rack and multiple form holders.	12 31 00 Or 12 32 00
F3200	Clock, Battery, 12" Diameter	1	VV	Round surface, easy to read numbers with sweep second hand. Wall mounted unit for use when impractical to install a fully synchronized clock system. Battery operated, (batteries not included).	
R3000	Air Conditioner, Computer Room	AR	CC	Process cooling, split system or chilled water, air conditioning unit(s) designed for computer room use. Unit(s) shall be packaged, factory assembled, prewired, and pre-piped; consisting of cabinet, fans, filters, humidifier, and controls.	23 81 23
A0925	Receptacle, Electrical, Quadraplex	5	CC	Receptacle, quadraplex, 120 V.	26 27 26
A1022	Button, Alarm, Security/Duress	1	CC	Alarm button, Security/Duress.	27 52 31
				End of Equipment List	



This page intentionally left blank.

Key Plan

Computer Area

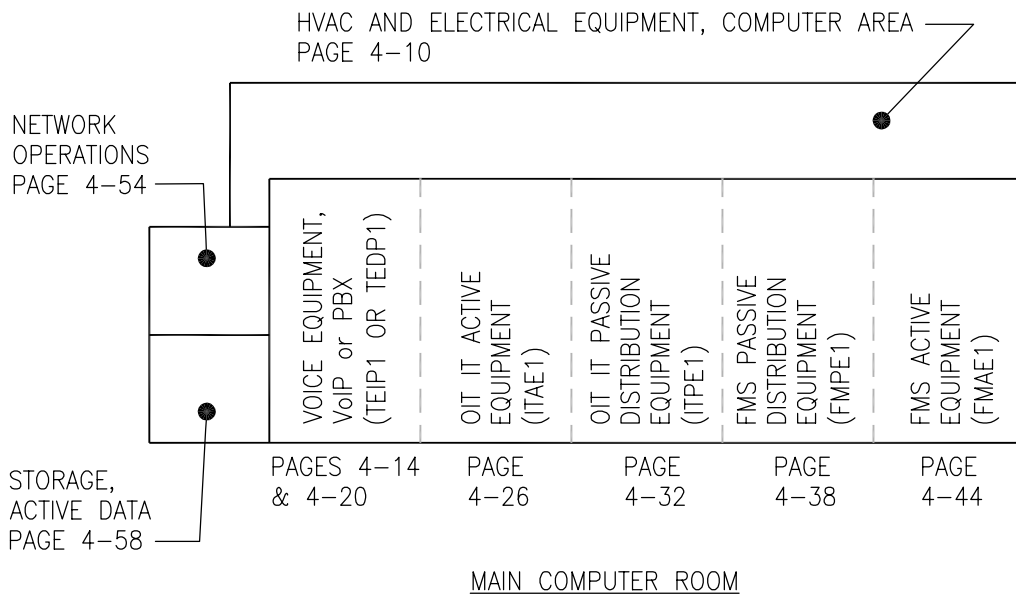

GUIDE PLATES FOR MAIN COMPUTER ROOM AND HVAC AND ELECTRICAL EQUIPMENT, COMPUTER AREA ARE FOR A TYPICAL FACILITY AS SHOWN ON THE FOLLOWING PAGES. PROJECT TEAM SHALL ADJUST AS NECESSARY. ACTUAL FACILITY REQUIREMENTS SHALL BE IN ACCORDANCE WITH SPACE CRITERIA CHAPTER 232.

SEE DESIGN STANDARDS PAGE OF THIS GUIDE PLATE FOR NUMBERED NOTES.

SEE SECTION 1 FOR SYMBOL LEGEND.

Note: Guide plates are graphical representations of selected room types, illustrating the integration of space, building systems (lights, HVAC, etc), and telecommunications equipment. The Design Team is responsible to perform the calculations to determine final quantities as well as location of each component for every project. Specific infrastructure design requirements are contained in PG 18-5: Equipment Guide List, PG 18-9: Space Planning Criteria, and PG 18-10: Design Manuals (by discipline) located in the VA's Technical Information Library (TIL) <http://www.cfm.va.gov/TIL/>.

HVAC and Electrical Eq., Computer Area (ITAC1)

510 NSF*

Floor Plan

47.4 NSM

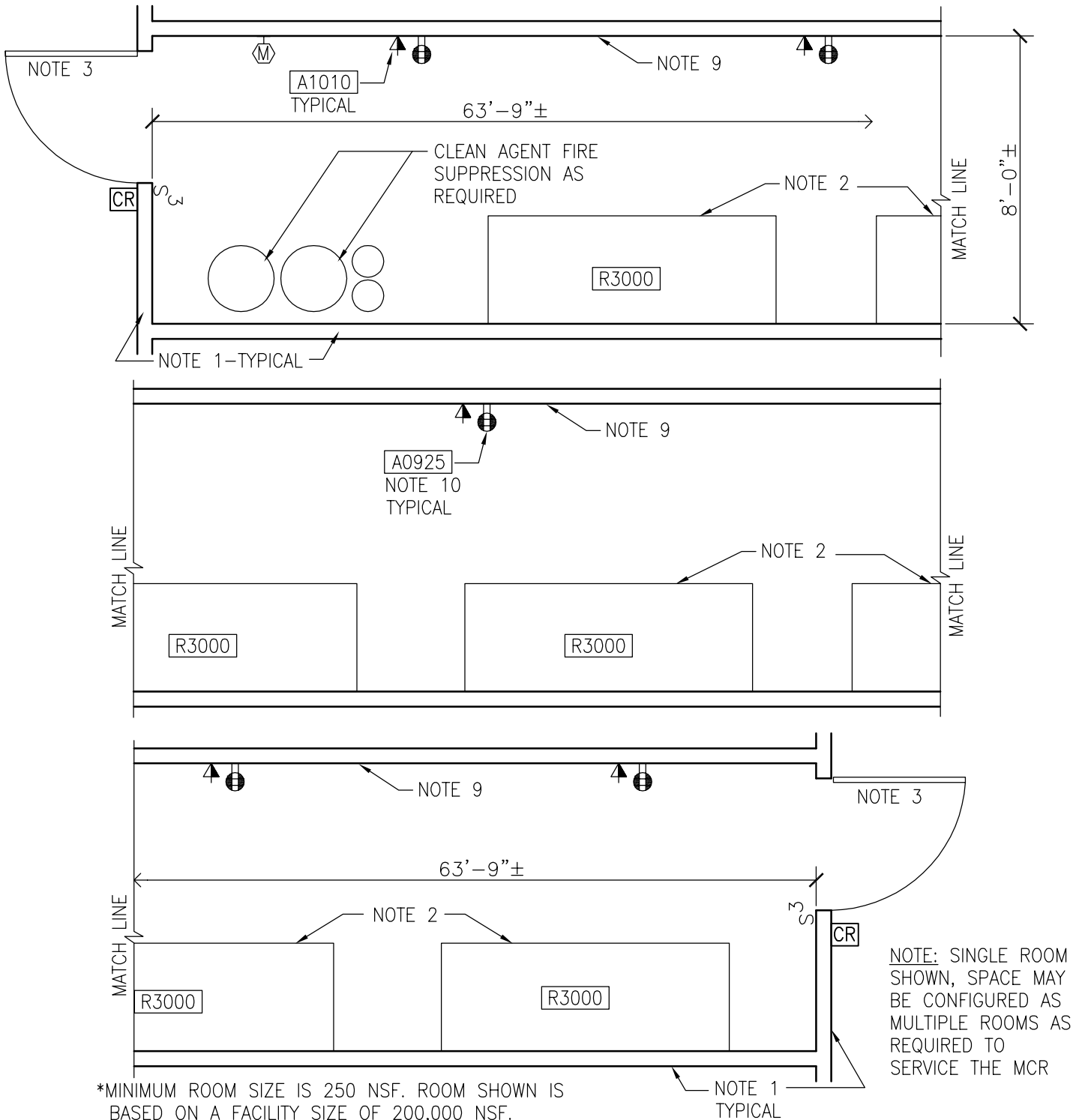

*MINIMUM ROOM SIZE IS 250 NSF. ROOM SHOWN IS BASED ON A FACILITY SIZE OF 200,000 NSF.

SEE DESIGN STANDARDS PAGE OF THIS GUIDE PLATE FOR NUMBERED NOTES.

SEE SECTION 1 FOR SYMBOL LEGEND.

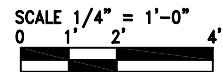

Note: Guide plates are graphical representations of selected room types, illustrating the integration of space, building systems (lights, HVAC, etc), and telecommunications equipment. The Design Team is responsible to perform the calculations to determine final quantities as well as location of each component for every project. Specific infrastructure design requirements are contained in PG 18-5: Equipment Guide List, PG 18-9: Space Planning Criteria, and PG 18-10: Design Manuals (by discipline) located in the VA's Technical Information Library (TIL) <http://www.cfm.va.gov/TIL/>.

HVAC and Electrical Eq., Computer Area (ITAC1)

510 NSF*

Reflected Ceiling Plan

47.4 NSM

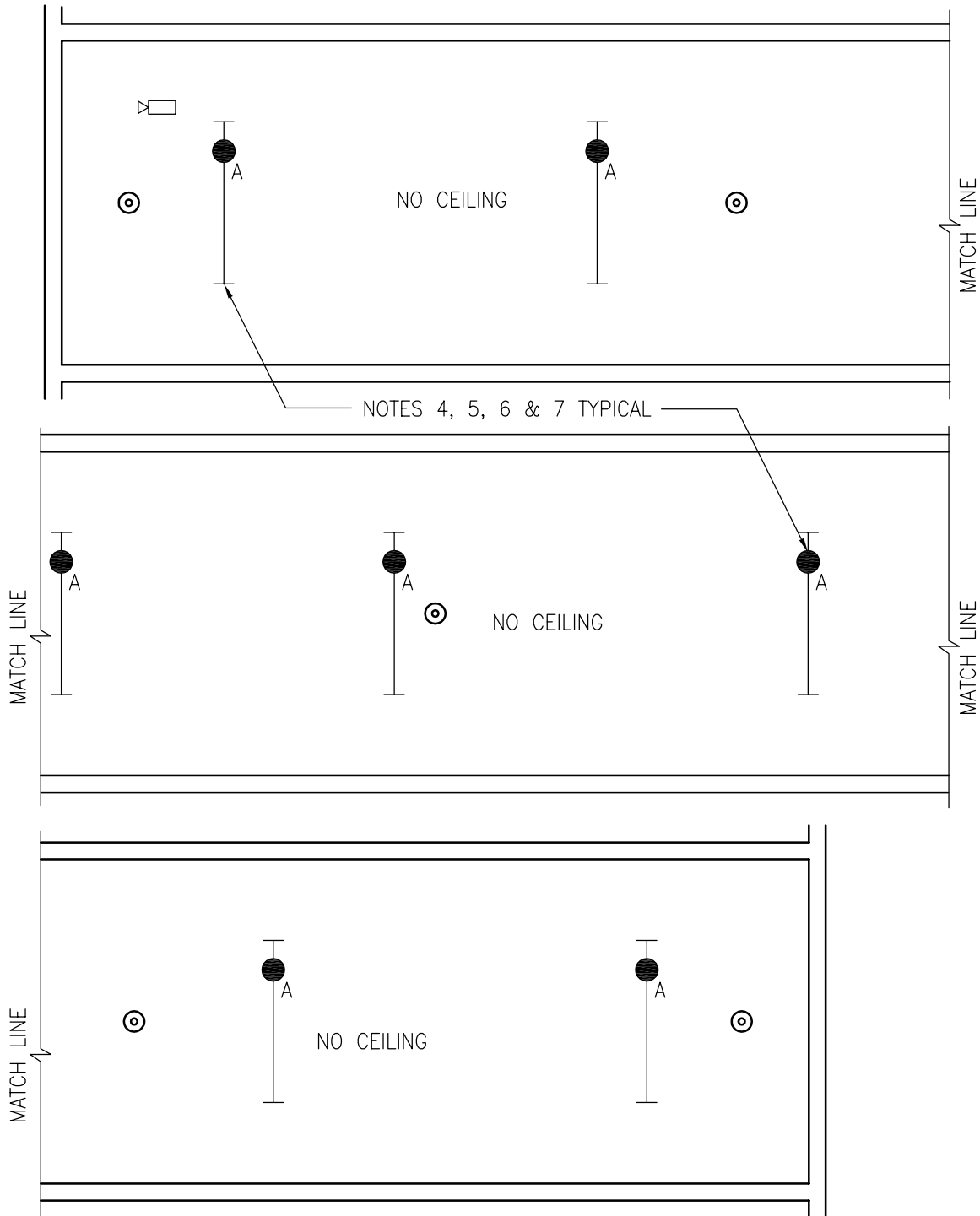

*MINIMUM ROOM SIZE IS 250 NSF. ROOM SHOWN IS BASED ON A FACILITY SIZE OF 200,000 NSF.
 SEE DESIGN STANDARDS PAGE OF THIS GUIDE PLATE FOR NUMBERED NOTES.

SEE SECTION 1 FOR SYMBOL LEGEND.

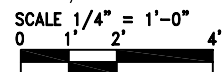

Note: Guide plates are graphical representations of selected room types, illustrating the integration of space, building systems (lights, HVAC, etc), and telecommunications equipment. The Design Team is responsible to perform the calculations to determine final quantities as well as location of each component for every project. Specific infrastructure design requirements are contained in PG 18-5: Equipment Guide List, PG 18-9: Space Planning Criteria, and PG 18-10: Design Manuals (by discipline) located in the VA's Technical Information Library (TIL)
<http://www.cfm.va.gov/TIL/>.

HVAC and Electrical Equipment, Computer Area (ITAC1)

Design Standards

ARCHITECTURAL

Ceiling:	EXP
Ceiling Height:	--
Wall Finish:	GWB-P; Note 1
Wainscot:	--
Base:	RB
Floor Finish:	RES-1
Slab Depression:	Note 2
Sound Protection:	STC 45
Doors:	Note 3

Notes:

- 1) Partitions and openings to comply with VA PSDM.
- 2) Depress floor areas or provide chases as required for distribution of services to access floor in Main Computer Room.
- 3) Doors-Type 19/20, Size V (44"W x 84"H) –OR- pair Size SS (each leaf 36"W x 84"H); with sound seals.

SPECIAL EQUIPMENT

Notes: --

LIGHTING

General: Refer to Electrical Design Manual.

Special: --

Notes:

- 4) All lighting shall be connected to the Critical Branch of the ESS (EDM 4.6).
- 5) 30 average maintained fc illumination level.
- 6) Suspended three-lamp fluorescent strip lighting fixture with wireguard and F32T8 lamps, 3500°K, CRI=70 (minimum).
- 7) Exact quantity, location, and lamping of fixtures shall be chosen to meet the footcandle requirement.

POWER

General: Refer to Electrical Design Manual.

Emergency: Refer to Electrical Design Manual.

Notes:

- 8) Refer to Technical Considerations in Section 2 of this Design Guide.
- 9) Space reserved for electrical panelboards and equipment that serve the MCR CRACs, MCR UPS equipment, and MCR general power.
- 10) All receptacles and equipment shall be connected to the Equipment Branch of the ESS (EDM 4.6).

COMMUNICATION/SPECIAL SYSTEMS

Data:	Yes
Telephone:	Yes
Cable Television:	--
Duress Alarm:	--
Electronic Access and Door Control:	Yes
Intercom:	--
Motion Intrusion Detection (MID):	Yes
Nurse Call, Code One (Blue):	--
Public Address:	--
Security Surveillance Television (SSTV):	Yes
VA Satellite TV:	--
Video Conferencing (VTEL):	--
Notes:	--

HEATING, VENTILATING AND AIR CONDITIONING

Inside Design Conditions:

Refer to HVAC Design Manual.

Notes:

- 11) Computer Room Air Conditioning units shall serve only the Main Computer Room and associated support spaces within the Computer Area in accordance with NFPA 75.
- 12) Refer to Technical Considerations in Section 2 of this Design Guide.

PLUMBING AND MEDICAL GASES

Cold Water:	--
Hot Water:	--
Laboratory Air:	--
Laboratory Vacuum:	--
Sanitary Drain:	--
Reagent Grade Water:	--
Medical Air:	--
Medical Vacuum:	--
Oxygen:	--
Notes:	--

HVAC and Electrical Equipment, Computer Area (ITAC1)

Equipment Guide List

JSN	NAME	QTY	AI	DESCRIPTION	SPEC
A1010	Telecommunication Outlet	AR	CC	Telecommunication outlet location.	27 15 00
R3000	Air Conditioner, Computer Room, Floor Mounted	AR	CC	Process cooling, split system or chilled water, air conditioning unit(s) designed for computer room use. Unit(s) shall be packaged, factory assembled, prewired, and pre-piped; consisting of cabinet, fans, filters, humidifier, and controls.	23 81 23
A0925	Receptacle, Electrical, Quadraplex	AR	CC	Receptacle, quadraplex, 120 V.	26 27 26
				End of Equipment List	

VoIP Active Equipment (TEIP1)

400 NSF*

Floor Plan

37.2 NSM

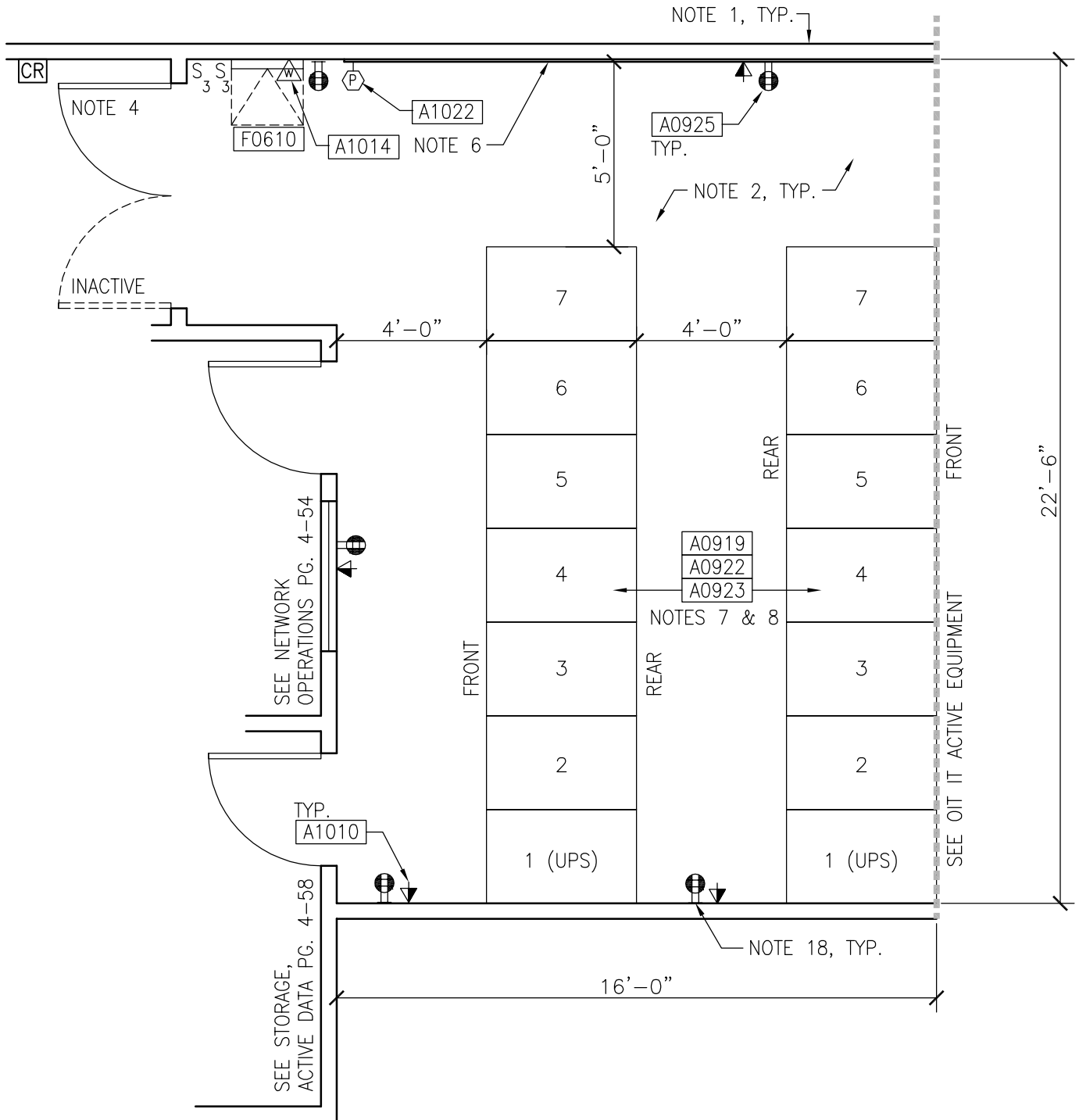

*MINIMUM ROOM SIZE IS 160 NSF. ROOM SHOWN IS BASED ON A FACILITY SIZE OF 300,000 NSF, AND HAS BEEN NORMALIZED TO MATCH ADJACENT SPACE.

SEE DESIGN STANDARDS PAGE OF THIS GUIDE PLATE FOR NUMBERED NOTES.

SEE SECTION 1 FOR SYMBOL LEGEND.

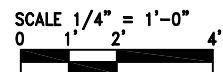

Note: Guide plates are graphical representations of selected room types, illustrating the integration of space, building systems (lights, HVAC, etc), and telecommunications equipment. The Design Team is responsible to perform the calculations to determine final quantities as well as location of each component for every project. Specific infrastructure design requirements are contained in PG 18-5: Equipment Guide List, PG 18-9: Space Planning Criteria, and PG 18-10: Design Manuals (by discipline) located in the VA's Technical Information Library (TIL) <http://www.cfm.va.gov/TIL/>.

VoIP Active Equipment (TEIP1)

400 NSF*

Reflected Ceiling Plan

37.2 NSM

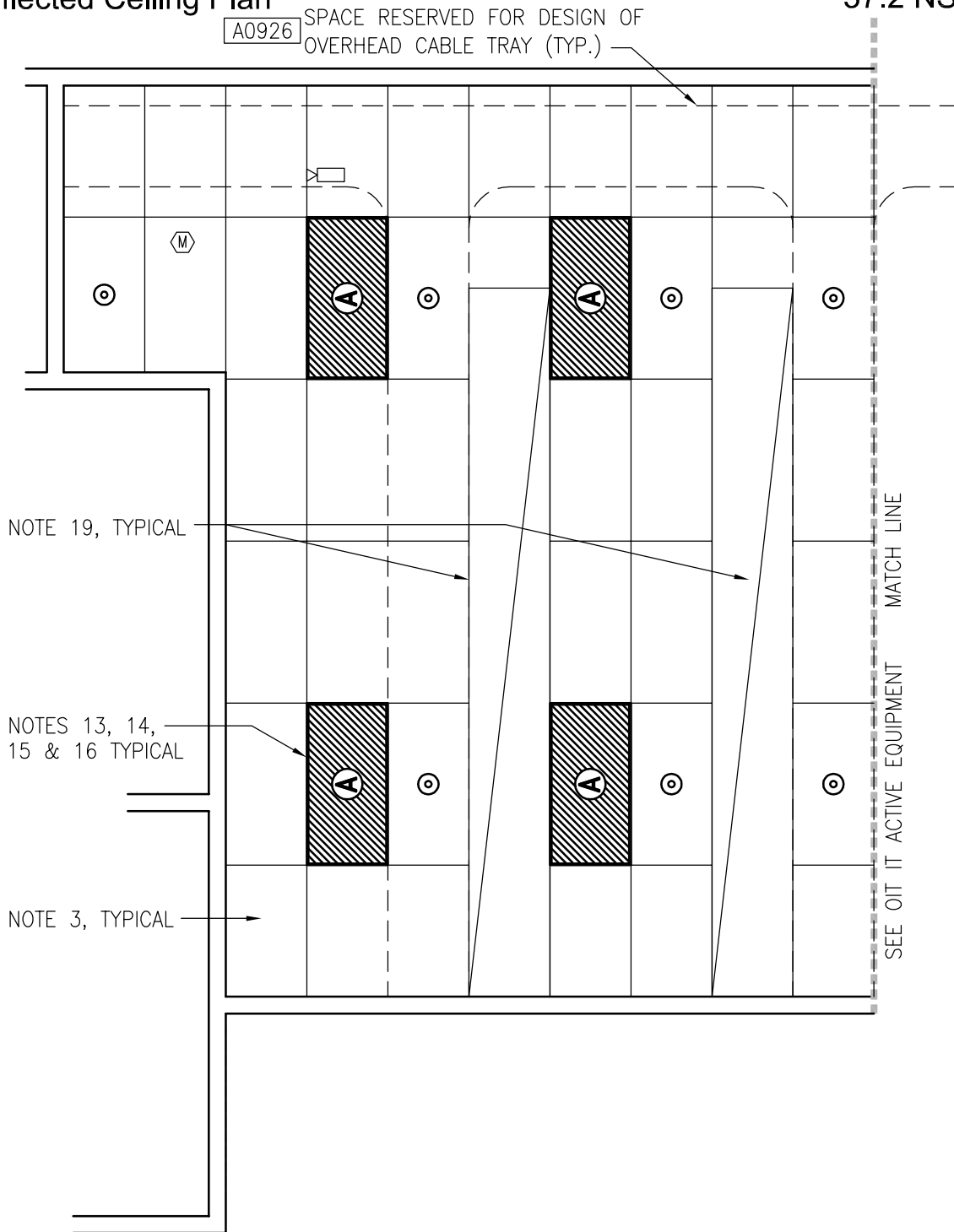

*MINIMUM ROOM SIZE IS 160 NSF. ROOM SHOWN IS BASED ON A FACILITY SIZE OF 300,000 NSF, AND HAS BEEN NORMALIZED TO MATCH ADJACENT SPACE.

SEE DESIGN STANDARDS PAGE OF THIS GUIDE PLATE FOR NUMBERED NOTES.

SEE SECTION 1 FOR SYMBOL LEGEND.

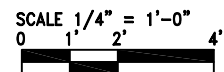

Note: Guide plates are graphical representations of selected room types, illustrating the integration of space, building systems (lights, HVAC, etc), and telecommunications equipment. The Design Team is responsible to perform the calculations to determine final quantities as well as location of each component for every project. Specific infrastructure design requirements are contained in PG 18-5: Equipment Guide List, PG 18-9: Space Planning Criteria, and PG 18-10: Design Manuals (by discipline) located in the VA's Technical Information Library (TIL) <http://www.cfm.va.gov/TIL/>.

VoIP Active Equipment (TEIP1)

Design Standards

ARCHITECTURAL

Ceiling / Ceiling Height:	Note 3
Wall Finish:	GWB-P; Notes 1 and 6
Wainscot:	--
Base:	RB
Floor Finish:	Note 2
Slab Depression:	24"
Sound Protection:	STC 40
Doors:	Note 4

Notes:

- 1) Partitions and openings to comply with VA PSDM.
- 2) Access floor.
- 3) Clean Room acoustical ceiling panels. Align ceiling grid with access floor panels. 10'-6" ceiling height (measured from top of access floor to underside of suspended grid) is required for cabling above equipment racks and cabinets.
- 4) Door Size: single S (36"W x 84"H); pair SS (36"W x 84"H each leaf). Each computer room shall have at least one set of paired doors for equipment access. All doors shall swing out from the MCR. Provide suitable alcoves to corridor(s).
- 5) Wire Mesh Partition from top of access floor to underside of suspended ceiling; MCS 10 22 13.
- 6) Painted ¾-inch fire retardant plywood over GWB where indicated. Area reserved (1 x 15 feet) for wall-mounted passive termination equipment for voice backbone cabling.

SPECIAL EQUIPMENT

Notes:

- 7) Racks and cabinets are CC. See Equipment List. See *Equipment Modules* page 4-2 for typical rack and cabinet dimensions and clearances,
- 8) Systems are VV.
- 9) Overhead conduits carrying OIT and FMS backbone cabling to TRs or Demarcs are not shown.
- 10) Provide Telecommunications Bonding Backbone (EDM 8.3), and conduit connectivity (EDM Table 7-1).

SPECIAL EQUIPMENT (continued)

- 11) Provide clean agent fire suppression in room, above ceiling, and under access floor. Clean agent fire suppression heads are not shown.
- 12) Provide moisture detection sensors under access floor.

LIGHTING

General: Refer to Electrical Design Manual

Notes:

- 13) All lighting shall be connected to the Critical Branch of the ESS (EDM 4.6).
- 14) 50 average maintained fc illumination level.
- 15) Recessed four-lamp fluorescent lighting fixture with acrylic lens and F32T8 lamps, 3500°K, CRI=70 (minimum).
- 16) Exact quantity, location, and lamping of fixtures shall be chosen to meet the footcandle requirement.

POWER

General: Refer to Electrical Design Manual

Emergency: Refer to Electrical Design Manual

Notes:

- 17) Refer to Technical Considerations in Section 2 of this Design Guide.
- 18) All receptacles and equipment shall be connected to UPS power (EDM 5.3), and the UPS equipment connected to the Critical Branch of the ESS (EDM 4.6).

COMMUNICATION/SPECIAL SYSTEMS

Data:	Yes
Telephone:	Yes
Cable Television:	--
Duress Alarm:	Yes
Electronic Access and Door Control:	Yes
Intercom:	--
Motion Intrusion Detection (MID):	Yes
Nurse Call, Code One (Blue):	--
Public Address:	--
Security Surveillance Television (SSTV)	Yes
VA Satellite TV:	--
Video Teleconferencing (VTEL):	--
Notes:	--

Continued on Next Page



VoIP Active Equipment (TEIP1)

Design Standards (continued)

HEATING, VENTILATING AND AIR CONDITIONING

Inside Design Conditions:

Indoor design temperature shall be 64-75 degrees F, with relative humidity between 30% and 55%.

Notes:

- 19) Hot aisle containment encloses and captures the hot IT exhaust, and ducts the hot air directly back to the air handling equipment in the HVAC and Equipment, Computer Area (ITAC1) room. Refer to Technical Considerations in Section 2 of this Design Guide.

PLUMBING AND MEDICAL GASES

Cold Water:	--
Hot Water:	--
Laboratory Air:	--
Laboratory Vacuum:	--
Sanitary Drain:	--
Reagent Grade Water:	--
Medical Air:	--
Medical Vacuum:	--
Oxygen:	--

Notes:

- 20) Do not run pipe containing liquids (such as water, drain, or steam) above this space; except as required to provide fire suppression for this space only.



VoIP Active Equipment (TEIP1)

Equipment Guide List

JSN	NAME	QTY	AI	DESCRIPTION	SPEC
A0926	Tray, Cable, for Communications Systems	AR	CC	Cable trays for communications systems.	26 05 36
A0919	Cabinet, With Internal Equipment Mounting Rack, Steel	AR	CC	Cabinet with internal equipment mounting rack, steel.	27 11 00
A0923	Wire Management System	AR	CC	Wire management system.	27 31 00
A0922	Voice Communications Switching and Routing Equipment	AR	CC	Voice Communications Switching and Routing Equipment	27 31 00
A1010	Telecommunication Outlet	AR	CC	Telecommunication outlet location.	27 15 00
A1014	Telephone, Wall Mounted, 1 Line, With Speaker	1	VV	Telephone, wall mounted, 1 line, with speaker.	
F0610	Desk Folding, W/M	1	CC	Wall mounted fold down desk, approximately 18" H x 23" W x 3" D, with writing surface, pencil-pen rack and multiple form holders.	12 31 00 Or 12 32 00
A0925	Receptacle, Electrical, Quadruplex	AR	CC	Receptacle, quadruplex, 120 V.	26 27 26
A1022	Button, Alarm, Security/Duress	AR	CC	Alarm button, Security/Duress.	27 52 31
				End of Equipment List	



This page intentionally left blank.

Digital Telephone (PBX) Equipment (TEDP1)

400 NSF*

Floor Plan

37.2 NSM

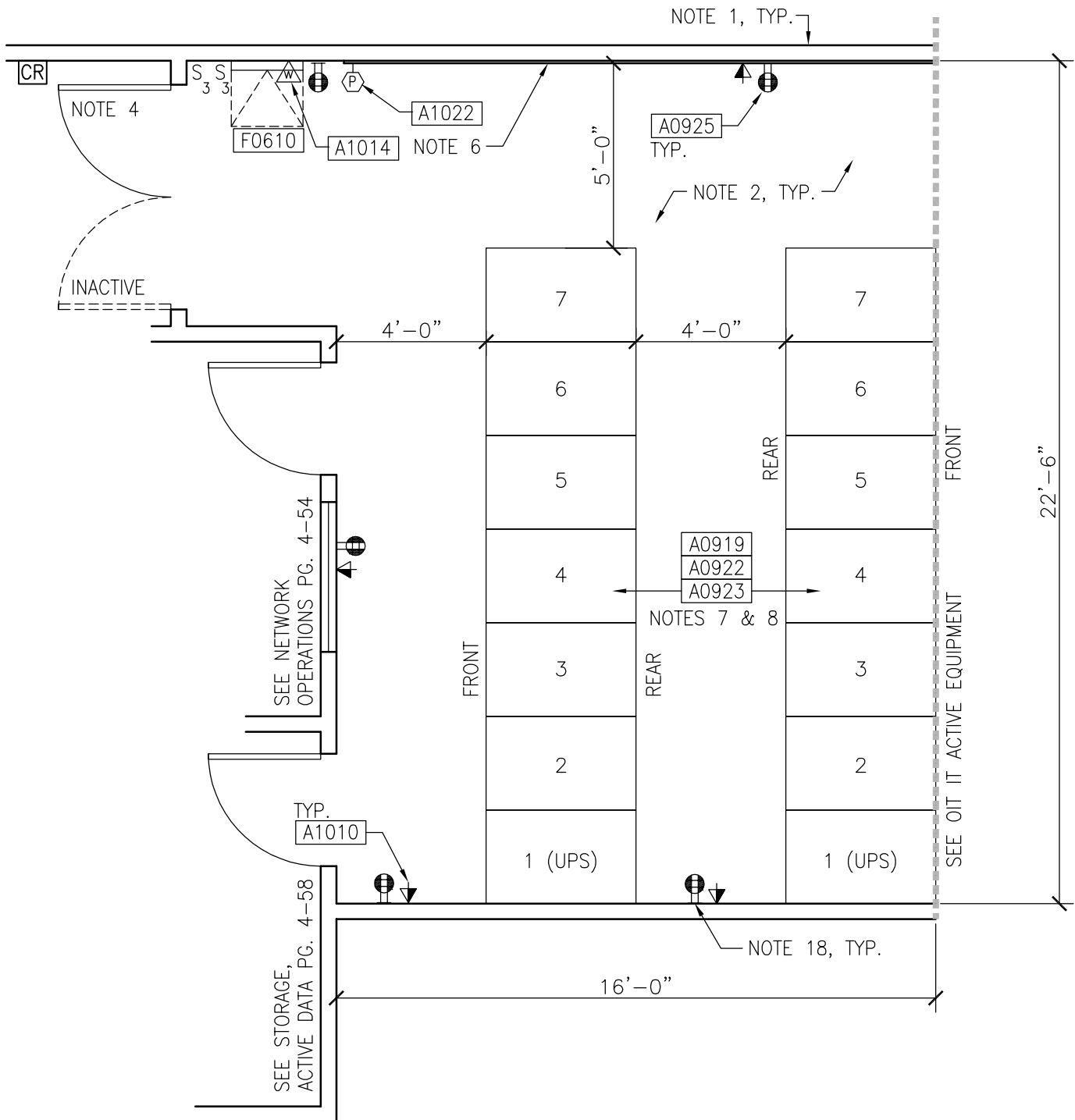

*MINIMUM ROOM SIZE IS 165 NSF. ROOM SHOWN IS BASED ON A FACILITY SIZE OF 300,000 NSF, AND HAS BEEN NORMALIZED TO MATCH ADJACENT SPACE.

SEE DESIGN STANDARDS PAGE OF THIS GUIDE PLATE FOR NUMBERED NOTES.

SEE SECTION 1 FOR SYMBOL LEGEND.

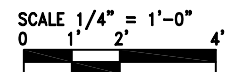

Note: Guide plates are graphical representations of selected room types, illustrating the integration of space, building systems (lights, HVAC, etc), and telecommunications equipment. The Design Team is responsible to perform the calculations to determine final quantities as well as location of each component for every project. Specific infrastructure design requirements are contained in PG 18-5: Equipment Guide List, PG 18-9: Space Planning Criteria, and PG 18-10: Design Manuals (by discipline) located in the VA's Technical Information Library (TIL) <http://www.cfm.va.gov/TIL/>.

Digital Telephone (PBX) Equipment (TEDP1)

400 NSF*

Reflected Ceiling Plan

37.2 NSM

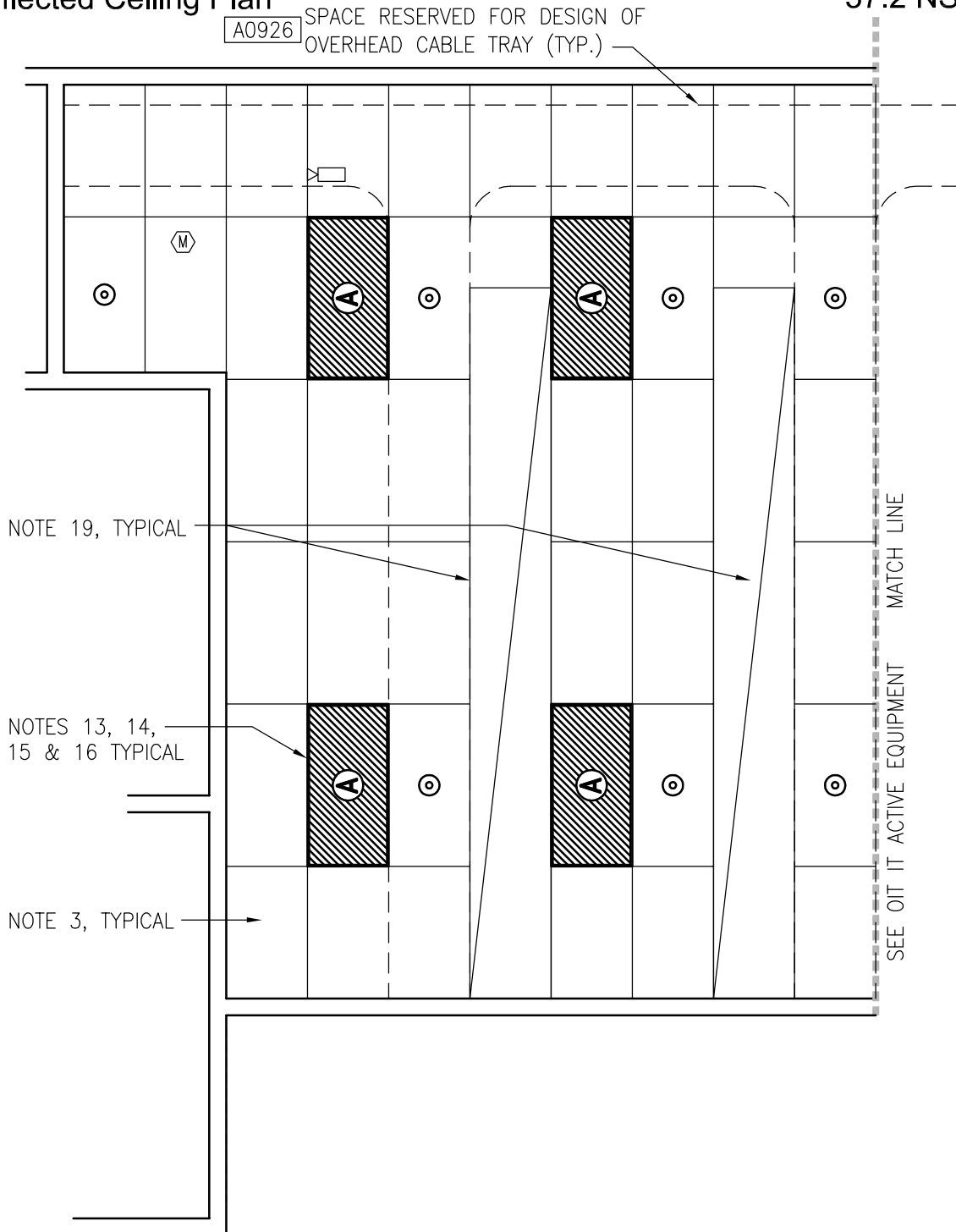

*MINIMUM ROOM SIZE IS 165 NSF. ROOM SHOWN IS BASED ON A FACILITY SIZE OF 300,000 NSF, AND HAS BEEN NORMALIZED TO MATCH ADJACENT SPACE.

SEE DESIGN STANDARDS PAGE OF THIS GUIDE PLATE FOR NUMBERED NOTES.

SEE SECTION 1 FOR SYMBOL LEGEND.

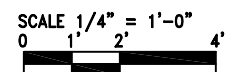

Note: Guide plates are graphical representations of selected room types, illustrating the integration of space, building systems (lights, HVAC, etc), and telecommunications equipment. The Design Team is responsible to perform the calculations to determine final quantities as well as location of each component for every project. Specific infrastructure design requirements are contained in PG 18-5: Equipment Guide List, PG 18-9: Space Planning Criteria, and PG 18-10: Design Manuals (by discipline) located in the VA's Technical Information Library (TIL) <http://www.cfm.va.gov/TIL/>.

Digital Telephone (PBX) Equipment (TEDP1)

Design Standards

ARCHITECTURAL

Ceiling / Ceiling Height:	Note 3
Wall Finish:	GWB-P; Notes 1 and 6
Wainscot:	--
Base:	RB
Floor Finish:	Note 2
Slab Depression:	24"
Sound Protection:	STC 40
Doors:	Note 4

Notes:

- 1) Partitions and openings to comply with VA PSDM.
- 2) Access floor.
- 3) Clean Room acoustical ceiling panels. Align ceiling grid with access floor panels. 10'-6" ceiling height (measured from top of access floor to underside of suspended grid) is required for cabling above equipment racks and cabinets.
- 4) Door Size: single S (36"W x 84"H); pair SS (36"W x 84"H each leaf). Each computer room shall have at least one set of paired doors for equipment access. All doors shall swing out from the MCR. Provide suitable alcoves to corridor(s).
- 5) Wire Mesh Partition from top of access floor to underside of suspended ceiling; MCS 10 22 13.
- 6) Painted 3/4-inch fire retardant plywood over GWB where indicated. Area reserved (1 x 17.5 feet) for wall-mounted passive termination equipment for voice backbone cabling.

SPECIAL EQUIPMENT

Notes:

- 7) Racks and cabinets are CC. See Equipment List. See *Equipment Modules* page 4-2 for typical rack and cabinet dimensions and clearances,
- 8) Systems are VV.
- 9) Overhead conduits carrying OIT and FMS backbone cabling to TRs or Demarcs are not shown.
- 10) Provide Telecommunications Bonding Backbone (EDM 8.3), and conduit connectivity (EDM Table 7-1).

SPECIAL EQUIPMENT (continued)

- 11) Provide clean agent fire suppression in room, above ceiling, and under access floor. Clean agent fire suppression heads are not shown.
- 12) Provide moisture detection sensors under access floor.

LIGHTING

General: Refer to Electrical Design Manual

Notes:

- 13) All lighting shall be connected to the Critical Branch of the ESS (EDM 4.6).
- 14) 50 average maintained fc illumination level.
- 15) Recessed four-lamp fluorescent lighting fixture with acrylic lens and F32T8 lamps, 3500°K, CRI=70 (minimum).
- 16) Exact quantity, location, and lamping of fixtures shall be chosen to meet the footcandle requirement.

POWER

General: Refer to Electrical Design Manual

Emergency: Refer to Electrical Design Manual

Notes:

- 17) Refer to Technical Considerations in Section 2 of this Design Guide.
- 18) All receptacles and equipment shall be connected to UPS power (EDM 5.3), and the UPS equipment connected to the Critical Branch of the ESS (EDM 4.6).

COMMUNICATION/SPECIAL SYSTEMS

Data:	Yes
Telephone:	Yes
Cable Television:	--
Duress Alarm:	Yes
Electronic Access and Door Control:	Yes
Intercom:	--
Motion Intrusion Detection (MID):	Yes
Nurse Call, Code One (Blue):	--
Public Address:	--
Security Surveillance Television (SSTV)	Yes
VA Satellite TV:	--
Video Teleconferencing (VTEL):	--
Notes:	--

Continued on Next Page



Digital Telephone (PBX) Equipment (TEDP1)

Design Standards (continued)

HEATING, VENTILATING AND AIR CONDITIONING

Inside Design Conditions:

Indoor design temperature shall be 64-75 degrees F, with relative humidity between 30% and 55%.

Notes:

- 19) Hot aisle containment encloses and captures the hot IT exhaust, and ducts the hot air directly back to the air handling equipment in the HVAC and Equipment, Computer Area (ITAC1) room. Refer to Technical Considerations in Section 2 of this Design Guide.

PLUMBING AND MEDICAL GASES

Cold Water:	--
Hot Water:	--
Laboratory Air:	--
Laboratory Vacuum:	--
Sanitary Drain:	--
Reagent Grade Water:	--
Medical Air:	--
Medical Vacuum:	--
Oxygen:	--

Notes:

- 20) Do not run pipe containing liquids (such as water, drain, or steam) above this space; except as required to provide fire suppression for this space only.



Digital Telephone (PBX) Equipment (TEDP1)

Equipment Guide List

JSN	NAME	QTY	AI	DESCRIPTION	SPEC
A0926	Tray, Cable, for Communications Systems	AR	CC	Cable trays for communications systems.	26 05 36
A0919	Cabinet, With Internal Equipment Mounting Rack, Steel	AR	CC	Cabinet with internal equipment mounting rack, steel.	27 11 00
A0923	Wire Management System	AR	CC	Wire management system.	27 31 00
A0920	Cross-Connection System (CCS)	AR	CC	Equipment breakout, Termination Connector, (or Bulkhead), and Patch Panels	27 11 00
A0922	Voice Communications Switching and Routing Equipment	AR	CC	Voice Communications Switching and Routing Equipment	27 31 00
A1010	Telecommunication Outlet	AR	CC	Telecommunication outlet location.	27 15 00
A1014	Telephone, Wall Mounted, 1 Line, With Speaker	1	VV	Telephone, wall mounted, 1 line, with speaker.	
F0610	Desk Folding, W/M	1	CC	Wall mounted fold down desk, approximately 18" H x 23" W x 3" D, with writing surface, pencil-pen rack and multiple form holders.	12 31 00 Or 12 32 00
A0925	Receptacle, Electrical, Quadruplex	AR	CC	Receptacle, quadruplex, 120 V.	26 27 26
A1022	Button, Alarm, Security/Duress	AR	CC	Alarm button, Security/Duress.	27 52 31
				End of Equipment List	



This page intentionally left blank.

OIT IT Active Equipment (ITAE1)

360 NSF*

Floor Plan

33.4 NSM

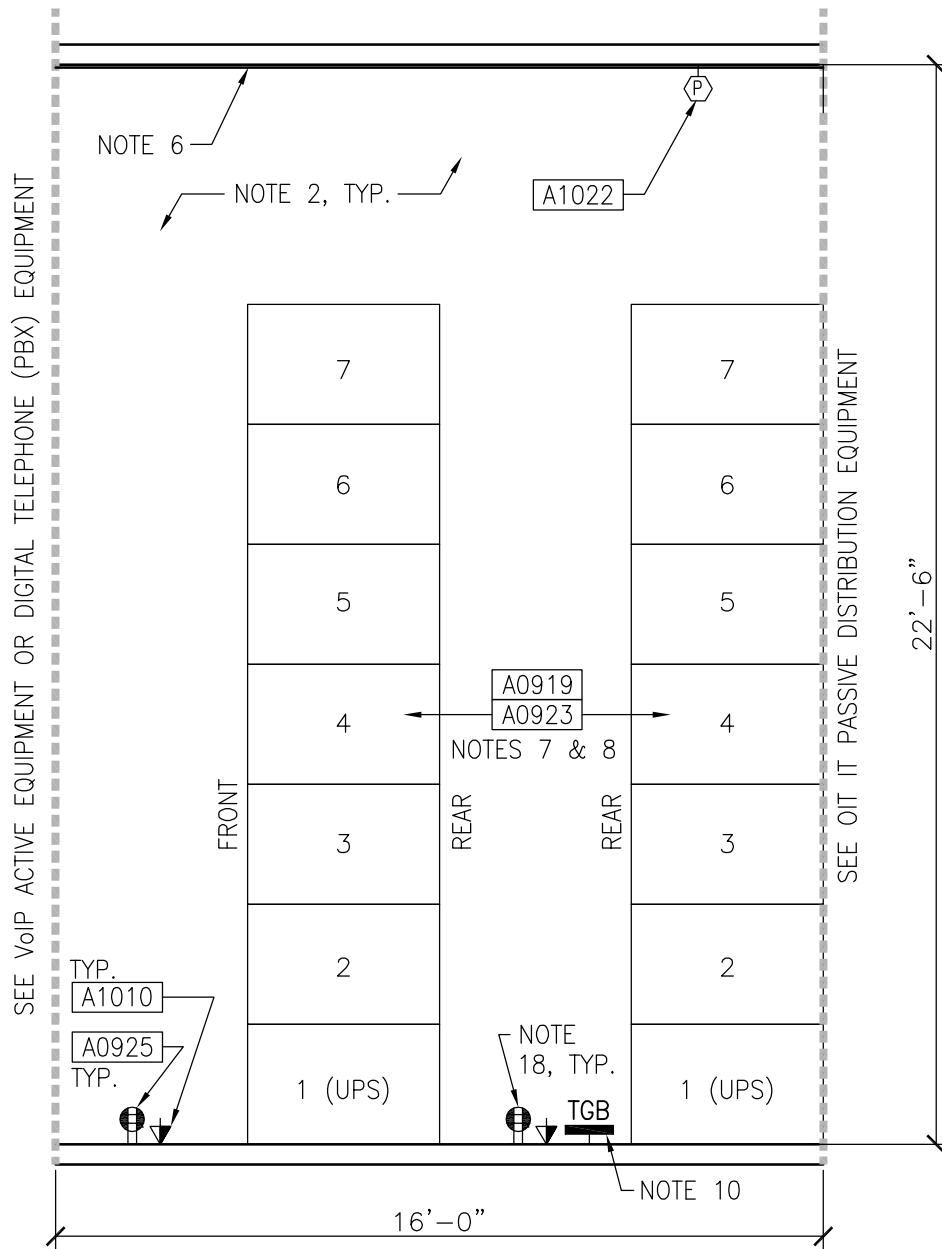

*MINIMUM ROOM SIZE IS 160 NSF. ROOM SHOWN IS BASED ON A FACILITY SIZE OF 300,000 NSF, AND HAS BEEN NORMALIZED TO MATCH ADJACENT SPACE.

SEE DESIGN STANDARDS PAGE OF THIS GUIDE PLATE FOR NUMBERED NOTES.

SEE SECTION 1 FOR SYMBOL LEGEND.

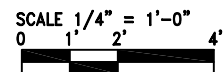

Note: Guide plates are graphical representations of selected room types, illustrating the integration of space, building systems (lights, HVAC, etc), and telecommunications equipment. The Design Team is responsible to perform the calculations to determine final quantities as well as location of each component for every project. Specific infrastructure design requirements are contained in PG 18-5: Equipment Guide List, PG 18-9: Space Planning Criteria, and PG 18-10: Design Manuals (by discipline) located in the VA's Technical Information Library (TIL) <http://www.cfm.va.gov/TIL/>.

OIT Active Equipment (ITAE1)
Reflected Ceiling Plan

360 NSF*
33.4 NSM

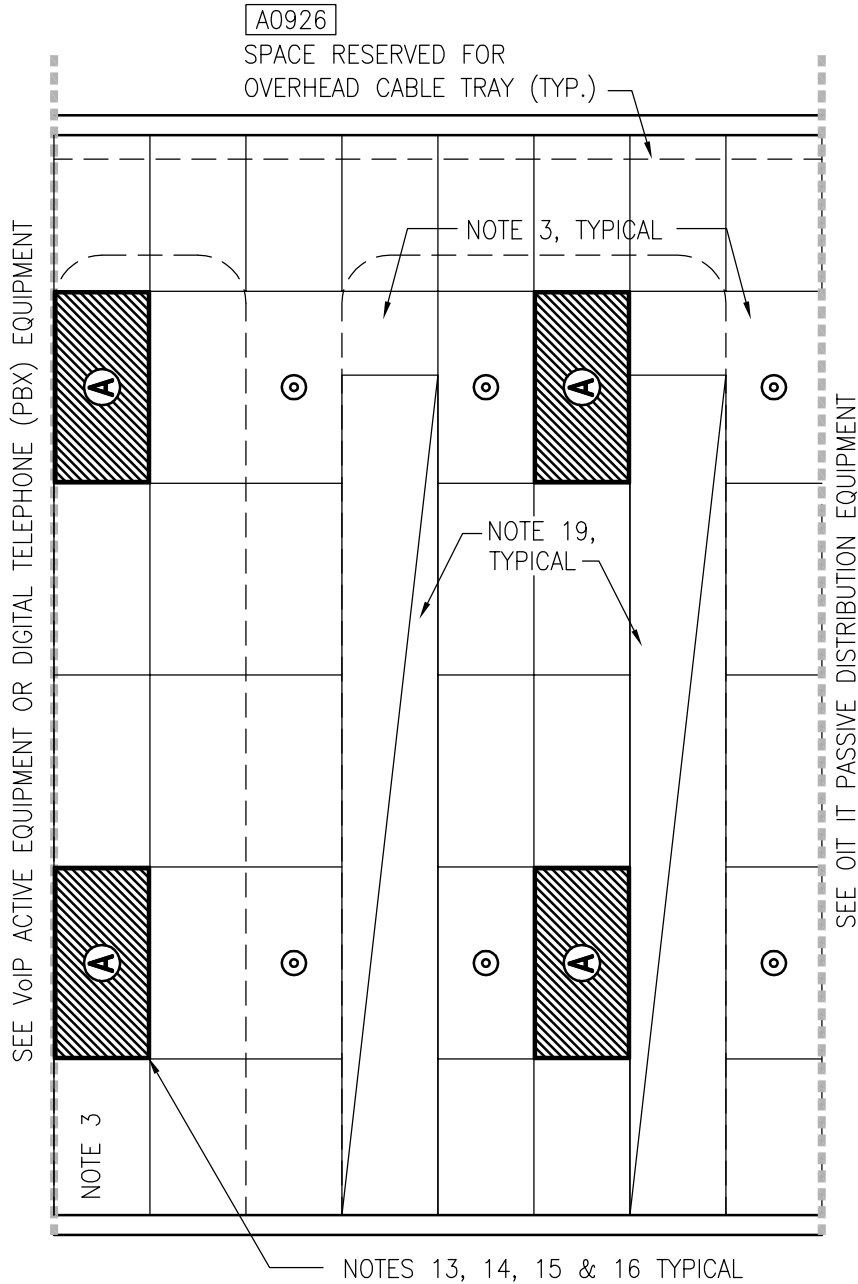

*MINIMUM ROOM SIZE IS 160 NSF. ROOM SHOWN IS BASED ON A FACILITY SIZE OF 300,000 NSF, AND HAS BEEN NORMALIZED TO MATCH ADJACENT SPACE.

SEE DESIGN STANDARDS PAGE OF THIS GUIDE PLATE FOR NUMBERED NOTES.

SEE SECTION 1 FOR SYMBOL LEGEND.

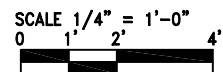

Note: Guide plates are graphical representations of selected room types, illustrating the integration of space, building systems (lights, HVAC, etc), and telecommunications equipment. The Design Team is responsible to perform the calculations to determine final quantities as well as location of each component for every project. Specific infrastructure design requirements are contained in PG 18-5: Equipment Guide List, PG 18-9: Space Planning Criteria, and PG 18-10: Design Manuals (by discipline) located in the VA's Technical Information Library (TIL) <http://www.cfm.va.gov/TIL/>.

OIT IT Active Equipment (ITAE1)

Design Standards

ARCHITECTURAL

Ceiling / Ceiling Height:	Note 3
Wall Finish:	GWB-P; Notes 1 and 6
Wainscot:	--
Base:	RB
Floor Finish:	Note 2
Slab Depression:	24"
Sound Protection:	STC 40
Doors:	Note 4

Notes:

- 1) Partitions and openings to comply with VA PSDM.
- 2) Access floor.
- 3) Clean Room acoustical ceiling panels. Align ceiling grid with access floor panels. 10'-6" ceiling height (measured from top of access floor to underside of suspended grid) is required for cabling above equipment racks and cabinets.
- 4) Door Size: single S (36"W x 84"H); pair SS (36"W x 84"H each leaf). Each computer room shall have at least one set of paired doors for equipment access. All doors shall swing out from the MCR. Provide suitable alcoves to corridor(s).
- 5) Wire Mesh Partition from top of access floor to underside of suspended ceiling; MCS 10 22 13.
- 6) Painted ¾-inch fire retardant plywood over GWB where indicated. Area reserved (1 x 15 feet for VoIP, 1 x 17.5 feet for PBX) for wall-mounted passive termination equipment for voice backbone cabling.

SPECIAL EQUIPMENT

Notes:

- 7) Racks and cabinets are CC. See Equipment List. See *Equipment Modules* page 4-2 for typical rack and cabinet dimensions and clearances,
- 8) Systems are VV.
- 9) Overhead conduits carrying OIT and FMS backbone cabling to TRs are not shown.
- 10) Provide Telecommunications Bonding Backbone (EDM 8.3), and conduit connectivity (EDM Table 7-1).

SPECIAL EQUIPMENT (continued)

- 11) Provide clean agent fire suppression in room, above ceiling, and under access floor. Clean agent fire suppression heads are not shown.
- 12) Provide moisture detection sensors under access floor.

LIGHTING

General: Refer to Electrical Design Manual

Notes:

- 13) All lighting shall be connected to the Critical Branch of the ESS (EDM 4.6).
- 14) 50 average maintained fc illumination level.
- 15) Recessed four-lamp fluorescent lighting fixture with acrylic lens and F32T8 lamps, 3500°K, CRI=70 (minimum).
- 16) Exact quantity, location, and lamping of fixtures shall be chosen to meet the footcandle requirement.

POWER

General: Refer to Electrical Design Manual

Emergency: Refer to Electrical Design Manual

Notes:

- 17) Refer to Technical Considerations in Section 2 of this Design Guide.
- 18) All receptacles and equipment shall be connected to UPS power (EDM 5.3), and the UPS equipment connected to the Critical Branch of the ESS (EDM 4.6).

COMMUNICATION/SPECIAL SYSTEMS

Data:	Yes
Telephone:	Yes
Cable Television:	--
Duress Alarm:	Yes
Electronic Access and Door Control:	Yes
Intercom:	--
Motion Intrusion Detection (MID):	Yes
Nurse Call, Code One (Blue):	--
Public Address:	--
Security Surveillance Television (SSTV)	Yes
VA Satellite TV:	--
Video Teleconferencing (VTEL):	--
Notes:	--

Continued on Next Page



OIT IT Active Equipment (ITAE1)

Design Standards (continued)

HEATING, VENTILATING AND AIR CONDITIONING

Inside Design Conditions:

Indoor design temperature shall be 64-75 degrees F, with relative humidity between 30% and 55%.

Notes:

- 19) Hot aisle containment encloses and captures the hot IT exhaust, and ducts the hot air directly back to the air handling equipment in the HVAC and Equipment, Computer Area (ITAC1) room. Refer to Technical Considerations in Section 2 of this Design Guide.

PLUMBING AND MEDICAL GASES

Cold Water:	--
Hot Water:	--
Laboratory Air:	--
Laboratory Vacuum:	--
Sanitary Drain:	--
Reagent Grade Water:	--
Medical Air:	--
Medical Vacuum:	--
Oxygen:	--

Notes:

- 20) Do not run pipe containing liquids (such as water, drain, or steam) above this space; except as required to provide fire suppression for this space only.



OIT IT Active Equipment (ITAE1)

Equipment Guide List

JSN	NAME	QTY	AI	DESCRIPTION	SPEC
A0926	Tray, Cable, for Communications Systems	AR	CC	Cable trays for communications systems.	26 05 36
A0919	Cabinet, With Internal Equipment Mounting Rack, Steel	AR	CC	Cabinet with internal equipment mounting rack, steel.	27 11 00
A0923	Wire Management System	AR	CC	Wire management system.	27 31 00
A1010	Telecommunication Outlet	AR	CC	Telecommunication outlet location.	27 15 00
A0925	Receptacle, Electrical, Quadraplex	AR	CC	Receptacle, quadraplex, 120 V.	26 27 26
A1022	Button, Alarm, Security/Duress	AR	CC	Alarm button, Security/Duress.	27 52 31
				End of Equipment List	



This page intentionally left blank.

OIT Passive Distribution Equipment (ITPE1)

225 NSF*

Floor Plan

20.9 NSM

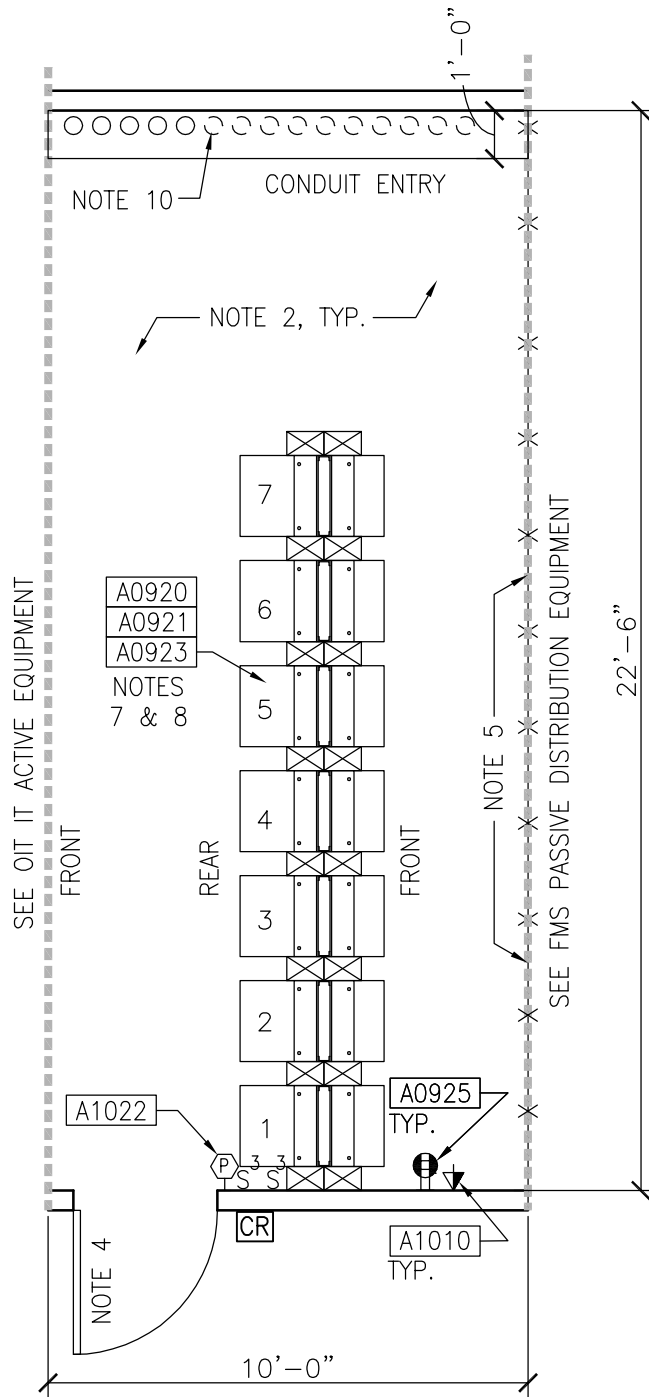

*MINIMUM ROOM SIZE IS 100 NSF. ROOM SHOWN IS BASED ON A FACILITY SIZE OF 300,000 NSF, AND HAS BEEN NORMALIZED TO MATCH ADJACENT SPACE.

SEE DESIGN STANDARDS PAGE OF THIS GUIDE PLATE FOR NUMBERED NOTES.

SEE SECTION 1 FOR SYMBOL LEGEND.

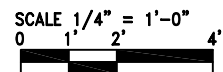

Note: Guide plates are graphical representations of selected room types, illustrating the integration of space, building systems (lights, HVAC, etc), and telecommunications equipment. The Design Team is responsible to perform the calculations to determine final quantities as well as location of each component for every project. Specific infrastructure design requirements are contained in PG 18-5: Equipment Guide List, PG 18-9: Space Planning Criteria, and PG 18-10: Design Manuals (by discipline) located in the VA's Technical Information Library (TIL) <http://www.cfm.va.gov/TIL/>.

OIT Passive Distribution Equipment (ITPE1) Reflected Ceiling Plan

225 NSF*
20.9 NSM

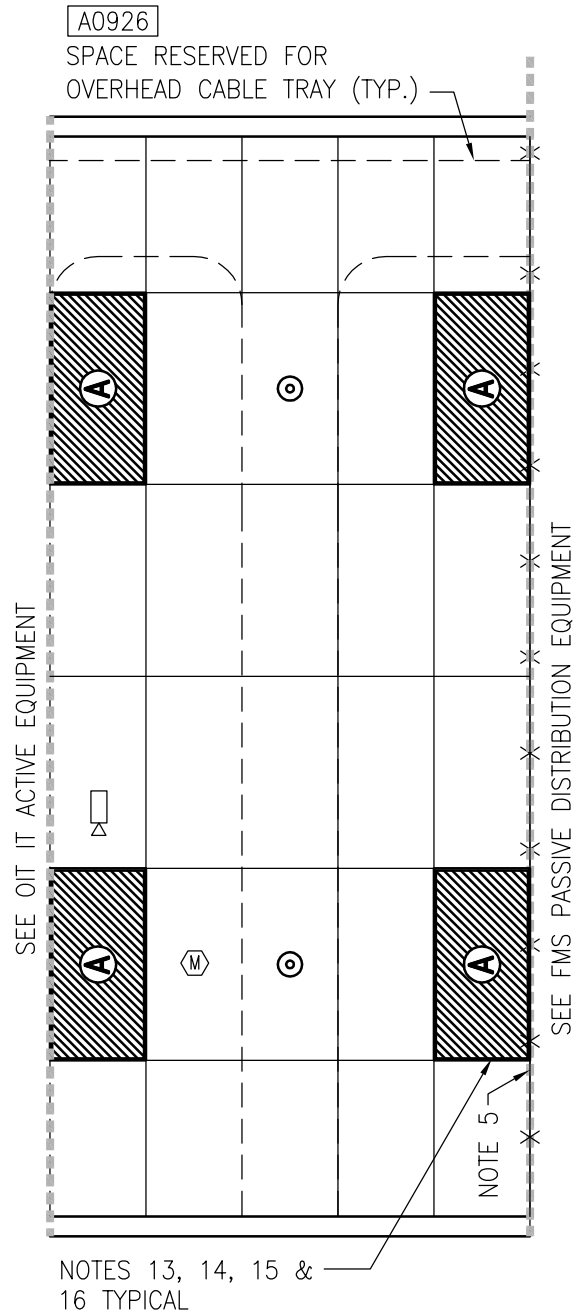

*MINIMUM ROOM SIZE IS 100 NSF. ROOM SHOWN IS BASED ON A FACILITY SIZE OF 300,000 NSF, AND HAS BEEN NORMALIZED TO MATCH ADJACENT SPACE.

SEE DESIGN STANDARDS PAGE OF THIS GUIDE PLATE FOR NUMBERED NOTES.

SEE SECTION 1 FOR SYMBOL LEGEND.

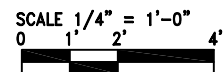

Note: Guide plates are graphical representations of selected room types, illustrating the integration of space, building systems (lights, HVAC, etc), and telecommunications equipment. The Design Team is responsible to perform the calculations to determine final quantities as well as location of each component for every project. Specific infrastructure design requirements are contained in PG 18-5: Equipment Guide List, PG 18-9: Space Planning Criteria, and PG 18-10: Design Manuals (by discipline) located in the VA's Technical Information Library (TIL) <http://www.cfm.va.gov/TIL/>.

OIT IT Passive Distribution Equipment (ITPE1)

Design Standards

ARCHITECTURAL

Ceiling / Ceiling Height:	Note 3
Wall Finish:	GWB-P; Notes 1 and 6
Wainscot:	--
Base:	RB
Floor Finish:	Note 2
Slab Depression:	24"
Sound Protection:	STC 40
Doors:	Note 4

Notes:

- 1) Partitions and openings to comply with VA PSDM.
- 2) Access floor.
- 3) Clean Room acoustical ceiling panels. Align ceiling grid with access floor panels. 10'-6" ceiling height (measured from top of access floor to underside of suspended grid) is required for cabling above equipment racks and cabinets.
- 4) Door Size: single S (36"W x 84"H); pair SS (36"W x 84"H each leaf). Each computer room shall have at least one set of paired doors for equipment access. All doors shall swing out from the MCR. Provide suitable alcoves to corridor(s).
- 5) Wire Mesh Partition from top of access floor to underside of suspended ceiling; MCS 10 22 13.
- 6) Painted ¾-inch fire retardant plywood over GWB where indicated. Area reserved (1 x 15 feet for VoIP, 1 x 17.5 feet for PBX) for wall-mounted passive termination equipment for voice backbone cabling.

SPECIAL EQUIPMENT

Notes:

- 7) Racks and cabinets are CC. See Equipment List. See *Equipment Modules* page 4-2 for typical rack and cabinet dimensions and clearances,
- 8) Systems are VV.
- 9) Overhead conduits carrying OIT and FMS backbone cabling to TRs are not shown.
- 10) Provide Telecommunications Bonding Backbone (EDM 8.3), and conduit connectivity (EDM Table 7-1).

SPECIAL EQUIPMENT (continued)

- 11) Provide clean agent fire suppression in room, above ceiling, and under access floor. Clean agent fire suppression heads are not shown.
- 12) Provide moisture detection sensors under access floor.

LIGHTING

General: Refer to Electrical Design Manual

Notes:

- 13) All lighting shall be connected to the Critical Branch of the ESS (EDM 4.6).
- 14) 50 average maintained fc illumination level.
- 15) Recessed four-lamp fluorescent lighting fixture with acrylic lens and F32T8 lamps, 3500°K, CRI=70 (minimum).
- 16) Exact quantity, location, and lamping of fixtures shall be chosen to meet the footcandle requirement.

POWER

General: Refer to Electrical Design Manual

Emergency: Refer to Electrical Design Manual

Notes:

- 17) Refer to Technical Considerations in Section 2 of this Design Guide.
- 18) All receptacles and equipment shall be connected to UPS power (EDM 5.3), and the UPS equipment connected to the Critical Branch of the ESS (EDM 4.6).

COMMUNICATION/SPECIAL SYSTEMS

Data:	Yes
Telephone:	Yes
Cable Television:	--
Duress Alarm:	Yes
Electronic Access and Door Control:	Yes
Intercom:	--
Motion Intrusion Detection (MID):	Yes
Nurse Call, Code One (Blue):	--
Public Address:	--
Security Surveillance Television (SSTV)	Yes
VA Satellite TV:	--
Video Teleconferencing (VTEL):	--
Notes:	--

Continued on Next Page



OIT IT Passive Distribution Equipment (ITPE1)

Design Standards (continued)

HEATING, VENTILATING AND AIR CONDITIONING

Inside Design Conditions:

Indoor design temperature shall be 64-75 degrees F, with relative humidity between 30% and 55%.

Notes:

- 19) Hot aisle containment encloses and captures the hot IT exhaust, and ducts the hot air directly back to the air handling equipment in the HVAC and Equipment, Computer Area (ITAC1) room. Refer to Technical Considerations in Section 2 of this Design Guide.

PLUMBING AND MEDICAL GASES

Cold Water:	--
Hot Water:	--
Laboratory Air:	--
Laboratory Vacuum:	--
Sanitary Drain:	--
Reagent Grade Water:	--
Medical Air:	--
Medical Vacuum:	--
Oxygen:	--

Notes:

- 20) Do not run pipe containing liquids (such as water, drain, or steam) above this space; except as required to provide fire suppression for this space only.



OIT IT Passive Distribution Equipment (ITPE1)

Equipment Guide List

JSN	NAME	QTY	AI	DESCRIPTION	SPEC
A0926	Tray, Cable, for Communications Systems	AR	CC	Cable trays for communications systems.	26 05 36
A0921	Rack, Equipment, Freestanding, Steel	AR	CC	Equipment rack, freestanding, steel.	27 31 00
A0923	Wire Management System	AR	CC	Wire management system.	27 31 00
A0920	Cross-Connection System (CCS)	AR	CC	Equipment breakout, Termination Connector, (or Bulkhead), and Patch Panels	27 11 00
A1010	Telecommunication Outlet	AR	CC	Telecommunication outlet location.	27 15 00
A0925	Receptacle, Electrical, Quadraplex	AR	CC	Receptacle, quadraplex, 120 V.	26 27 26
A1022	Button, Alarm, Security/Duress	AR	CC	Alarm button, Security/Duress.	27 52 31
				End of Equipment List	



This page intentionally left blank.

FMS Passive Distribution Equipment (FMPE1)

225 NSF*

Floor Plan

20.9 NSM

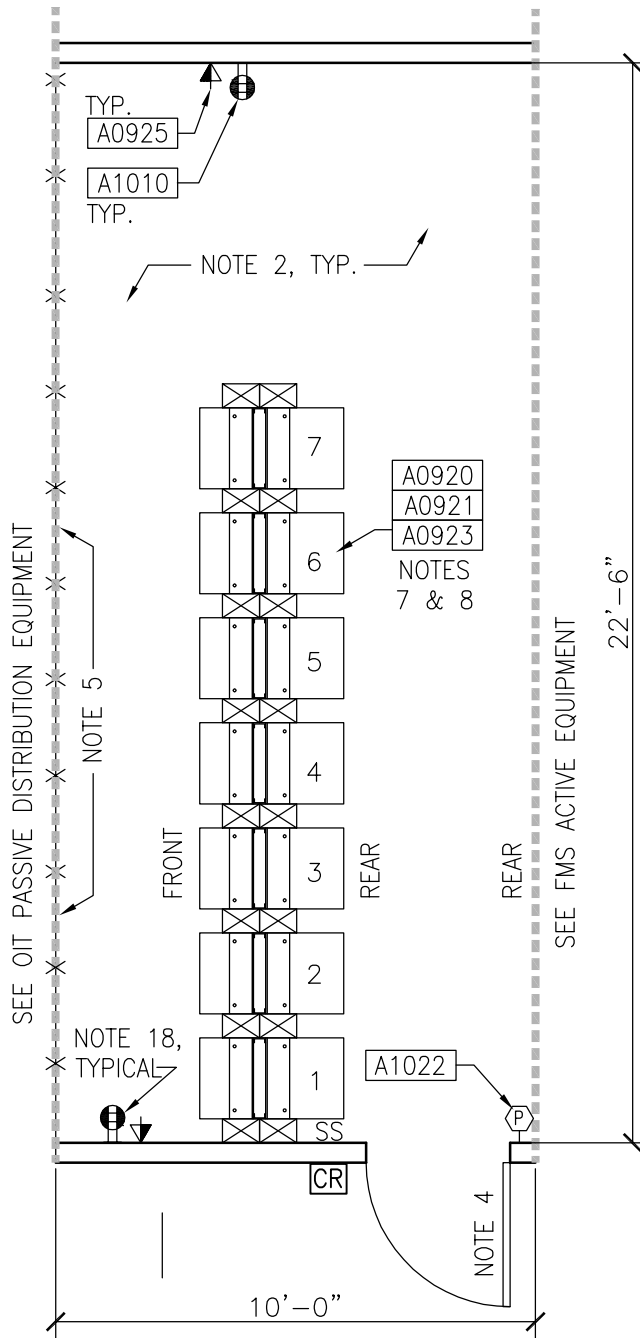

*MINIMUM ROOM SIZE IS 100 NSF. ROOM SHOWN IS BASED ON A FACILITY SIZE OF 300,000 NSF, AND HAS BEEN NORMALIZED TO MATCH ADJACENT SPACE.

SEE DESIGN STANDARDS PAGE OF THIS GUIDE PLATE FOR NUMBERED NOTES.

SEE SECTION 1 FOR SYMBOL LEGEND.

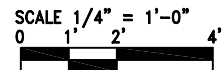

Note: Guide plates are graphical representations of selected room types, illustrating the integration of space, building systems (lights, HVAC, etc), and telecommunications equipment. The Design Team is responsible to perform the calculations to determine final quantities as well as location of each component for every project. Specific infrastructure design requirements are contained in PG 18-5: Equipment Guide List, PG 18-9: Space Planning Criteria, and PG 18-10: Design Manuals (by discipline) located in the VA's Technical Information Library (TIL) <http://www.cfm.va.gov/TIL/>.

FMS Passive Distribution Equipment (FMPE1)
Reflected Ceiling Plan

225 NSF*
20.9 NSM

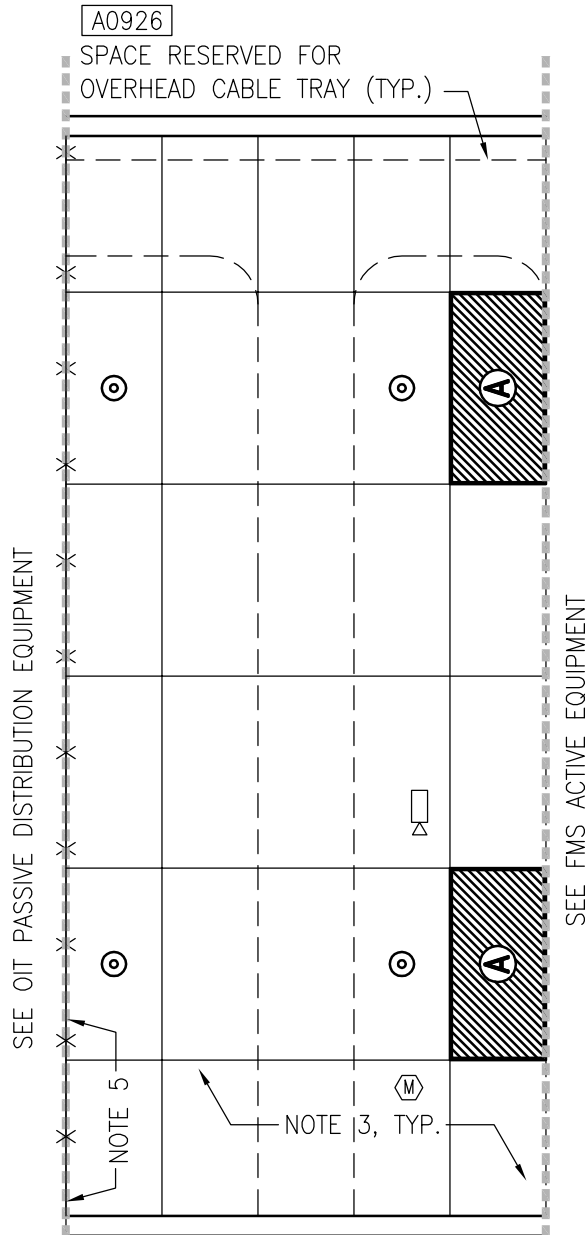

*MINIMUM ROOM SIZE IS 100 NSF. ROOM SHOWN IS BASED ON A FACILITY SIZE OF 300,000 NSF, AND HAS BEEN NORMALIZED TO MATCH ADJACENT SPACE.

SEE DESIGN STANDARDS PAGE OF THIS GUIDE PLATE FOR NUMBERED NOTES.

SEE SECTION 1 FOR SYMBOL LEGEND.

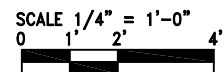

Note: Guide plates are graphical representations of selected room types, illustrating the integration of space, building systems (lights, HVAC, etc), and telecommunications equipment. The Design Team is responsible to perform the calculations to determine final quantities as well as location of each component for every project. Specific infrastructure design requirements are contained in PG 18-5: Equipment Guide List, PG 18-9: Space Planning Criteria, and PG 18-10: Design Manuals (by discipline) located in the VA's Technical Information Library (TIL) <http://www.cfm.va.gov/TIL/>.

FMS Passive Distribution Equipment (FMPE1)

Design Standards

ARCHITECTURAL

Ceiling / Ceiling Height:	Note 3
Wall Finish:	GWB-P; Notes 1 and 6
Wainscot:	--
Base:	RB
Floor Finish:	Note 2
Slab Depression:	24"
Sound Protection:	STC 40
Doors:	Note 4

Notes:

- 1) Partitions and openings to comply with VA PSDM.
- 2) Access floor.
- 3) Clean Room acoustical ceiling panels. Align ceiling grid with access floor panels. 10'-6" ceiling height (measured from top of access floor to underside of suspended grid) is required for cabling above equipment racks and cabinets.
- 4) Door Size: single S (36"W x 84"H); pair SS (36"W x 84"H each leaf). Each computer room shall have at least one set of paired doors for equipment access. All doors shall swing out from the MCR. Provide suitable alcoves to corridor(s).
- 5) Wire Mesh Partition from top of access floor to underside of suspended ceiling; MCS 10 22 13.
- 6) Painted ¾-inch fire retardant plywood over GWB where indicated. Area reserved (1 x 15 feet for VoIP, 1 x 17.5 feet for PBX) for wall-mounted passive termination equipment for voice backbone cabling.

SPECIAL EQUIPMENT

Notes:

- 7) Racks and cabinets are CC. See Equipment List. See *Equipment Modules* page 4-2 for typical rack and cabinet dimensions and clearances,
- 8) Systems are CC.
- 9) Overhead conduits carrying OIT and FMS backbone cabling to TRs are not shown.
- 10) Provide Telecommunications Bonding Backbone (EDM 8.3), and conduit connectivity (EDM Table 7-1).

SPECIAL EQUIPMENT (continued)

- 11) Provide clean agent fire suppression in room, above ceiling, and under access floor. Clean agent fire suppression heads are not shown.
- 12) Provide moisture detection sensors under access floor.

LIGHTING

General: Refer to Electrical Design Manual

Notes:

- 13) All lighting shall be connected to the Critical Branch of the ESS (EDM 4.6).
- 14) 50 average maintained fc illumination level.
- 15) Recessed four-lamp fluorescent lighting fixture with acrylic lens and F32T8 lamps, 3500°K, CRI=70 (minimum).
- 16) Exact quantity, location, and lamping of fixtures shall be chosen to meet the footcandle requirement.

POWER

General: Refer to Electrical Design Manual

Emergency: Refer to Electrical Design Manual

Notes:

- 17) Refer to Technical Considerations in Section 2 of this Design Guide.
- 18) All receptacles and equipment shall be connected to UPS power (EDM 5.3), and the UPS equipment connected to the Critical Branch of the ESS (EDM 4.6).

COMMUNICATION/SPECIAL SYSTEMS

Data:	Yes
Telephone:	Yes
Cable Television:	--
Duress Alarm:	Yes
Electronic Access and Door Control:	Yes
Intercom:	--
Motion Intrusion Detection (MID):	Yes
Nurse Call, Code One (Blue):	--
Public Address:	--
Security Surveillance Television (SSTV)	Yes
VA Satellite TV:	--
Video Teleconferencing (VTEL):	--
Notes:	--

Continued on Next Page



FMS Passive Distribution Equipment (FMPE1)

Design Standards (continued)

HEATING, VENTILATING AND AIR CONDITIONING

Inside Design Conditions:

Indoor design temperature shall be 64-75 degrees F, with relative humidity between 30% and 55%.

Notes:

- 19) Hot aisle containment encloses and captures the hot IT exhaust, and ducts the hot air directly back to the air handling equipment in the HVAC and Equipment, Computer Area (ITAC1) room. Refer to Technical Considerations in Section 2 of this Design Guide.

PLUMBING AND MEDICAL GASES

Cold Water:	--
Hot Water:	--
Laboratory Air:	--
Laboratory Vacuum:	--
Sanitary Drain:	--
Reagent Grade Water:	--
Medical Air:	--
Medical Vacuum:	--
Oxygen:	--

Notes:

- 20) Do not run pipe containing liquids (such as water, drain, or steam) above this space; except as required to provide fire suppression for this space only.



FMS Passive Distribution Equipment (FMPE1)

Equipment Guide List

JSN	NAME	QTY	AI	DESCRIPTION	SPEC
A0926	Tray, Cable, for Communications Systems	AR	CC	Cable trays for communications systems.	26 05 36
A0921	Rack, Equipment, Freestanding, Steel	AR	CC	Equipment rack, freestanding, steel.	27 31 00
A0923	Wire Management System	AR	CC	Wire management system.	27 31 00
A0920	Cross-Connection System (CCS)	AR	CC	Equipment breakout, Termination Connector, (or Bulkhead), and Patch Panels	27 11 00
M0445	Master Antenna Television Equipment and Systems=	AR	CC	Equipment as required for fully operating Master Antenna Television (TV) system.	27 41 31
A1051	Public Address and Mass Notification Systems	AR	CC	Equipment as required for fully operating Emergency/Public Safety Public Address and Mass Notification communication (PA) system.	27 51 16
A1040	Intercommunications and Program Systems	AR	CC	Equipment as required for fully operating Intercommunications system.	27 51 23
A1050	Nurse Call Code Blue Systems	AR	CC	Equipment as required for fully operating Critical Service Nurse-Call and Life Safety Code Blue communication system.	27 52 23
A1022	Security Emergency Call / Duress Alarm / Telecommunications Systems	AR	CC	Equipment as required for fully operating Security Emergency Call / Duress Alarm / Telecommunications systems.	27 52 31
M0446	Miscellaneous Medical Systems	AR	CC	Equipment as required for installation and connection of the miscellaneous medical equipment and systems, including: Psychiatric (mental health) Security Unit Door Signal Systems; Narcotics Storage Signal Systems; and Elapsed Time Indicators.	27 52 41
X4100	Physical Access Control Systems	AR	CC	Equipment as required for fully functioning Physical Access Control System, referred to as the PACS.	28 13 11
A1020	Access Control System and Database Management	AR	CC	Equipment as required for fully functioning Access Control System and Database Management system.	28 13 16
A1026	Security Access Detection	AR	CC	Equipment as required for fully functioning Detection and Screening System, referred to as the Security Access Detection system.	28 13 53
A1023	Intrusion Detection System	AR	CC	Equipment as required for fully functioning Intrusion Detection System, referred to as IDS.	28 16 11
				(continued on next page)	



FMS Passive Distribution Equipment (FMPE1)

Equipment Guide List (continued)

JSN	NAME	QTY	AI	DESCRIPTION	SPEC
M0436	Video Surveillance	AR	CC	Equipment as required for fully functioning Video Surveillance System, which is identified as the Closed Circuit Television System, referred to as the CCTV System.	28 23 00
A1025	Electronic Personal Protection System	AR	CC	Equipment as required for fully functioning Duress-Panic Alarms, Emergency Phones/ Call-Boxes, and Intercom Systems, referred to as EPPS System.	28 26 00
A1052	Fire Detection and Alarm	AR	CC	Equipment as required for fully functioning Fire Detection and Alarm system.	28 31 00
A1010	Telecommunication Outlet	AR	CC	Telecommunication outlet location.	27 15 00
F0610	Desk Folding, W/M	3	CC	Wall mounted fold down desk, approximately 18" H x 23" W x 3" D, with writing surface, pencil-pen rack and multiple form holders.	12 31 00 Or 12 32 00
A0925	Receptacle, Electrical, Quadraplex	AR	CC	Receptacle, quadraplex, 120 V.	26 27 26
A1022	Button, Alarm, Security/Duress	AR	CC	Alarm button, Security/Duress.	27 52 31
				End of Equipment List	



FMS Active Equipment (FMAE1)

180 NSF*

Floor Plan

16.7 NSM

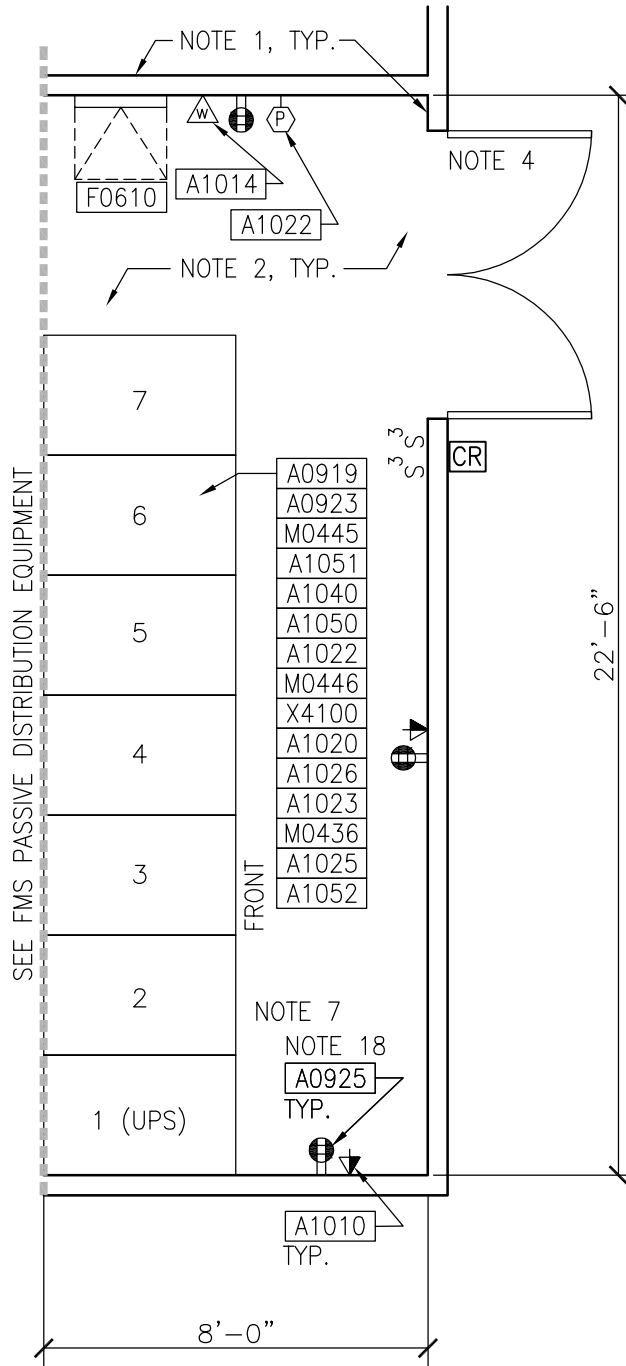

*MINIMUM ROOM SIZE IS 80 NSF. ROOM SHOWN IS BASED ON A FACILITY SIZE OF 300,000 NSF, AND HAS BEEN NORMALIZED TO MATCH ADJACENT SPACE.

SEE DESIGN STANDARDS PAGE OF THIS GUIDE PLATE FOR NUMBERED NOTES.

SEE SECTION 1 FOR SYMBOL LEGEND.

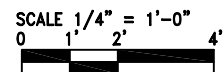

Note: Guide plates are graphical representations of selected room types, illustrating the integration of space, building systems (lights, HVAC, etc), and telecommunications equipment. The Design Team is responsible to perform the calculations to determine final quantities as well as location of each component for every project. Specific infrastructure design requirements are contained in PG 18-5: Equipment Guide List, PG 18-9: Space Planning Criteria, and PG 18-10: Design Manuals (by discipline) located in the VA's Technical Information Library (TIL) <http://www.cfm.va.gov/TIL/>.

FMS Active Equipment (FMAE1)
 Reflected Ceiling Plan

180 NSF*
 16.7 NSM

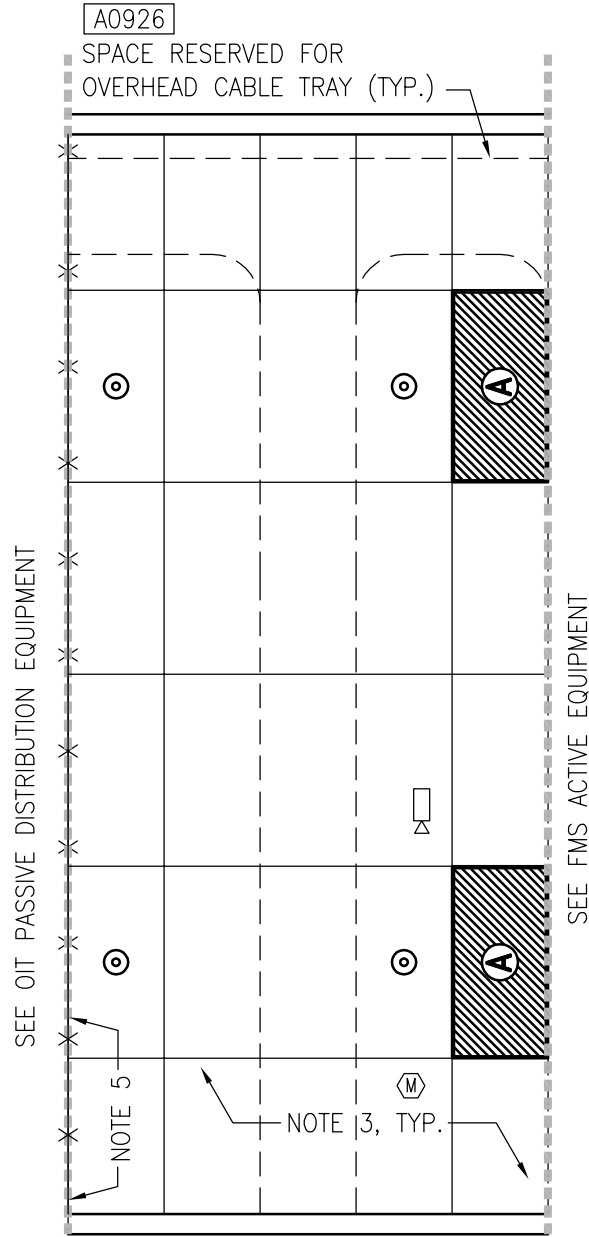

*MINIMUM ROOM SIZE IS 80 NSF. ROOM SHOWN IS BASED ON A FACILITY SIZE OF 300,000 NSF, AND HAS BEEN NORMALIZED TO MATCH ADJACENT SPACE.

SEE DESIGN STANDARDS PAGE OF THIS GUIDE PLATE FOR NUMBERED NOTES.

SEE SECTION 1 FOR SYMBOL LEGEND.

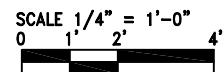

Note: Guide plates are graphical representations of selected room types, illustrating the integration of space, building systems (lights, HVAC, etc), and telecommunications equipment. The Design Team is responsible to perform the calculations to determine final quantities as well as location of each component for every project. Specific infrastructure design requirements are contained in PG 18-5: Equipment Guide List, PG 18-9: Space Planning Criteria, and PG 18-10: Design Manuals (by discipline) located in the VA's Technical Information Library (TIL)
<http://www.cfm.va.gov/TIL/>.

FMS Active Equipment (FMAE1)

Design Standards

ARCHITECTURAL

Ceiling / Ceiling Height:	Note 3
Wall Finish:	GWB-P; Notes 1 and 6
Wainscot:	--
Base:	RB
Floor Finish:	Note 2
Slab Depression:	24"
Sound Protection:	STC 40
Doors:	Note 4
Notes:	

- 1) Partitions and openings to comply with VA PSDM.
- 2) Access floor.
- 3) Clean Room acoustical ceiling panels. Align ceiling grid with access floor panels. 10'-6" ceiling height (measured from top of access floor to underside of suspended grid) is required for cabling above equipment racks and cabinets.
- 4) Door Size: single S (36"W x 84"H); pair SS (36"W x 84"H each leaf). Each computer room shall have at least one set of paired doors for equipment access. All doors shall swing out from the MCR. Provide suitable alcoves to corridor(s).
- 5) Wire Mesh Partition from top of access floor to underside of suspended ceiling; MCS 10 22 13.
- 6) Painted 3/4-inch fire retardant plywood over GWB where indicated. Area reserved (1 x 15 feet for VoIP, 1 x 17.5 feet for PBX) for wall-mounted passive termination equipment for voice backbone cabling.

SPECIAL EQUIPMENT

Notes:

- 7) Racks and cabinets are CC. See Equipment List. See *Equipment Modules* page 4-2 for typical rack and cabinet dimensions and clearances,
- 8) Systems are CC.
- 9) Overhead conduits carrying OIT and FMS backbone cabling to TRs are not shown.
- 10) Provide Telecommunications Bonding Backbone (EDM 8.3), and conduit connectivity (EDM Table 7-1).

SPECIAL EQUIPMENT (continued)

- 11) Provide clean agent fire suppression in room, above ceiling, and under access floor. Clean agent fire suppression heads are not shown.
- 12) Provide moisture detection sensors under access floor.

LIGHTING

General: Refer to Electrical Design Manual
Notes:

- 13) All lighting shall be connected to the Critical Branch of the ESS (EDM 4.6).
- 14) 50 average maintained fc illumination level.
- 15) Recessed four-lamp fluorescent lighting fixture with acrylic lens and F32T8 lamps, 3500°K, CRI=70 (minimum).
- 16) Exact quantity, location, and lamping of fixtures shall be chosen to meet the footcandle requirement.

POWER

General: Refer to Electrical Design Manual
Emergency: Refer to Electrical Design Manual
Notes:

- 17) Refer to Technical Considerations in Section 2 of this Design Guide.
- 18) All receptacles and equipment shall be connected to UPS power (EDM 5.3), and the UPS equipment connected to the Critical Branch of the ESS (EDM 4.6).

COMMUNICATION/SPECIAL SYSTEMS

Data:	Yes
Telephone:	Yes
Cable Television:	--
Duress Alarm:	Yes
Electronic Access and Door Control:	Yes
Intercom:	--
Motion Intrusion Detection (MID):	Yes
Nurse Call, Code One (Blue):	--
Public Address:	--
Security Surveillance Television (SSTV)	Yes
VA Satellite TV:	--
Video Teleconferencing (VTEL):	--
Notes:	--

Continued on Next Page

FMS Active Equipment (FMAE1)

Design Standards (continued)

HEATING, VENTILATING AND AIR CONDITIONING

Inside Design Conditions:

Indoor design temperature shall be 64-75 degrees F, with relative humidity between 30% and 55%.

Notes:

- 19) Hot aisle containment encloses and captures the hot IT exhaust, and ducts the hot air directly back to the air handling equipment in the HVAC and Equipment, Computer Area (ITAC1) room. Refer to Technical Considerations in Section 2 of this Design Guide.

PLUMBING AND MEDICAL GASES

Cold Water:	--
Hot Water:	--
Laboratory Air:	--
Laboratory Vacuum:	--
Sanitary Drain:	--
Reagent Grade Water:	--
Medical Air:	--
Medical Vacuum:	--
Oxygen:	--

Notes:

- 20) Do not run pipe containing liquids (such as water, drain, or steam) above this space; except as required to provide fire suppression for this space only.



FMS Active Equipment (FMAE1)

Equipment Guide List

JSN	NAME	QTY	AI	DESCRIPTION	SPEC
A0926	Tray, Cable, for Communications Systems	AR	CC	Cable trays for communications systems.	26 05 36
A0919	Cabinet, With Internal Equipment Mounting Rack, Steel	AR	CC	Cabinet with internal equipment mounting rack, steel.	27 11 00
A0923	Wire Management System	AR	CC	Wire management system.	27 31 00
M0445	Master Antenna Television Equipment and Systems=	AR	CC	Equipment as required for fully operating Master Antenna Television (TV) system.	27 41 31
A1051	Public Address and Mass Notification Systems	AR	CC	Equipment as required for fully operating Emergency/Public Safety Public Address and Mass Notification communication (PA) system.	27 51 16
A1040	Intercommunications and Program Systems	AR	CC	Equipment as required for fully operating Intercommunications system.	27 51 23
A1050	Nurse Call Code Blue Systems	AR	CC	Equipment as required for fully operating Critical Service Nurse-Call and Life Safety Code Blue communication system.	27 52 23
A1022	Security Emergency Call / Duress Alarm / Telecommunications Systems	AR	CC	Equipment as required for fully operating Security Emergency Call / Duress Alarm / Telecommunications systems.	27 52 31
M0446	Miscellaneous Medical Systems	AR	CC	Equipment as required for installation and connection of the miscellaneous medical equipment and systems, including: Psychiatric (mental health) Security Unit Door Signal Systems; Narcotics Storage Signal Systems; and Elapsed Time Indicators.	27 52 41
X4100	Physical Access Control Systems	AR	CC	Equipment as required for fully functioning Physical Access Control System.	28 13 11
A1020	Access Control System and Database Management	AR	CC	Equipment as required for fully functioning Access Control System and Database Management system.	28 13 16
A1026	Security Access Detection	AR	CC	Equipment as required for fully functioning Detection and Screening System, referred to as the Security Access Detection system.	28 13 53
A1023	Intrusion Detection System	AR	CC	Equipment as required for fully functioning Intrusion Detection System, referred to as IDS.	28 16 11
				(continued on next page)	



FMS Active Equipment (FMAE1)

Equipment Guide List (continued)

JSN	NAME	QTY	AI	DESCRIPTION	SPEC
M0436	Video Surveillance System	AR	CC	Equipment as required for fully functioning Video Surveillance System, which is identified as the Closed Circuit Television System, referred to as the CCTV System.	28 23 00
A1025	Electronic Personal Protection System	AR	CC	Equipment as required for fully functioning Duress-Panic Alarms, Emergency Phones/ Call-Boxes, and Intercom Systems, referred to as EPPS System.	28 26 00
A1052	Fire Detection and Alarm System	AR	CC	Equipment as required for fully functioning Fire Detection and Alarm system.	28 31 00
A1010	Telecommunication Outlet	AR	CC	Telecommunication outlet location.	27 15 00
A1014	Telephone, Wall Mounted, 1 Line, With Speaker	1	VV	Telephone, wall mounted, 1 line, with speaker.	
F0610	Desk Folding, W/M	1	CC	Wall mounted fold down desk, approximately 18" H x 23" W x 3" D, with writing surface, pencil-pen rack and multiple form holders.	12 31 00 Or 12 32 00
A0925	Receptacle, Electrical, Quadraplex	AR	CC	Receptacle, quadraplex, 120 V.	26 27 26
A1022	Button, Alarm, Security/Duress	AR	CC	Alarm button, Security/Duress.	27 52 31
				End of Equipment List	



Telephone Equipment Room
Floor Plan

315 NSF
29.3 NSM

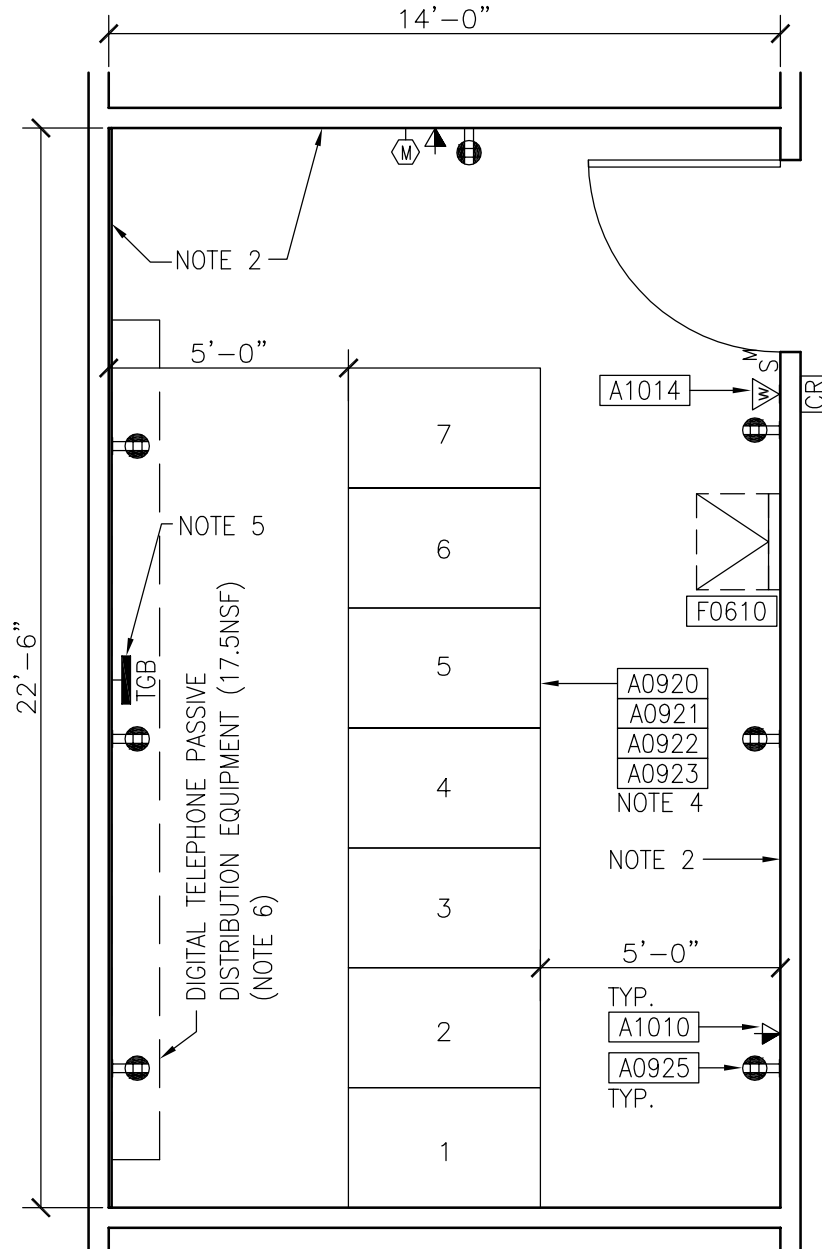

*MINIMUM ROOM SIZE IS 165 NSF. ROOM SHOWN IS BASED ON A FACILITY SIZE OF 300,000 NSF.

SEE DESIGN STANDARDS PAGE OF THIS GUIDE PLATE FOR NUMBERED NOTES.

SEE SECTION 1 FOR SYMBOL LEGEND.

Note: Guide plates are graphical representations of selected room types, illustrating the integration of space, building systems (lights, HVAC, etc), and telecommunications equipment. The Design Team is responsible to perform the calculations to determine final quantities as well as location of each component for every project. Specific infrastructure design requirements are contained in PG 18-5: Equipment Guide List, PG 18-9: Space Planning Criteria, and PG 18-10: Design Manuals (by discipline) located in the VA's Technical Information Library (TIL)
<http://www.cfm.va.gov/TIL/>.

Telephone Equipment Room
Reflected Ceiling Plan

315 NSF
29.3 NSM

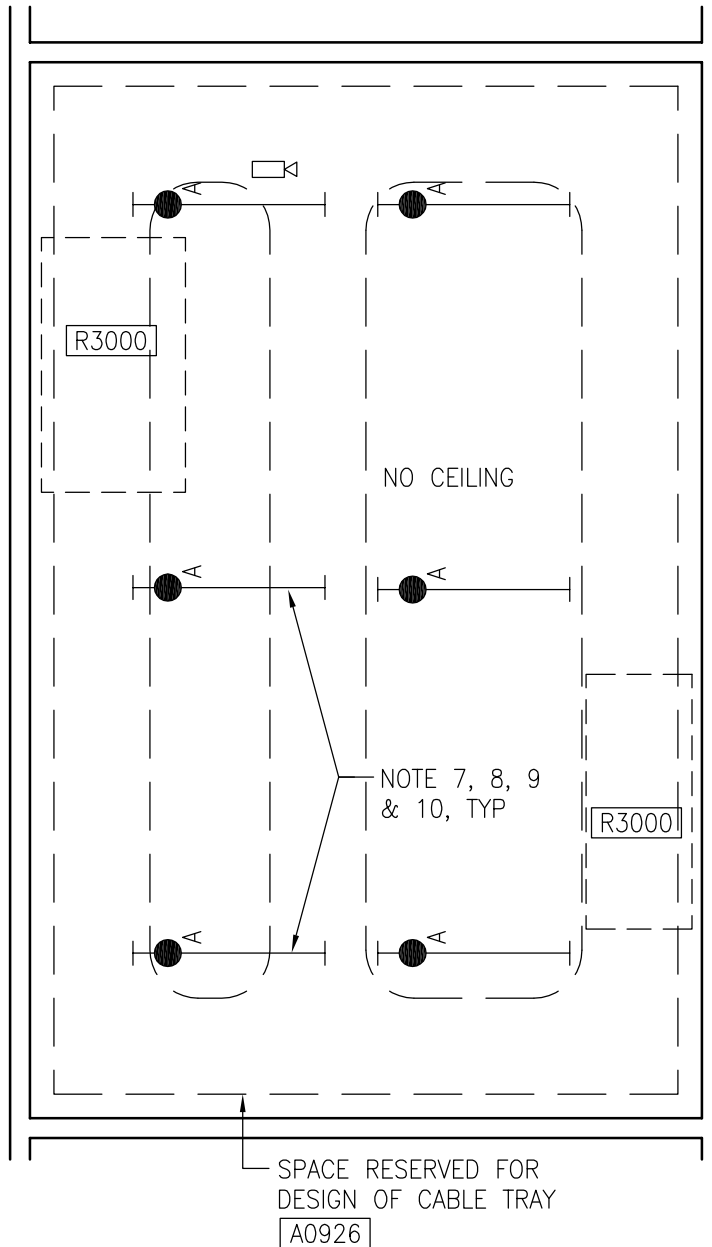

*MINIMUM ROOM SIZE IS 165 NSF. ROOM SHOWN IS BASED ON A FACILITY SIZE OF 300,000 NSF.

SEE DESIGN STANDARDS PAGE OF THIS GUIDE PLATE FOR NUMBERED NOTES.

SEE SECTION 1 FOR SYMBOL LEGEND.

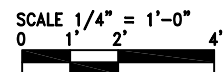

Note: Guide plates are graphical representations of selected room types, illustrating the integration of space, building systems (lights, HVAC, etc), and telecommunications equipment. The Design Team is responsible to perform the calculations to determine final quantities as well as location of each component for every project. Specific infrastructure design requirements are contained in PG 18-5: Equipment Guide List, PG 18-9: Space Planning Criteria, and PG 18-10: Design Manuals (by discipline) located in the VA's Technical Information Library (TIL) <http://www.cfm.va.gov/TIL/>.

Telephone Equipment Room

Design Standards

ARCHITECTURAL

Ceiling:	EXP
Ceiling Height:	--
Wall Finish:	GWB; Notes 1 and 2
Wainscot:	--
Base:	RB
Floor Finish:	SD, Note 3
Slab Depression:	--
Sound Protection:	--
Doors:	Size V (44"W x 84"H); Note 1

Notes:

- 1) Partitions and openings to comply with VA PSDM.
- 2) Painted $\frac{3}{4}$ -inch fire retardant plywood over GWB.
- 3) Static dissipative vinyl tile.

SPECIAL EQUIPMENT

Notes:

- 4) Racks and cabinets are CC. See Equipment List. See *Equipment Modules* page 4-2 for typical rack and cabinet dimensions and clearances,
- 5) Provide Telecommunications Bonding Backbone (EDM 8.3), and conduit connectivity (EDM Table 7-1).
- 6) Space reserved for wall-mounted 110 termination blocks.

LIGHTING

General:	Refer to <u>Electrical Design Manual</u> .
Special:	--

Notes:

- 7) All lighting shall be connected to the Critical Branch of the ESS (EDM 4.6).
- 8) 50 average maintained fc illumination level.
- 9) Suspended three-lamp fluorescent strip lighting fixture with wireguard and F32T8 lamps, 3500°K, CRI=70 (minimum).
- 10) Exact quantity, location, and lamping of fixtures shall be chosen to meet the footcandle requirement.

POWER

General:	Refer to <u>Electrical Design Manual</u> .
Emergency:	Refer to <u>Electrical Design Manual</u> .
Notes:	

- 11) All receptacles and equipment shall be connected to the Critical Branch of the ESS (EDM 4.6).

COMMUNICATION/SPECIAL SYSTEMS

Data:	Yes
Telephone:	Yes
Cable Television:	--
Duress Alarm:	--
Electronic Access and Door Control:	Yes
Intercom:	--
Motion Intrusion Detection (MID):	Yes
Nurse Call, Code One (Blue):	--
Public Address:	--
Security Surveillance Television (SSTV):	Yes
VA Satellite TV:	--
Video Conferencing (VTEL):	--
Notes:	--

HEATING, VENTILATING AND AIR CONDITIONING

Inside Design Conditions:

Indoor design temperature shall be 64-75 degrees F, with relative humidity between 30% and 55%.

Notes:

- 12) Do not run condensate lines or chilled water lines, if provided for room air conditioning unit, above equipment racks or cabinets.

PLUMBING AND MEDICAL GASES

Cold Water:	--
Hot Water:	--
Laboratory Air:	--
Laboratory Vacuum:	--
Sanitary Drain:	--
Reagent Grade Water:	--
Medical Air:	--
Medical Vacuum:	--
Oxygen:	--
Notes:	

- 13) Do not run pipe containing liquids (such as water, drain, or steam) above this space; except as required to provide fire suppression for this space only.

Telephone Equipment Room

Equipment List

JSN	NAME	QTY	AI	DESCRIPTION	SPEC
A0926	Tray, Cable, for Communications Systems	AR	CC	Cable trays for communications systems.	26 05 36
A0921	Rack, Equipment, Freestanding, Steel	AR	CC	Equipment rack, freestanding, steel.	27 31 00
A0923	Wire Management System	AR	CC	Wire management system.	27 31 00
A0920	Cross Connection System (CCS)	AR	CC	Equipment breakout, Termination Connector (or bulkhead), and patch Panels.	27 11 00
A0922	Voice Communication Switching and Routing Equipment	AR	CC	Voice Communications Switching And Routing Equipment.	27 31 00
A1010	Telecommunication Outlet	7	CC	Telecommunication outlet location.	27 15 00
A1014	Telephone, Wall Mounted, 1 Line, With Speaker	1	VV	Telephone, wall mounted, 1 line, with speaker.	
F0610	Desk, Folding W/M	1	CC	Wall mounted fold down desk, approximately 18" H x 23" W X 3" D. with writing surface, pencil-pen rack and multiple form holders.	12 31 00 Or 12 32 00
A0925	Receptacle, Electrical, Quadraplex	7	CC	Receptacle, quadraplex, 120 V.	26 27 26
R3000	Air Conditioner, Computer Room, Wall or Ceiling Mounted (ceiling mounted shown)	AR	CC	Process cooling, split system or chilled water, air conditioning unit designed for computer room use. Unit shall be packaged, factory assembled, prewired, and pre-piped; consisting of cabinet, fans, filters, humidifier, and controls. Condensing unit may be remote, air cooled; or integral water cooled type.	23 81 23
				End of Equipment Guide List	



Network Operations Room (ITNT1)

120 NSF

Floor Plan

11.2 NSM

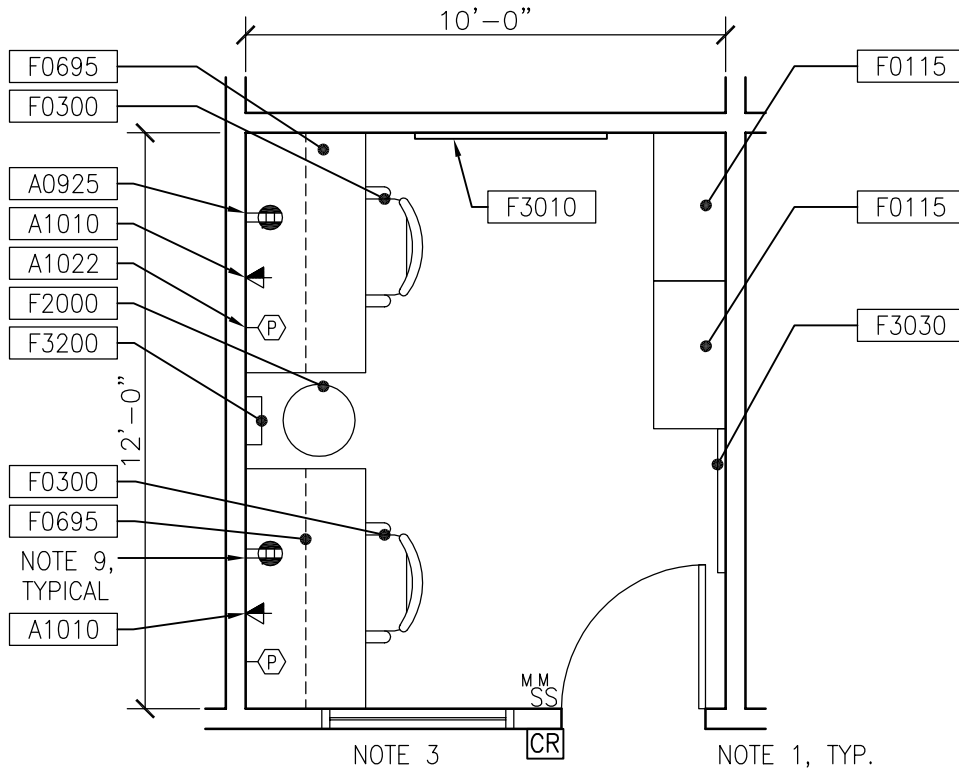

SEE DESIGN STANDARDS PAGE OF THIS GUIDE PLATE FOR NUMBERED NOTES.

SEE SECTION 1 FOR SYMBOL LEGEND.

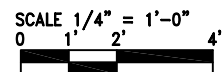

Note: Guide plates are graphical representations of selected room types, illustrating the integration of space, building systems (lights, HVAC, etc), and telecommunications equipment. The Design Team is responsible to perform the calculations to determine final quantities as well as location of each component for every project. Specific infrastructure design requirements are contained in PG 18-5: Equipment Guide List, PG 18-9: Space Planning Criteria, and PG 18-10: Design Manuals (by discipline) located in the VA's Technical Information Library (TIL)
<http://www.cfm.va.gov/TIL/>.

Network Operations Room (ITNT)

120 NSF

Reflected Ceiling Plan

11.2 NSM

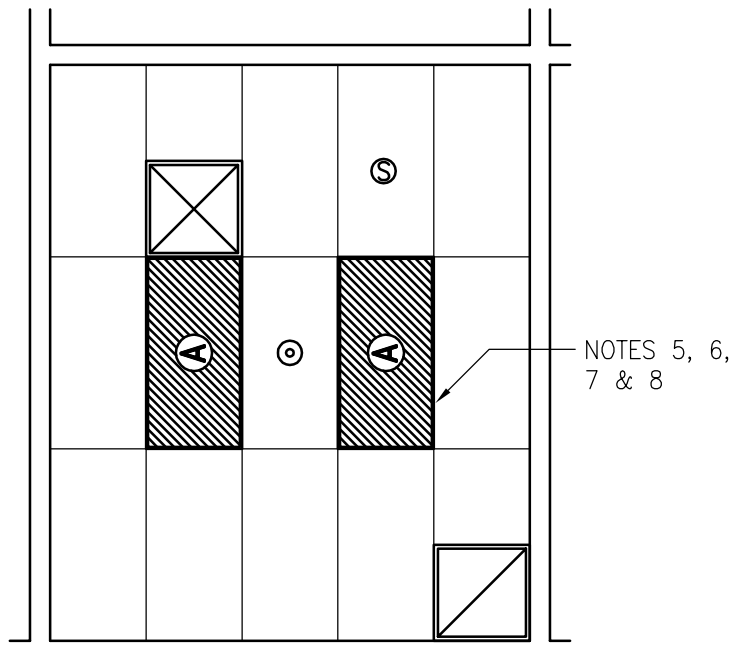

SEE DESIGN STANDARDS PAGE OF THIS GUIDE PLATE FOR NUMBERED NOTES.

SEE SECTION 1 FOR SYMBOL LEGEND.

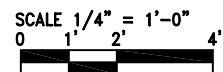

Note: Guide plates are graphical representations of selected room types, illustrating the integration of space, building systems (lights, HVAC, etc), and telecommunications equipment. The Design Team is responsible to perform the calculations to determine final quantities as well as location of each component for every project. Specific infrastructure design requirements are contained in PG 18-5: Equipment Guide List, PG 18-9: Space Planning Criteria, and PG 18-10: Design Manuals (by discipline) located in the VA's Technical Information Library (TIL) <http://www.cfm.va.gov/TIL/>.

Network Operations Room (ITNT1)

Design Standards

ARCHITECTURAL

Ceiling:	AT
Ceiling Height:	9'-0"
Wall Finish:	GWB-P; Note 1
Wainscot:	--
Base:	RB
Floor Finish:	SD; Note 2
Slab Depression:	Note 4
Sound Protection:	--
Doors:	Size S (36"W x 84"H); Note 1

Notes:

- 1) Partitions and openings to comply with VA PSDM.
- 2) Static dissipative vinyl tile.
- 3) Borrowed light; 6mm tempered glass; 48-inches wide by 42-inches high.
- 4) If this room is designed as "soft space" to allow for expansion of the Main Computer Room, depress floor and provide access floor system to match the MCR.

SPECIAL EQUIPMENT

Notes: --

LIGHTING

General: Refer to [Electrical Design Manual](#)

Special: --

Notes: --

- 5) All lighting shall be connected to the Critical Branch of the ESS (EDM 4.6).
- 6) 50 average maintained fc illumination level.
- 7) Recessed three-lamp fluorescent lighting fixture with acrylic lens and F32T8 lamps, 3500°K, CRI=70 (minimum), dual-level occupancy-sensor switched. Switch inner lamps on the first switch and outer lamps on the second switch.
- 8) Exact quantity, location, and lamping of fixtures shall be chosen to meet the footcandle requirement.

POWER

General: Refer to [Electrical Design Manual](#)

Emergency: Refer to [Electrical Design Manual](#)

Notes:

- 9) All receptacles and equipment shall be connected to UPS power (EDM 5.3), and the UPS equipment connected to the Critical Branch of the ESS (EDM 4.6).

COMMUNICATION/SPECIAL SYSTEMS

Data: Yes

Telephone: Yes

Cable Television: --

Duress Alarm: Yes

Electronic Access and Door Control: Yes

Intercom: --

Motion Intrusion Detection (MID): --

Nurse Call, Code One (Blue): --

Public Address: Yes

Security Surveillance Television (SSTV): --

VA Satellite TV: --

Video Teleconferencing (VTEL): --

Notes: --

HEATING, VENTILATING AND AIR CONDITIONING

Inside Design Conditions:

Refer to [HVAC Design Manual](#).

Notes:

- 10) This space may be served by the same dedicated HVAC equipment as the Main Computer Room.

PLUMBING AND MEDICAL GASES

Cold Water: --

Hot Water: --

Laboratory Air: --

Laboratory Vacuum: --

Sanitary Drain: --

Reagent Grade Water: --

Medical Air: --

Medical Vacuum: --

Oxygen: --

Notes:

- 11) Do not run pipe containing liquids (such as water, drain, or steam) above this space; except as required to provide fire suppression for this space only.

Network Operations Room (ITNT1)

Equipment Guide List

JSN	NAME	QTY	AI	DESCRIPTION	SPEC
A1010	Telecommunication Outlet	2	CC	Telecommunication outlet location.	27 15 00
A1011	Telephone, Desk, 1 Line	2	VV	Telephone, desk, 1 line.	
F0115	Bookcase, Open, 5 Shelf	2	VV	Freestanding open shelf bookcase, approximately 82" H x 37" W x 18" D with 5 (five) adjustable shelves. Unit can be separate or part of a system with available add-on shelving.	
F0300	Chair, Task, Swivel	2	VV	Task chair, approximately 34" H x 26" W x 22" D with adjustable arms and a five caster adjustable swivel base. Seat and back are foam padded and upholstered in woven fabric or vinyl.	
F0695	Workstation, Computer, Open	2	VV	Computer operator workstation, 55" H x 60" W x 27" D with large work surface and one (1) 17" H x 48" W x 16" D hutch. Desk has one (1) pull-out keyboard shelf. Hutch has adjustable open shelves.	
F2000	Basket, Wastepaper, Round Metal	1	VV	Approximately 18" H x 16" diameter. This metal unit is used to collect and temporarily store small quantities of paper refuse in patient rooms, administrative areas and nursing stations.	
F3010	Board, Bulletin, 48 x 48	1	CC	Open face bulletin board. Cork posting panel with moisture proof backing. Variety of frames to choose from. Used for posting notes and messages.	10 11 23
F3030	Board, Scheduling, Magnetic	1	CC	Magnetic scheduling board, 36" W x 48" H. Porcelain enamel magnetic surface. Used for letter transferring while posting messages or scheduling. For use with marker pens.	10 11 13
F3200	Clock, Battery, 12" Diameter	1	VV	Round surface, easy to read numbers with sweep second hand. Wall mounted unit for use when impractical to install a fully synchronized clock system. Battery operated, (batteries not included).	
M1801	Computer, Microprocessing, w/ Flat Panel Monitor	2	VV	Desk top microprocessing computer. The unit shall consist of a central processing mini tower, flat panel monitor, keyboard, mouse and speakers. The computer is used throughout the facility to input, manipulate and retrieve information.	
A0925	Receptacle, Electrical, Quadraplex	2	CC	Receptacle, quadraplex, 120 V.	26 27 26
A1022	Button, Alarm, Security/Duress	2	CC	Alarm button, Security/Duress.	27 52 31
				End of Equipment Guide List	

Storage, Active Data (ITAD1)

100 NSF

Floor Plan

9.3 NSM

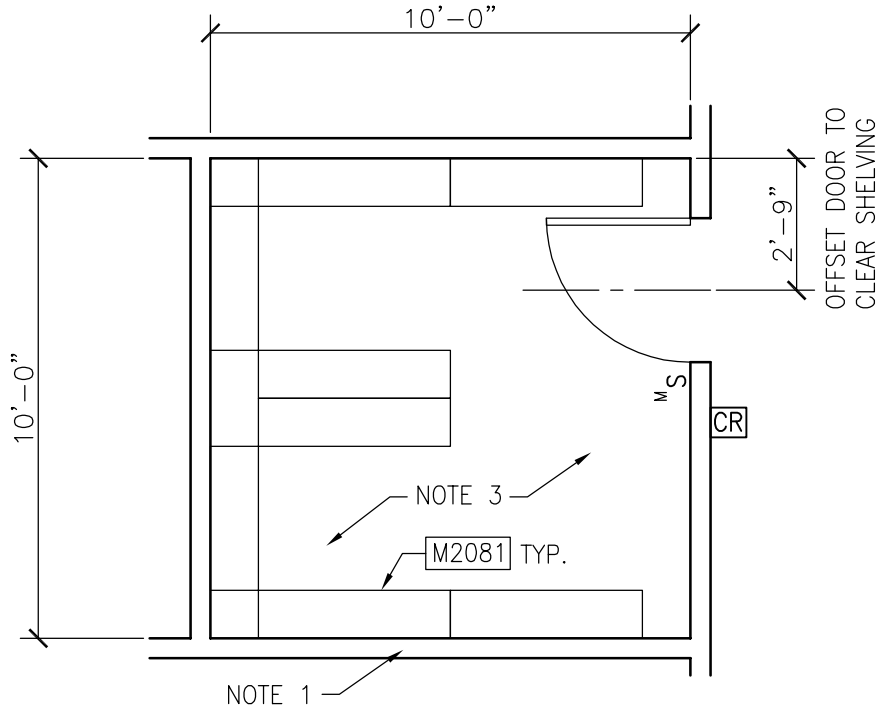

SEE DESIGN STANDARDS PAGE OF THIS GUIDE PLATE FOR NUMBERED NOTES.

SEE SECTION 1 FOR SYMBOL LEGEND.

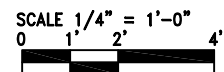

Note: Guide plates are graphical representations of selected room types, illustrating the integration of space, building systems (lights, HVAC, etc), and telecommunications equipment. The Design Team is responsible to perform the calculations to determine final quantities as well as location of each component for every project. Specific infrastructure design requirements are contained in PG 18-5: Equipment Guide List, PG 18-9: Space Planning Criteria, and PG 18-10: Design Manuals (by discipline) located in the VA's Technical Information Library (TIL) <http://www.cfm.va.gov/TIL/>.

Storage, Active Data (ITAD1)

100 NSF

Reflected Ceiling Plan

9.3 NSM

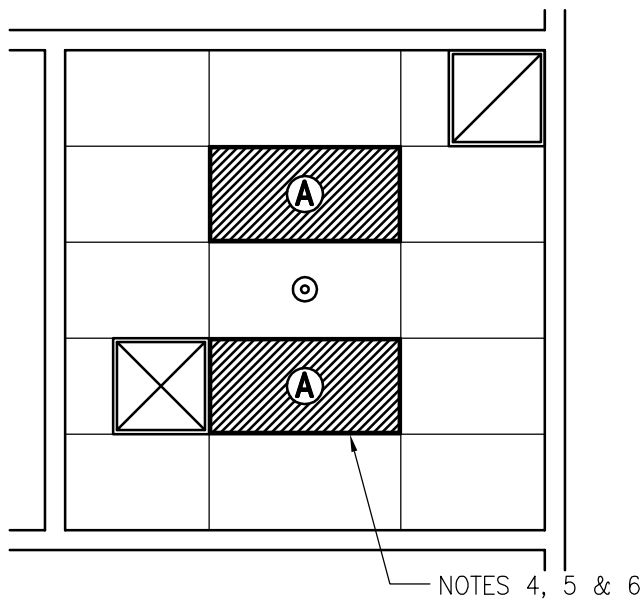

SEE DESIGN STANDARDS PAGE OF THIS GUIDE PLATE FOR NUMBERED NOTES.

SEE SECTION 1 FOR SYMBOL LEGEND.

Note: Guide plates are graphical representations of selected room types, illustrating the integration of space, building systems (lights, HVAC, etc), and telecommunications equipment. The Design Team is responsible to perform the calculations to determine final quantities as well as location of each component for every project. Specific infrastructure design requirements are contained in PG 18-5: Equipment Guide List, PG 18-9: Space Planning Criteria, and PG 18-10: Design Manuals (by discipline) located in the VA's Technical Information Library (TIL)
<http://www.cfm.va.gov/TIL/>.

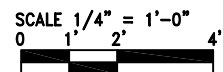

Storage, Active Data (ITAD1)

Design Standards

ARCHITECTURAL

Ceiling:	AT
Ceiling Height:	9'-0"
Wall Finish:	GWB-P, Note 1
Wainscot:	--
Base:	RB
Floor Finish:	SD, Note 2
Slab Depression:	--
Sound Protection:	--
Doors:	Size S (36"W x 84"H); Note 1

Notes:

- 1) Partitions & opening to comply with VA PSDM.
- 2) Static dissipative vinyl tile.
- 3) If this room is designed as "soft space" to allow for expansion of the Main Computer Room, depress floor and provide access floor system to match the MCR.

SPECIAL EQUIPMENT

Notes: --

LIGHTING

General: Refer to Electrical Design Manual.

Special: --

Notes:

- 4) 30 average maintained fc illumination level.
- 5) Recessed two-lamp fluorescent lighting fixture with acrylic lens and F32T8 lamps, 3500°K, CRI=70 (minimum), occupancy-sensor switched.
- 6) Exact quantity, location, and lamping of fixtures shall be chosen to meet the footcandle requirement.

POWER

General: Refer to Electrical Design Manual.

Emergency: Refer to Electrical Design Manual.

Notes: --

COMMUNICATION/SPECIAL SYSTEMS

Data:	--
Telephone:	--
Cable Television:	--
Duress Alarm:	--
Electronic Access and Door Control:	Yes
Intercom:	--
Motion Intrusion Detection (MID):	--
Nurse Call, Code One (Blue):	--
Public Address:	--
Security Surveillance Television (SSTV):	--
VA Satellite TV:	--
Video Conferencing (VTEL):	--
Notes:	--

HEATING, VENTILATING AND AIR CONDITIONING

Inside Design Conditions:

Refer to HVAC Design Manual.

Notes:

- 7) This space may be served by the same dedicated HVAC equipment as the Main Computer Room.

PLUMBING AND MEDICAL GASES

Cold Water:	--
Hot Water:	--
Laboratory Air:	--
Laboratory Vacuum:	--
Sanitary Drain:	--
Reagent Grade Water:	--
Medical Air:	--
Medical Vacuum:	--
Oxygen:	--

Notes:

- 8) Do not run pipe containing liquids (such as water, drain, or steam) above this space; except as required to provide fire suppression for this space only.



Storage, Active Data (ITAD1)

Equipment Guide List

JSN	NAME	QTY	AI	DESCRIPTION	SPEC
M2081	Shelving, Storage, 75"H x 36"W x 12"D	10	VV	Storage shelving unit, baked enamel on steel, 5 adjustable shelves. 400 pound load capacity. Available in open or closed (end panels) designs. Unit is designed for storage and light industrial applications.	
				End of Equipment List	

Receiving / Breakdown Room (ITBD1)

240 NSF

Floor Plan

22.3 NSM

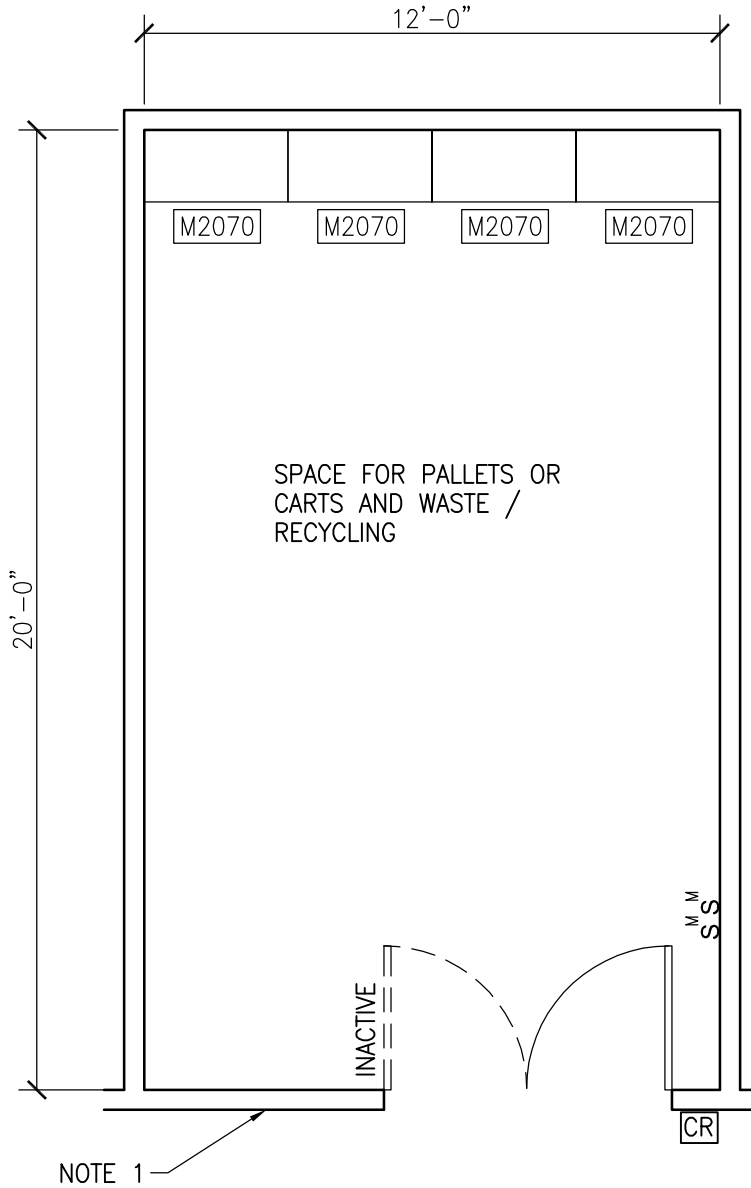

SEE DESIGN STANDARDS PAGE OF THIS GUIDE PLATE FOR NUMBERED NOTES.

SEE SECTION 1 FOR SYMBOL LEGEND.

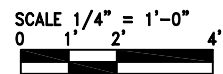

Note: Guide plates are graphical representations of selected room types, illustrating the integration of space, building systems (lights, HVAC, etc), and telecommunications equipment. The Design Team is responsible to perform the calculations to determine final quantities as well as location of each component for every project. Specific infrastructure design requirements are contained in PG 18-5: Equipment Guide List, PG 18-9: Space Planning Criteria, and PG 18-10: Design Manuals (by discipline) located in the VA's Technical Information Library (TIL) <http://www.cfm.va.gov/TIL/>.

Receiving / Breakdown Room (ITBD1)

240 NSF

Reflected Ceiling Plan

22.3 NSM

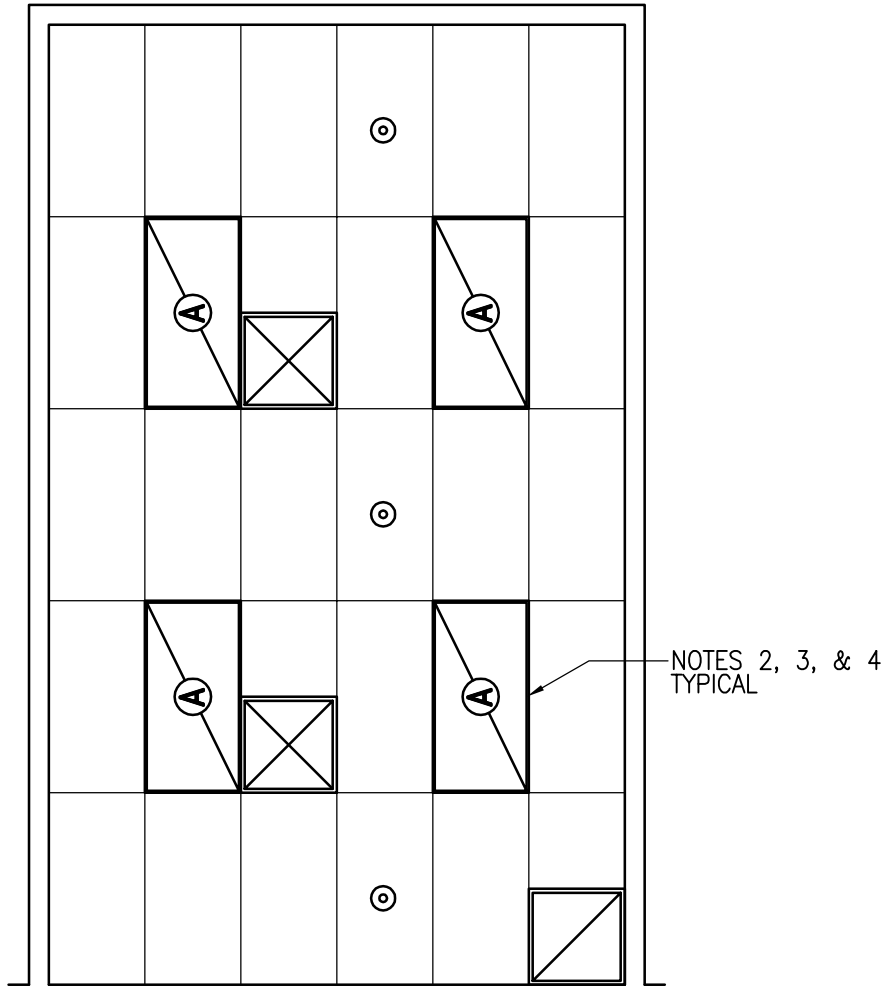

NOTE 1

SEE DESIGN STANDARDS PAGE OF THIS GUIDE PLATE FOR NUMBERED NOTES.

SEE SECTION 1 FOR SYMBOL LEGEND.

Note: Guide plates are graphical representations of selected room types, illustrating the integration of space, building systems (lights, HVAC, etc), and telecommunications equipment. The Design Team is responsible to perform the calculations to determine final quantities as well as location of each component for every project. Specific infrastructure design requirements are contained in PG 18-5: Equipment Guide List, PG 18-9: Space Planning Criteria, and PG 18-10: Design Manuals (by discipline) located in the VA's Technical Information Library (TIL)

<http://www.cfm.va.gov/TIL/>.

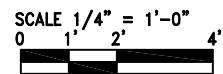

Receiving / Breakdown Room (ITBD1)

Design Standards

ARCHITECTURAL

Ceiling:	AT
Ceiling Height:	9'-0"
Wall Finish:	GWB-P; Note 1
Wainscot:	--
Base:	RB
Floor Finish:	RES-1
Slab Depression:	--
Sound Protection:	--
Doors:	Pair, Size SS (36"W x 84"H each leaf)
Notes:	--
	1) Partitions and openings to comply with VA PSDM.

SPECIAL EQUIPMENT

Notes: --

LIGHTING

General:	Refer to <u>Electrical Design Manual</u> .
Special:	--
Notes:	--
	2) 50 average maintained fc illumination level.
	3) Recessed three-lamp fluorescent lighting fixture with acrylic lens and F32T8 lamps, 3500°K, CRI=70 (minimum), dual-level occupancy-sensor switched. Switch inner lamps on the first switch and outer lamps on the second switch.
	4) Exact quantity, location, and lamping of fixtures shall be chosen to meet the footcandle requirement.

POWER

General:	Refer to <u>Electrical Design Manual</u> .
Emergency:	--
Notes:	--

COMMUNICATION/SPECIAL SYSTEMS

Data:	--
Telephone:	--
Cable Television:	--
Duress Alarm:	--
Electronic Access and Door Control:	Yes
Intercom:	--
Motion Intrusion Detection (MID):	--
Nurse Call, Code One (Blue):	--
Public Address:	--
Security Surveillance Television (SSTV):	--
VA Satellite TV:	--
Video Conferencing (VTEL):	--
Notes:	--

HEATING, VENTILATING AND AIR CONDITIONING

Inside Design Conditions:	--
	Refer to <u>HVAC Design Manual</u> .
Notes:	--

PLUMBING AND MEDICAL GASES

Cold Water:	--
Hot Water:	--
Laboratory Air:	--
Laboratory Vacuum:	--
Sanitary Drain:	--
Reagent Grade Water:	--
Medical Air:	--
Medical Vacuum:	--
Oxygen:	--
Notes:	--

Receiving / Breakdown Room (ITBD1)

Equipment List

JSN	NAME	QTY	AI	DESCRIPTION	SPEC
M2070	Shelving, Storage 77"H x 36"W x 18"D	4	VV	Storage shelving unit. Corrosion resistant baked enamel. Open unit with adjustable shelves. The closed version is also available. For use in the storage room.	
				End of Equipment List	



Workroom, Eq. Configuration / Repair (ITWR1)

200 NSF

Floor Plan

18.6 NSM

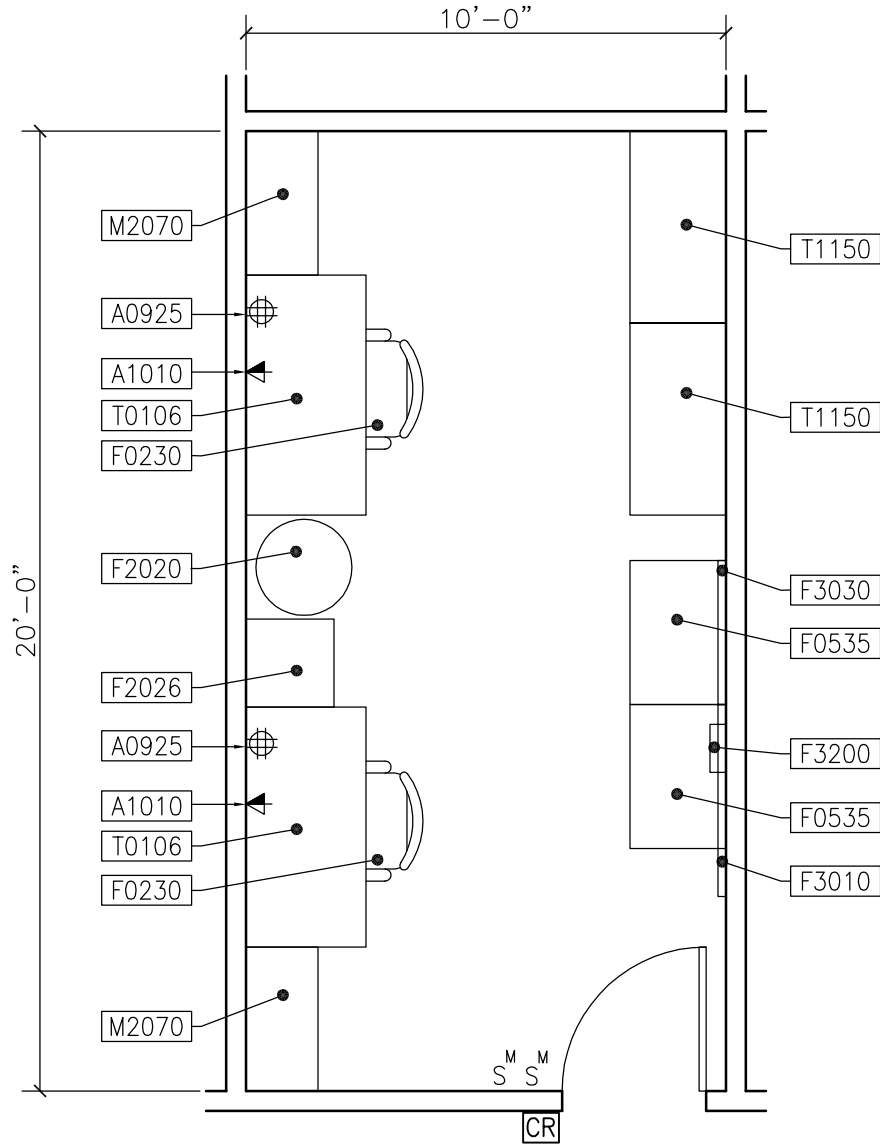

SEE DESIGN STANDARDS PAGE OF THIS GUIDE PLATE FOR NUMBERED NOTES.

SEE SECTION 1 FOR SYMBOL LEGEND.

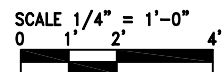

Note: Guide plates are graphical representations of selected room types, illustrating the integration of space, building systems (lights, HVAC, etc), and telecommunications equipment. The Design Team is responsible to perform the calculations to determine final quantities as well as location of each component for every project. Specific infrastructure design requirements are contained in PG 18-5: Equipment Guide List, PG 18-9: Space Planning Criteria, and PG 18-10: Design Manuals (by discipline) located in the VA's Technical Information Library (TIL)

<http://www.cfm.va.gov/TIL/>

Workroom, Eq. Configuration / Repair (ITWR1)
Reflected Ceiling Plan

200 NSF
18.6 NSM

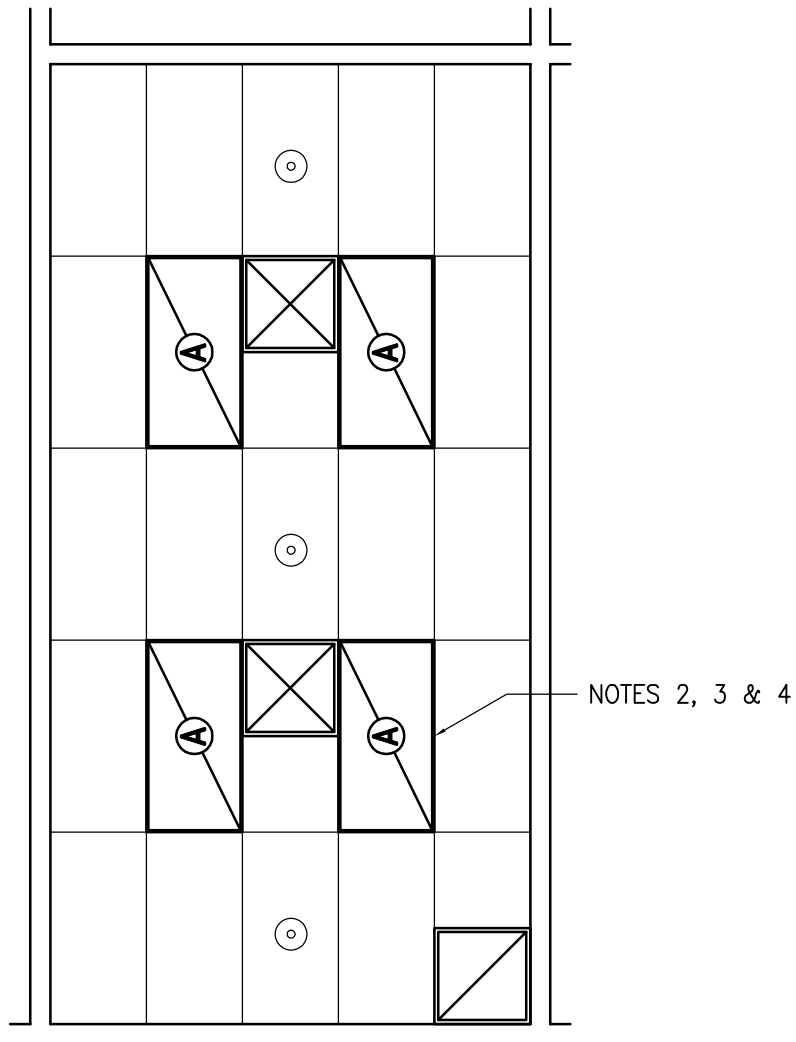

SEE DESIGN STANDARDS PAGE OF THIS GUIDE PLATE FOR NUMBERED NOTES.

SEE SECTION 1 FOR SYMBOL LEGEND.

Note: Guide plates are graphical representations of selected room types, illustrating the integration of space, building systems (lights, HVAC, etc), and telecommunications equipment. The Design Team is responsible to perform the calculations to determine final quantities as well as location of each component for every project. Specific infrastructure design requirements are contained in PG 18-5: Equipment Guide List, PG 18-9: Space Planning Criteria, and PG 18-10: Design Manuals (by discipline) located in the VA's Technical Information Library (TIL)
<http://www.cfm.va.gov/TIL/>.

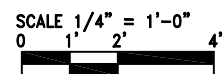

Workroom, Equipment Configuration / Repair (ITWR1)

Design Standards

ARCHITECTURAL

Ceiling:	AT
Ceiling Height:	9'-0"
Wall Finish:	GWB-P
Wainscot:	--
Base:	RB
Floor Finish:	SD: Note 1
Slab Depression:	--
Sound Protection:	--
Doors:	Size S (36"W x 84"H)
Notes:	--
	1) Static dissipative vinyl tile.

SPECIAL EQUIPMENT

Notes: --

LIGHTING

General:	Refer to Electrical Design Manual
Special:	--
Notes:	--
	2) 70 average maintained fc illumination level.
	3) Recessed three-lamp fluorescent lighting fixture with acrylic lens and F32T8 lamps, 3500°K, CRI=70 (minimum), dual-level occupancy-sensor switched. Switch inner lamps on the first switch and outer lamps on the second switch.
	4) Exact quantity, location, and lamping of fixtures shall be chosen to meet the footcandle requirement.

POWER

General:	Refer to Electrical Design Manual
Emergency:	Refer to Electrical Design Manual
Notes:	--

COMMUNICATION/SPECIAL SYSTEMS

Data:	Yes
Telephone:	Yes
Cable Television:	--
Duress Alarm:	--
Electronic Access and Door Control:	Yes
Intercom:	--
Motion Intrusion Detection (MID):	--
Nurse Call, Code One (Blue):	--
Public Address:	--
Security Surveillance Television (SSTV)	--
VA Satellite TV:	--
Video Teleconferencing (VTEL):	--
Notes:	--

HEATING, VENTILATING AND AIR CONDITIONING

Inside Design Conditions:	Refer to HVAC Design Manual .
Notes:	--

PLUMBING AND MEDICAL GASES

Cold Water:	--
Hot Water:	--
Laboratory Air:	--
Laboratory Vacuum:	--
Sanitary Drain:	--
Reagent Grade Water:	--
Medical Air:	--
Medical Vacuum:	--
Oxygen:	--
Notes:	--

Workroom, Equipment Configuration / Repair (ITWR1)

Equipment Guide List

JSN	NAME	QTY	AI	DESCRIPTION	SPEC
A1010	Telecommunication Outlet	2	CC	Telecommunication outlet location.	27 15 00
A1016	Telephone, Desk, With Speaker	2	VV	Telephone, desk, with speaker.	
F0230	Chair, Drafting, Rotary	2	VV	Drafting chair approximately 47" H x 20" W x 20" D with rotary stool and a 5 (five) star base with casters. Padded seat and back. Foot ring adjusts with chair.	
T0106	Bench, Work, with 4 Drawers, 1 Cabinet, 2 Shelves.	2	VV	Workbench with 4 drawers approximately 38" H x 60" W x 30" D. Characteristics/components include heavy gauge steel construction, four drawers, each approximately 14 3/4" W x 19 1/2" D x 5 5/8" H, on nylon rollers; each drawer includes a provision for cylinder lock and pull, and a single full size door with lock and shelf.	
F2020	Can, Trash, 44 Gallon	1	VV	Forty four (44) gallon trash can, 32" H x 24" diameter, with lid. Used to collect and transport refuse from a point of origin to point of disposal.	
F2026	Container, Recycling, Large	1	VV	Recycling container shall be approximately 30-gallons in capacity (32" H x 22" W x 22" D). The container may include a lid and be Recycle Blue in color with the recycle symbol identified on the container.	
F3010	Board, Bulletin, 48 x 48	1	CC	Board, Bulletin, 48 x 48Open face bulletin board. Cork posting panel with moisture proof backing. Variety of frames to choose from. Used for posting notes and messages.	10 11 23
F3030	Board, Scheduling, Magnetic	1	CC	Magnetic scheduling board, 36" W x 48" H. Porcelain enamel magnetic surface. Used for letter transferring while posting messages or scheduling. For use with marker pens.	10 11 13
F3200	Clock, Battery, 12" Diameter	1	VV	Round surface, easy to read numbers with sweep second hand. Wall mounted unit for use when impractical to install a fully synchronized clock system. Battery operated, (batteries not included).	
M1801	Computer, Microprocessing, w/ Flat Panel Monitor	2	VV	Desk top microprocessing computer. The unit shall consist of a central processing mini tower, flat panel monitor, keyboard, mouse and speakers. The computer is used throughout the facility to input, manipulate and retrieve information.	
				(continued on next page)	

Workroom, Equipment Configuration / Repair (ITWR1)

Equipment Guide List (continued)

JSN	NAME	QTY	AI	DESCRIPTION	SPEC
M2070	Shelving, Storage, 77H x 36W x 18D	2	VV	Storage shelving unit. Corrosion resistant baked enamel. Open unit with adjustable shelves. The closed version is also available. For use in the storage room	
T1150	Cabinet, Storage, Electric Parts	2	VV	Electric parts storage cabinet approximately 82" H x 48" W x 24" D. Characteristics/components include sturdy construction steel hardware; provides storage space for various items; adjustable dividers in drawers; double doors; and master-keyed lock. This cabinet can be used to store electric parts in an electrical shop.	
F0535	Cart, Service	2	VV	Approximately 32" H x 24" W x 36" D. Characteristics/components include: sturdy steel construction with two 3" deep open trays, tubular steel handles, 5" diameter casters (two swivel, two fixed), corrosion resistant baked enamel finish; 400 pound capacity; for general purpose use in stockrooms, shipping and receiving, and workshops.	
A0925	Receptacle, Electrical, Quadraplex	4	CC	Receptacle, quadraplex, 120 V.	26 27 26
				End of Equipment List	

For space for each additional FTE, provide the following:

JSN	NAME	QTY	AI	DESCRIPTION	SPEC
A1010	Telecommunication Outlet	1	CC	Telecommunication outlet location.	27 15 00
A1016	Telephone, Desk, With Speaker	1	VV	Telephone, desk, with speaker.	
F0230	Chair, Drafting, Rotary	1	VV	Drafting chair approximately 47" H x 20" W x 20" D.	
T0106	Bench, Work, with 4 Drawers, 1 Cabinet, 2 Shelves.	1	VV	Workbench with 4 drawers approximately 38" H x 60" W x 30" D	
M2070	Shelving, Storage, 77H x 36W x 18D	1	VV	Storage shelving unit.	
T1150	Cabinet, Storage, Electric Parts	1	VV	Electric parts storage cabinet approximately 82" H x 48" W x 24" D.	
F0535	Cart, Service	1	VV	Approximately 32" H x 24" W x 36" D.	
A0925	Receptacle, Electrical, Quadraplex	1	CC	Receptacle, quadraplex, 120 V.	26 27 26
				End of Equipment List	

This page intentionally left blank.

Storage, Temporary Data (ITRD1)

120 NSF

Floor Plan

11.2 NSM

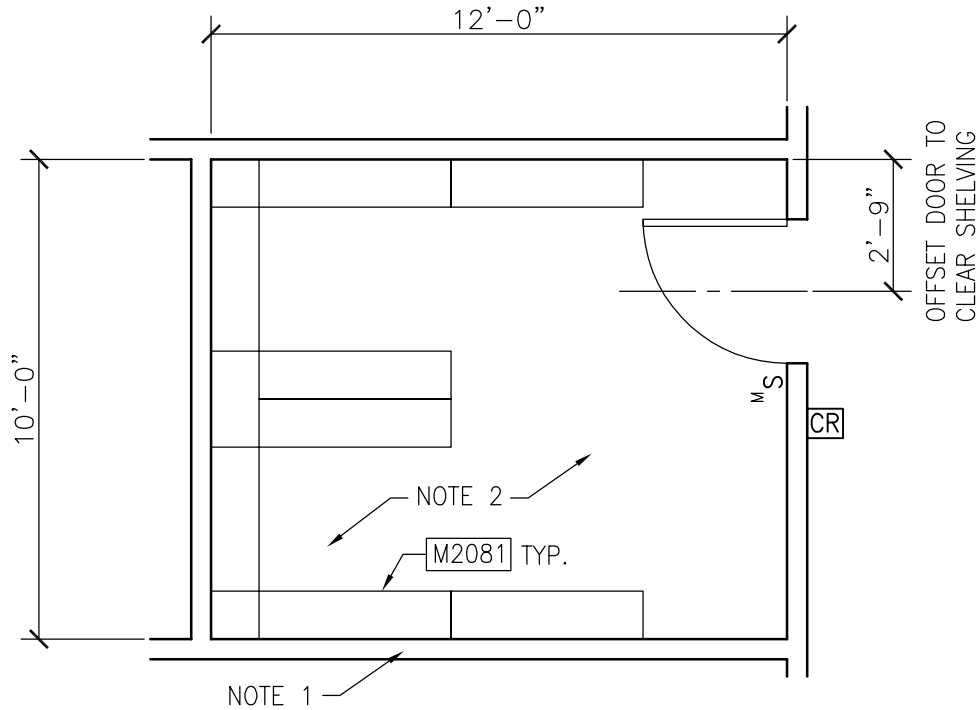

SEE DESIGN STANDARDS PAGE OF THIS GUIDE PLATE FOR NUMBERED NOTES.

SEE SECTION 1 FOR SYMBOL LEGEND.

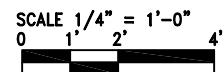

Note: Guide plates are graphical representations of selected room types, illustrating the integration of space, building systems (lights, HVAC, etc), and telecommunications equipment. The Design Team is responsible to perform the calculations to determine final quantities as well as location of each component for every project. Specific infrastructure design requirements are contained in PG 18-5: Equipment Guide List, PG 18-9: Space Planning Criteria, and PG 18-10: Design Manuals (by discipline) located in the VA's Technical Information Library (TIL) <http://www.cfm.va.gov/TIL/>.

Storage, Temporary Data (ITRD1)

120 NSF

Reflected Ceiling Plan

11.2 NSM

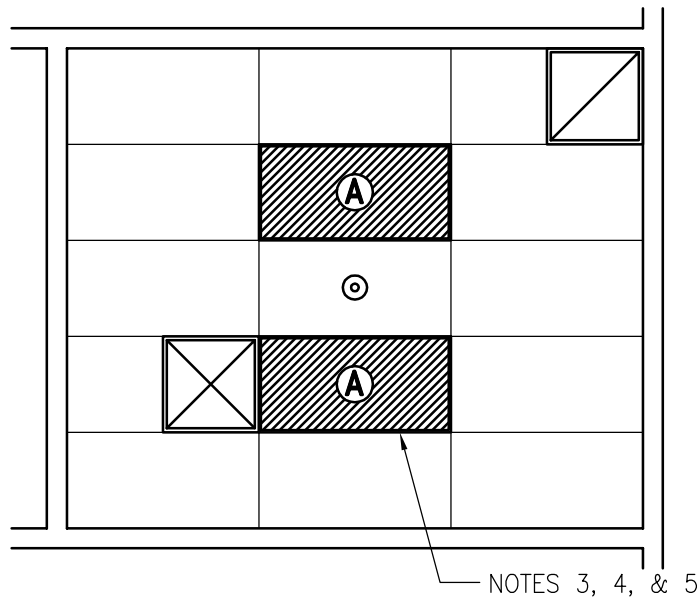

SEE DESIGN STANDARDS PAGE OF THIS GUIDE PLATE FOR NUMBERED NOTES.
 SEE SECTION 1 FOR SYMBOL LEGEND.

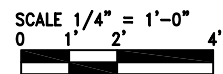

Note: Guide plates are graphical representations of selected room types, illustrating the integration of space, building systems (lights, HVAC, etc), and telecommunications equipment. The Design Team is responsible to perform the calculations to determine final quantities as well as location of each component for every project. Specific infrastructure design requirements are contained in PG 18-5: Equipment Guide List, PG 18-9: Space Planning Criteria, and PG 18-10: Design Manuals (by discipline) located in the VA's Technical Information Library (TIL)
<http://www.cfm.va.gov/TIL/>.

Storage, Temporary Data (ITRD1)

Design Standards

ARCHITECTURAL

Ceiling:	AT
Ceiling Height:	9'-0"
Wall Finish:	GWB-P, Note 1
Wainscot:	--
Base:	RB
Floor Finish:	SD, Note 2
Slab Depression:	--
Sound Protection:	--
Doors:	Size S (36"W x 84"H); Note 1
Notes:	
1)	Partitions & opening to comply with VA PSDM.
2)	Static dissipative vinyl tile.

SPECIAL EQUIPMENT

Notes: --

LIGHTING

General:	Refer to <u>Electrical Design Manual</u> .
Special:	--
Notes:	
3)	30 average maintained fc illumination level.
4)	Recessed two-lamp fluorescent lighting fixture with acrylic lens and F32T8 lamps, 3500°K, CRI=70 (minimum), occupancy-sensor switched.
5)	Exact quantity, location, and lamping of fixtures shall be chosen to meet the footcandle requirement.

POWER

General:	Refer to <u>Electrical Design Manual</u> .
Emergency:	Refer to <u>Electrical Design Manual</u> .
Notes:	--

COMMUNICATION/SPECIAL SYSTEMS

Data:	--
Telephone:	--
Cable Television:	--
Duress Alarm:	--
Electronic Access and Door Control:	Yes
Intercom:	--
Motion Intrusion Detection (MID):	--
Nurse Call, Code One (Blue):	--
Public Address:	--
Security Surveillance Television (SSTV)	--
VA Satellite TV:	--
Video Conferencing (VTEL):	--
Notes:	--

HEATING, VENTILATING AND AIR CONDITIONING

Inside Design Conditions:
Refer to HVAC Design Manual.

Notes:

PLUMBING AND MEDICAL GASES

Cold Water:	--
Hot Water:	--
Laboratory Air:	--
Laboratory Vacuum:	--
Sanitary Drain:	--
Reagent Grade Water:	--
Medical Air:	--
Medical Vacuum:	--
Oxygen:	--
Notes:	

- Do not run pipe containing liquids (such as water, drain, or steam) above this space; except as required to provide fire suppression for this space only.

Storage, Temporary Data (ITRD1)

Equipment Guide List

JSN	NAME	QTY	AI	DESCRIPTION	SPEC
M2081	Shelving, Storage, 75"H x 36"W x 12"D	10	VV	Storage shelving unit, baked enamel on steel, 5 adjustable shelves. 400 pound load capacity. Available in open or closed (end panels) designs. Unit is designed for storage and light industrial applications.	
				End of Equipment List	



Antenna Headend Equipment Room (TEEQ1)

300 NSF*

Floor Plan

27.9 NSM

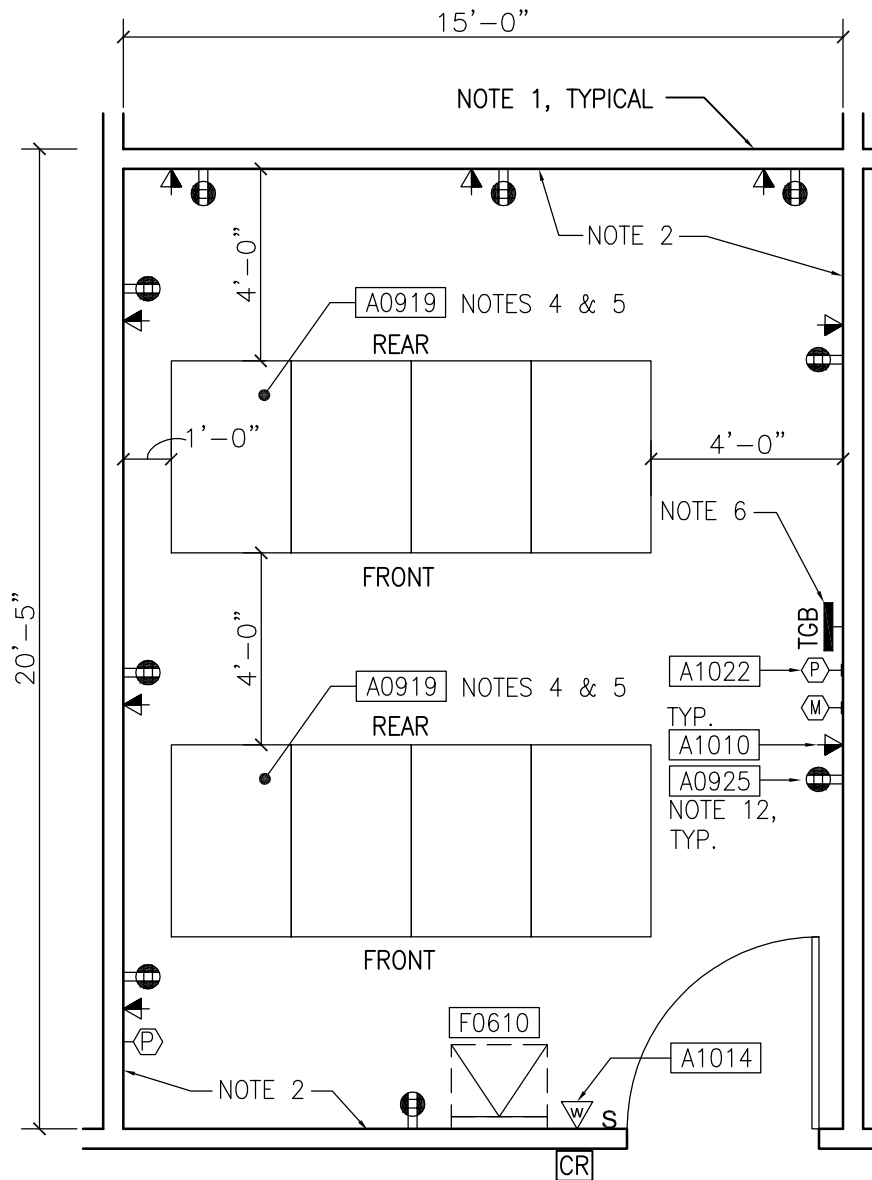

*MINIMUM ROOM SIZE IS 300 NSF.

SEE DESIGN STANDARDS PAGE OF THIS GUIDE PLATE FOR NUMBERED NOTES.

SEE SECTION 1 FOR SYMBOL LEGEND.

Note: Guide plates are graphical representations of selected room types, illustrating the integration of space, building systems (lights, HVAC, etc), and telecommunications equipment. The Design Team is responsible to perform the calculations to determine final quantities as well as location of each component for every project. Specific infrastructure design requirements are contained in PG 18-5: Equipment Guide List, PG 18-9: Space Planning Criteria, and PG 18-10: Design Manuals (by discipline) located in the VA's Technical Information Library (TIL)

<http://www.cfm.va.gov/TIL/>.

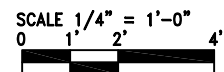

Antenna Headend Equipment Room (TEEQ1)
 Reflected Ceiling Plan

300 NSF*
 27.9 NSM

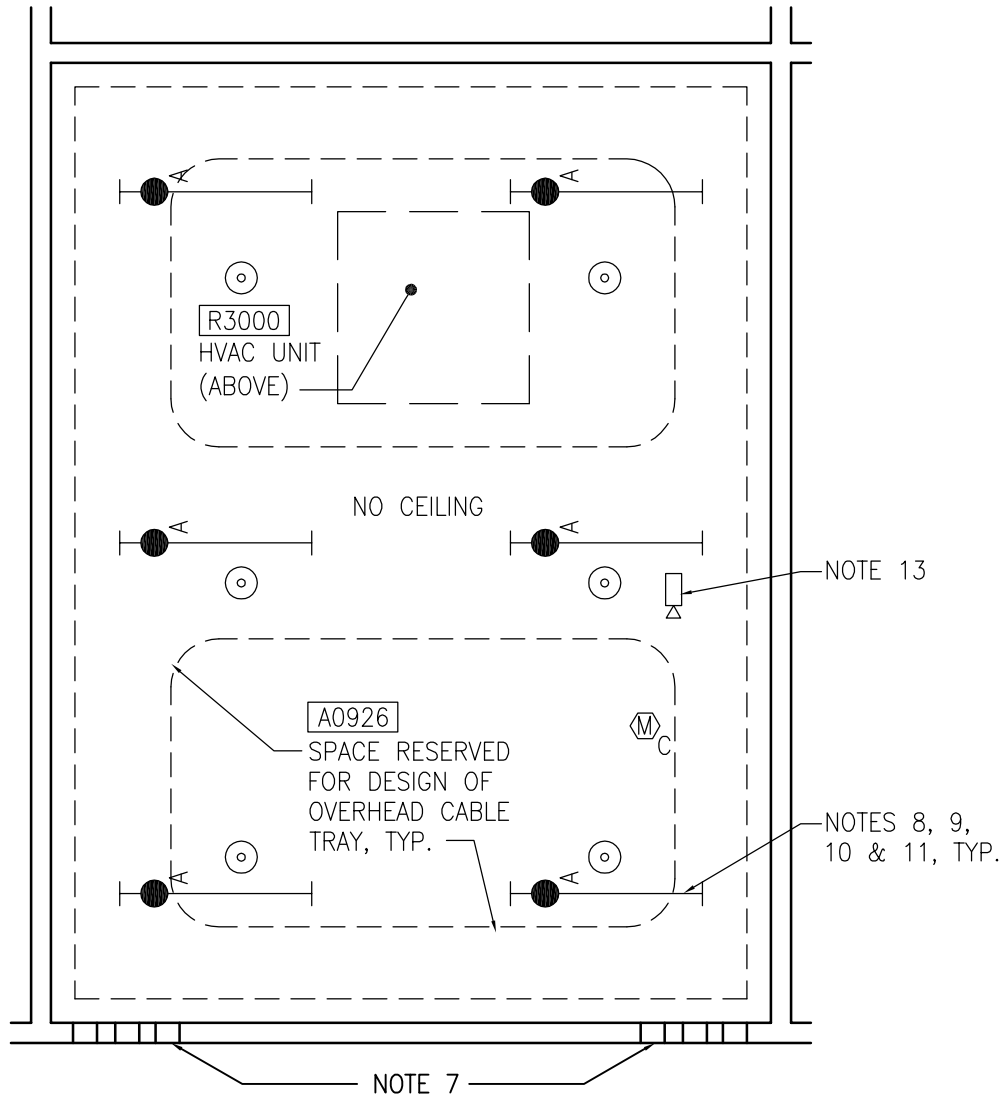

*MINIMUM ROOM SIZE IS 300 NSF.

SEE DESIGN STANDARDS PAGE OF THIS GUIDE PLATE FOR NUMBERED NOTES.

SEE SECTION 1 FOR SYMBOL LEGEND.

Note: Guide plates are graphical representations of selected room types, illustrating the integration of space, building systems (lights, HVAC, etc), and telecommunications equipment. The Design Team is responsible to perform the calculations to determine final quantities as well as location of each component for every project. Specific infrastructure design requirements are contained in PG 18-5: Equipment Guide List, PG 18-9: Space Planning Criteria, and PG 18-10: Design Manuals (by discipline) located in the VA's Technical Information Library (TIL)
<http://www.cfm.va.gov/TIL/>.

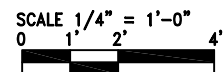

Antenna Headend Equipment Room (TEEQ1)

Design Standards

ARCHITECTURAL

Ceiling:	EXP
Ceiling Height:	--
Wall Finish:	GWB-P; Notes 1 and 2
Wainscot:	--
Base:	RB
Floor Finish:	SD, Note 3
Slab Depression:	--
Sound Protection:	--
Doors:	Size X (48"W x 84"H); Note 1
Notes:	--
1) Partitions and openings to comply with VA PSDM.	
2) Painted 3/4-inch fire retardant plywood over GWB.	
3) Static dissipative vinyl tile.	

SPECIAL EQUIPMENT

Notes:	
4) Racks and cabinets are CC. See Equipment List. See <i>Equipment Modules</i> page 4-3 for typical rack and cabinet dimensions and clearances. Cabinets are shown; racks may be required per OIT.	
5) Systems are VV.	
6) Provide Telecommunications Bonding Backbone (EDM 8.3), and conduit connectivity (EDM Table 7-1).	
7) Re-usable penetration firestopping system, type and size as required to match cable tray cross-sectional area; MCS 07 84 00.	

LIGHTING

General:	Refer to <u>Electrical Design Manual</u> .
Special:	--
Notes:	
8) All lighting shall be connected to the Critical Branch of the ESS (EDM 4.6).	
9) 50 average maintained fc illumination level.	
10) Suspended three-lamp fluorescent strip lighting fixture with wireguard and F32T8 lamps, 3500°K, CRI=70 (minimum).	
11) Exact quantity, location, and lamping of fixtures shall be chosen to meet the footcandle requirement.	

POWER

General:	Refer to <u>Electrical Design Manual</u> .
Emergency:	Refer to <u>Electrical Design Manual</u> .
Notes:	
12) All receptacles and equipment shall be connected to UPS power (EDM 5.3), and the UPS equipment connected to the Critical Branch of the ESS (EDM 4.6).	

COMMUNICATION/SPECIAL SYSTEMS

Data:	Yes
Telephone:	Yes
Cable Television:	--
Duress Alarm:	Yes
Electronic Access and Door Control:	Yes
Intercom:	--
Motion Intrusion Detection (MID):	Yes
Nurse Call, Code One (Blue):	--
Public Address:	--
Security Surveillance Television (SSTV)	--
VA Satellite TV:	--
Video Teleconferencing (VTEL):	--
Notes:	--
13) Mount SSTV camera below cable tray.	

HEATING, VENTILATING AND AIR CONDITIONING

Inside Design Conditions:	
Indoor design temperature shall be 64-75 degrees F, with relative humidity between 30% and 55%.	
Notes:	
14) Provide a dedicated, thermostatically-controlled, generator-backed mechanical cooling unit.	

PLUMBING AND MEDICAL GASES

Cold Water:	--
Hot Water:	--
Laboratory Air:	--
Laboratory Vacuum:	--
Sanitary Drain:	--
Reagent Grade Water:	--
Medical Air:	--
Medical Vacuum:	--
Oxygen:	--
Notes:	
1) Do not run pipe containing liquids (such as water, drain, or steam) above this space; except as required to provide fire suppression for this space only.	



Antenna Headend Equipment Room (TEEQ1)

Equipment Guide List

JSN	NAME	QTY	AI	DESCRIPTION	SPEC
A1010	Telecommunication Outlet	8	CC	Telecommunication outlet location.	27 15 00
A0919	Cabinet, With Internal Equipment Mounting Rack, Steel	AR	CC	Cabinet with internal equipment mounting rack, steel.	27 11 00
A0921	Rack, Equipment, Freestanding, Steel	AR	CC	Equipment rack, freestanding, steel.	27 31 00
A1012	Telephone, Wall Mounted, 1 Line, With Speaker	1	VV	Telephone, wall mounted. 1 line, with speaker	
F0610	Desk, Folding, W/M	1	CC	Wall mounted fold down desk, approximately 18" H x 23" W x 3" D, with writing surface, pencil-pen rack and multiple form holders.	12 31 00 Or 12 32 00
A0925	Receptacle, Electrical, Quadraplex	9	CC	Receptacle, quadraplex, 120 V.	26 27 26
A1022	Button, Alarm, Security/Duress	1	CC	Alarm button, Security/Duress.	27 52 31
R3000	Air Conditioner, Computer Room, Wall or Ceiling Mounted	AR	CC	Process cooling, split system or chilled water, air conditioning unit designed for computer room use. Unit shall be packaged, factory assembled, prewired, and pre-piped; consisting of cabinet, fans, filters, humidifier, and controls. Condensing unit may be remote, air cooled; or integral water cooled type.	23 81 23
				End of Equipment Guide List	



Demarc Room (TEDR1)

Min. 100 NSF

Floor Plan

9.3 NSM

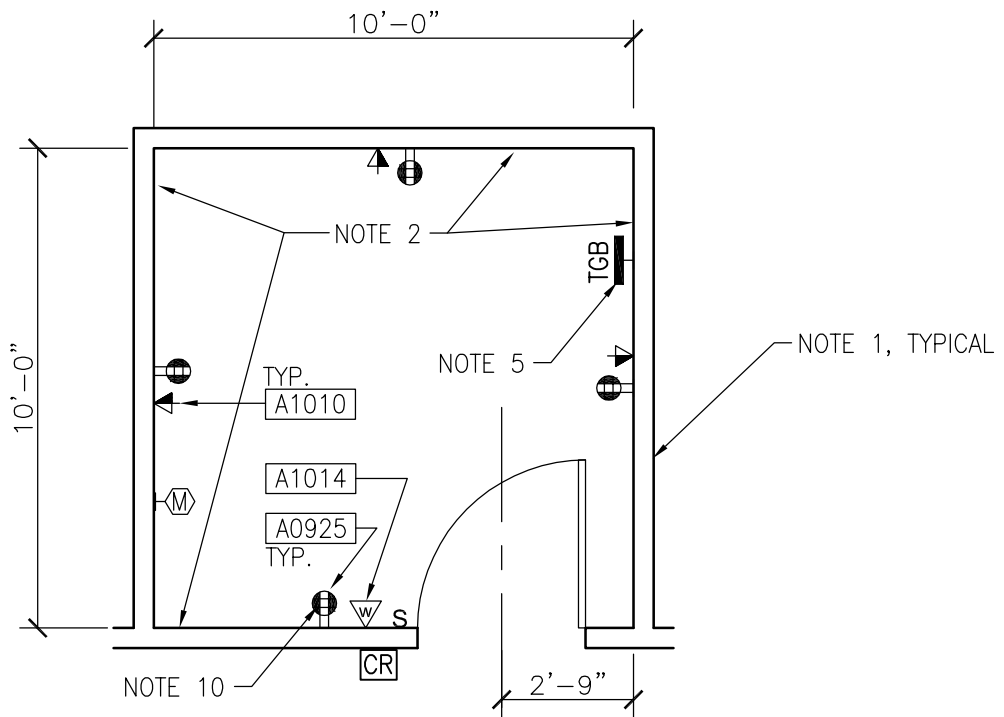

SEE DESIGN STANDARDS PAGE OF THIS GUIDE PLATE FOR NUMBERED NOTES.

SEE SECTION 1 FOR SYMBOL LEGEND.

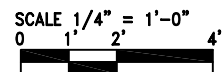

Note: Guide plates are graphical representations of selected room types, illustrating the integration of space, building systems (lights, HVAC, etc), and telecommunications equipment. The Design Team is responsible to perform the calculations to determine final quantities as well as location of each component for every project. Specific infrastructure design requirements are contained in PG 18-5: Equipment Guide List, PG 18-9: Space Planning Criteria, and PG 18-10: Design Manuals (by discipline) located in the VA's Technical Information Library (TIL)

<http://www.cfm.va.gov/TIL/>.

Demarc Room (TEDR1)
Reflected Ceiling Plan

Min. 100 NSF
9.3 NSM

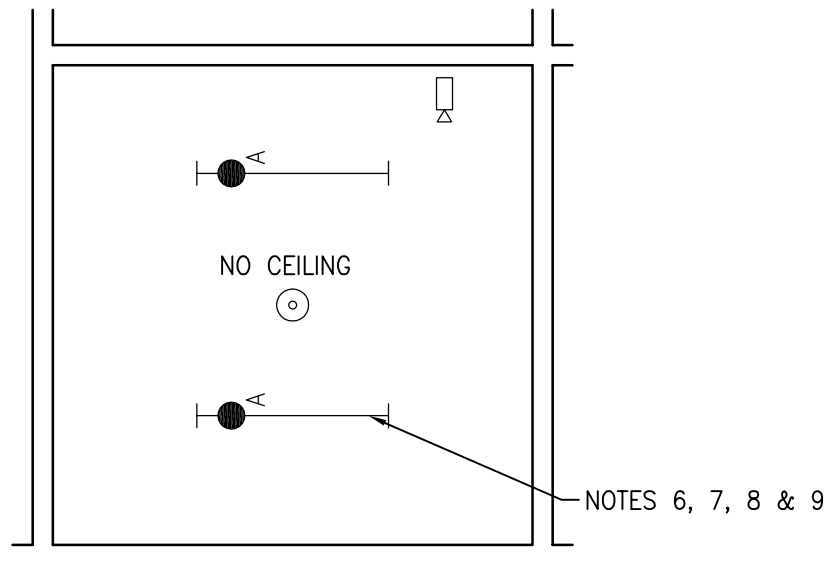

SEE DESIGN STANDARDS PAGE OF THIS GUIDE PLATE FOR NUMBERED NOTES.

SEE SECTION 1 FOR SYMBOL LEGEND.

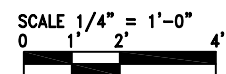

Note: Guide plates are graphical representations of selected room types, illustrating the integration of space, building systems (lights, HVAC, etc), and telecommunications equipment. The Design Team is responsible to perform the calculations to determine final quantities as well as location of each component for every project. Specific infrastructure design requirements are contained in PG 18-5: Equipment Guide List, PG 18-9: Space Planning Criteria, and PG 18-10: Design Manuals (by discipline) located in the VA's Technical Information Library (TIL) <http://www.cfm.va.gov/TIL/>.

Demarc Room (TEDR1)

Design Standards

ARCHITECTURAL

Ceiling:	EXP
Ceiling Height:	--
Wall Finish:	GWB; Notes 1 and 2
Wainscot:	--
Base:	RB
Floor Finish:	SD, Note 3
Slab Depression:	--
Sound Protection:	--
Doors:	Size U (42"W x 84"H); Note 1
Notes:	
1)	Partitions and openings to comply with VA PSDM.
2)	Painted 3/4-inch fire retardant plywood over GWB.
3)	Static dissipative vinyl tile.

SPECIAL EQUIPMENT

Notes:	
4)	Systems are VV.
5)	Provide Telecommunications Bonding Backbone (EDM 8.3), and conduit connectivity (EDM Table 7-1).

LIGHTING

General:	Refer to <u>Electrical Design Manual</u> .
Special:	--
Notes:	
6)	All lighting shall be connected to the Critical Branch of the ESS (EDM 4.6).
7)	30 average maintained fc illumination level.
8)	Suspended three-lamp fluorescent strip lighting fixture with wireguard and F32T8 lamps, 3500°K, CRI=70 (minimum).
9)	Exact quantity, location, and lamping of fixtures shall be chosen to meet the footcandle requirement.

POWER

General:	Refer to <u>Electrical Design Manual</u> .
Emergency:	Refer to <u>Electrical Design Manual</u> .
Notes:	--
10)	All receptacles and equipment shall be connected to the Critical Branch of the ESS (EDM 4.6).

COMMUNICATION/SPECIAL SYSTEMS

Data:	Yes
Telephone:	Yes
Cable Television:	--
Duress Alarm:	--
Electronic Access and Door Control:	Yes
Intercom:	--
Motion Intrusion Detection (MID):	Yes
Nurse Call, Code One (Blue):	--
Public Address:	--
Security Surveillance Television (SSTV):	Yes
VA Satellite TV:	--
Video Conferencing (VTEL):	--
Notes:	--

HEATING, VENTILATING AND AIR CONDITIONING

Inside Design Conditions:	
	Indoor design temperature shall be 64-75 degrees F, with relative humidity between 30% and 55%.
Notes:	
11)	If active equipment is present, provide a dedicated, thermostatically-controlled, generator-backed mechanical cooling unit.

PLUMBING AND MEDICAL GASES

Cold Water:	--
Hot Water:	--
Laboratory Air:	--
Laboratory Vacuum:	--
Sanitary Drain:	--
Reagent Grade Water:	--
Medical Air:	--
Medical Vacuum:	--
Oxygen:	--
Notes:	
12)	Do not run pipe containing liquids (such as water, drain, or steam) above this space; except as required to provide fire suppression for this space only.



Demarc Room (TEDR1)

Equipment Guide List

JSN	NAME	QTY	AI	DESCRIPTION	SPEC
A1010	Telecommunication Outlet	3	CC	Telecommunication outlet location.	27 15 00
A1014	Telephone, Wall Mounted, 1 Line, With Speaker	1	VV	Telephone, wall mounted, 1 line, with speaker.	
A0925	Receptacle, Electrical, Quadraplex	4	CC	Receptacle, quadraplex, 120 V.	26 27 26
				End of Equipment List	



Telecommunications Room (TETR1)

200 NSF*

Floor Plan

18.6 NSM

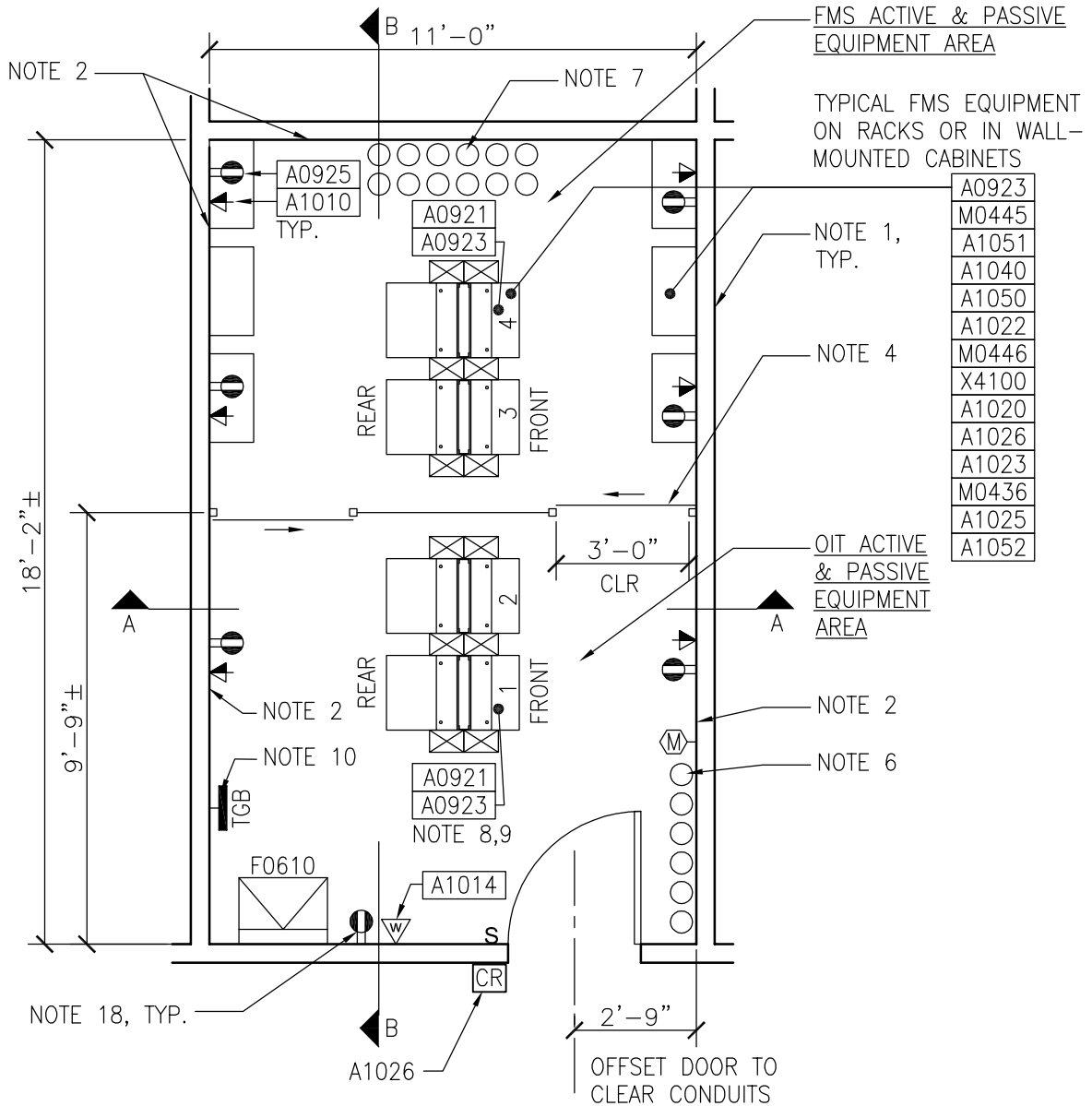

*MINIMUM ROOM SIZE IS 20 NSF, FOR FACILITY SIZES BELOW 1000 NSF. ROOM SHOWN IS FOR FACILITY SIZES 1000 NSF AND LARGER. QUANTITY OF ROOMS AS REQUIRED.

SEE DESIGN STANDARDS PAGE OF THIS GUIDE PLATE FOR NUMBERED NOTES.

SEE SECTION 1 FOR SYMBOL LEGEND.

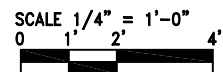

Note: Guide plates are graphical representations of selected room types, illustrating the integration of space, building systems (lights, HVAC, etc), and telecommunications equipment. The Design Team is responsible to perform the calculations to determine final quantities as well as location of each component for every project. Specific infrastructure design requirements are contained in PG 18-5: Equipment Guide List, PG 18-9: Space Planning Criteria, and PG 18-10: Design Manuals (by discipline) located in the VA's Technical Information Library (TIL) <http://www.cfm.va.gov/TIL/>.

Telecommunications Room (TETR1)

200 NSF*

Reflected Ceiling Plan

18.6 NSM

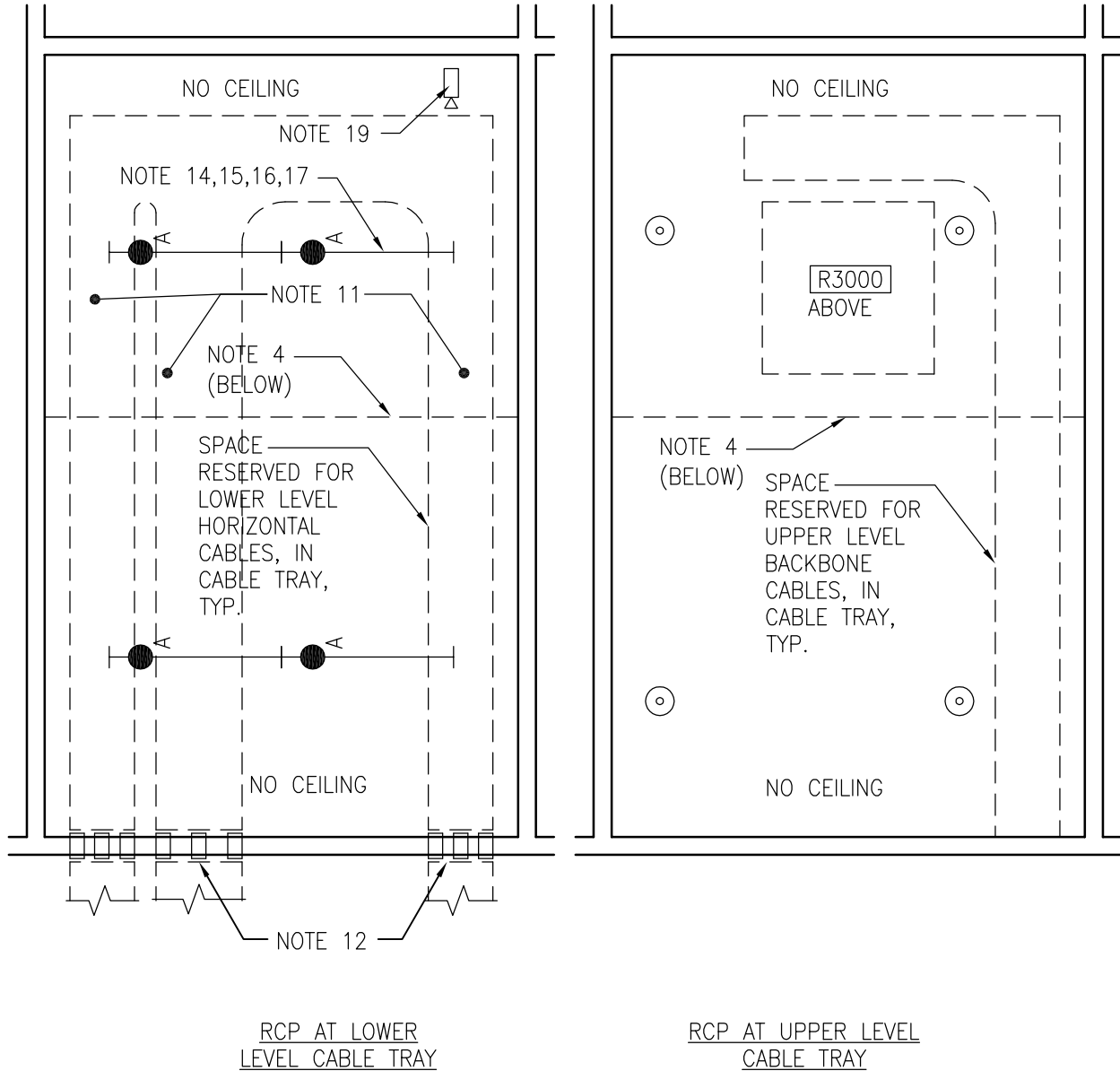

*MINIIMUM ROOM SIZE IS 20 NSF, FOR FACILITY SIZES BELOW 1000 NSF. ROOM SHOWN IS FOR FACILITY SIZES 1000 NSF AND LARGER. QUANTITY OF ROOMS AS REQUIRED.

SEE DESIGN STANDARDS PAGE OF THIS GUIDE PLATE FOR NUMBERED NOTES.
SEE SECTION 1 FOR SYMBOL LEGEND.

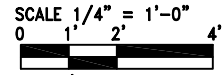

Note: Guide plates are graphical representations of selected room types, illustrating the integration of space, building systems (lights, HVAC, etc), and telecommunications equipment. The Design Team is responsible to perform the calculations to determine final quantities as well as location of each component for every project. Specific infrastructure design requirements are contained in PG 18-5: Equipment Guide List, PG 18-9: Space Planning Criteria, and PG 18-10: Design Manuals (by discipline) located in the VA's Technical Information Library (TIL) <http://www.cfm.va.gov/TIL/>.

Telecommunications Room (TETR1)

Section A-A

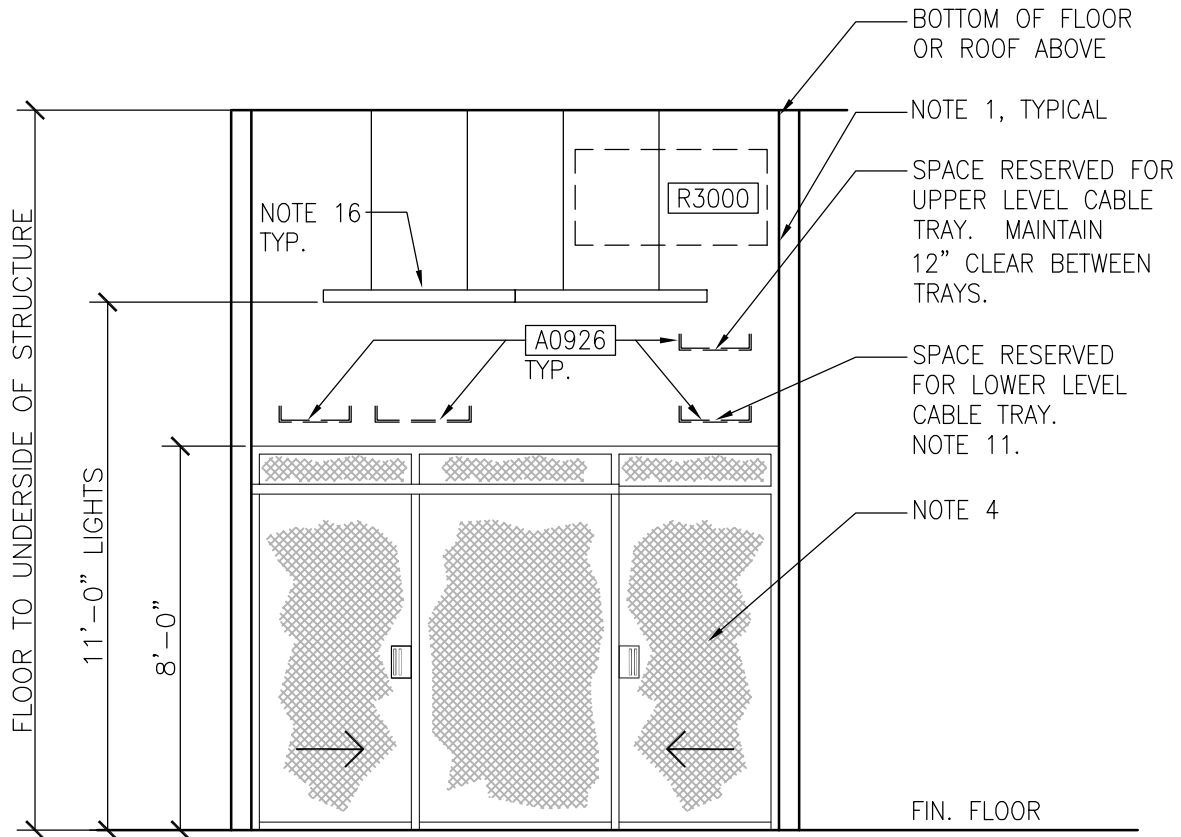

SEE DESIGN STANDARDS PAGE OF THIS GUIDE PLATE FOR NUMBERED NOTES.

SEE SECTION 1 FOR SYMBOL LEGEND.

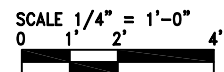

Note: Guide plates are graphical representations of selected room types, illustrating the integration of space, building systems (lights, HVAC, etc), and telecommunications equipment. The Design Team is responsible to perform the calculations to determine final quantities as well as location of each component for every project. Specific infrastructure design requirements are contained in PG 18-5: Equipment Guide List, PG 18-9: Space Planning Criteria, and PG 18-10: Design Manuals (by discipline) located in the VA's Technical Information Library (TIL)
<http://www.cfm.va.gov/TIL/>.

Telecommunications Room (TETR1)

Section B-B

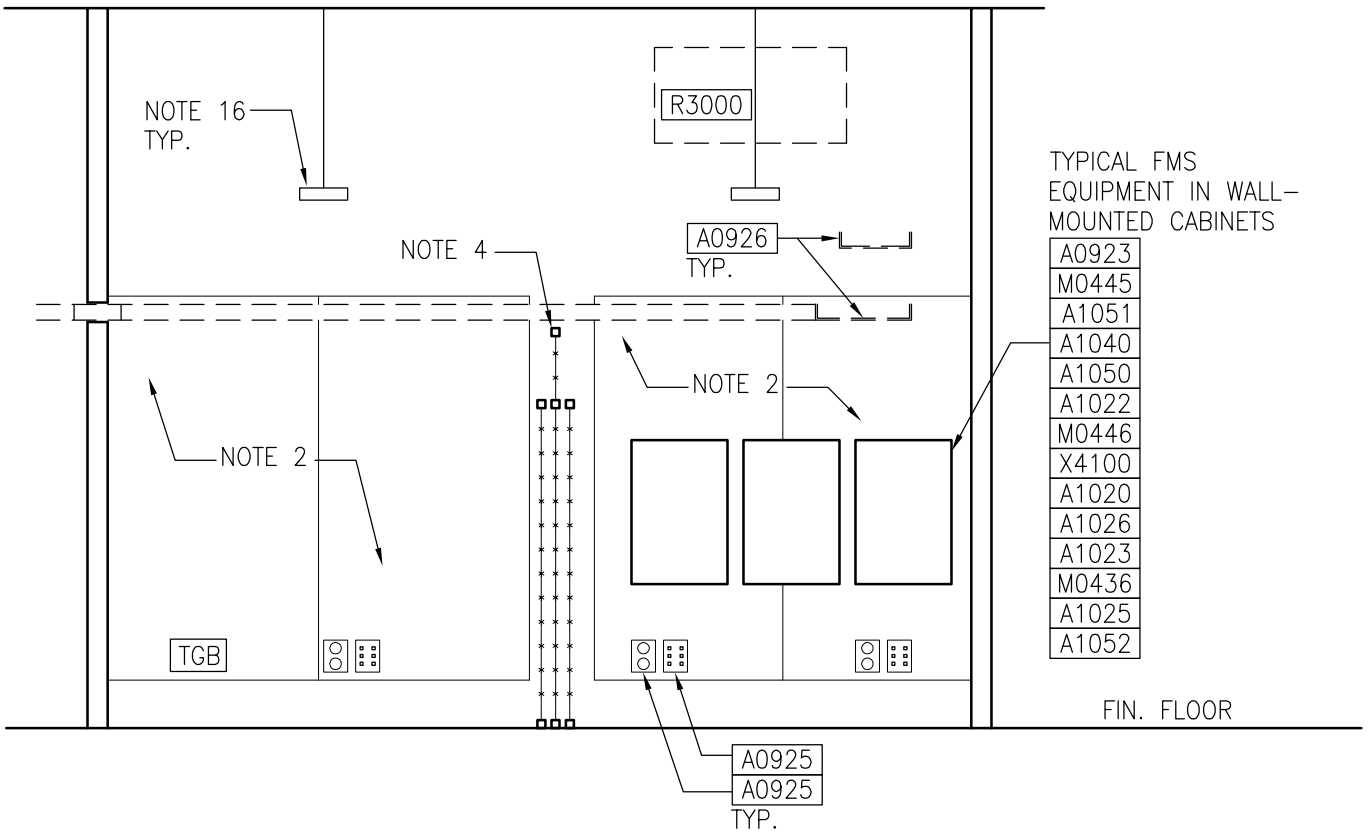

SEE DESIGN STANDARDS PAGE OF THIS GUIDE PLATE FOR NUMBERED NOTES.
SEE SECTION 1 FOR SYMBOL LEGEND.

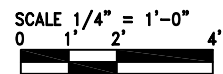

Note: Guide plates are graphical representations of selected room types, illustrating the integration of space, building systems (lights, HVAC, etc), and telecommunications equipment. The Design Team is responsible to perform the calculations to determine final quantities as well as location of each component for every project. Specific infrastructure design requirements are contained in PG 18-5: Equipment Guide List, PG 18-9: Space Planning Criteria, and PG 18-10: Design Manuals (by discipline) located in the VA's Technical Information Library (TIL)
<http://www.cfm.va.gov/TIL/>.

Telecommunications Room (TETR1)

Design Standards

ARCHITECTURAL

Ceiling:	EXP
Ceiling Height:	--
Wall Finish:	GWB; Notes 1 and 2
Wainscot:	--
Base:	RB
Floor Finish:	SD, Note 3
Slab Depression:	--
Sound Protection:	--
Doors:	Size V (44"W x 84"H); Note 1
Notes:	

- 1) Partitions and openings to comply with VA PSDM.
- 2) Painted 3/4-inch fire retardant plywood over GWB.
- 3) Static dissipative vinyl tile.
- 4) Optional Wire Mesh partition to 96"H with lockable, sliding, wire mesh gates (36"W x 93"H) at each opening. Provide to separate OIT and FMS equipment if lockable enclosures are not used at racks or cabinets.
- 5) In multi-floor buildings, TRs shall be stacked vertically through the building, with TRs in each stack located to align directly above or below each other.

SPECIAL EQUIPMENT

Notes:

- 6) 4" conduits through floor for OIT backbone distribution at stacked TRs. 1 conduit required for each TR. Conduits sleeved to TR above (if applicable) are not shown.
- 7) 4" conduits through floor for FMS backbone distribution at stacked TRs. 2 conduits required for each TR. Conduits sleeved to TR above (if applicable) are not shown.
- 8) Racks and cabinets (racks shown) are CC. See Equipment List. See *Equipment Modules* page 4-3 for typical rack and cabinet dimensions and clearances.
- 9) OIT systems are VV.
- 10) Provide Telecommunications Bonding Backbone (EDM 8.3), and conduit connectivity (EDM Table 7-1).

SPECIAL EQUIPMENT (continued)

- 11) If wire mesh partition is not provided, lower cable tray shall be mounted such that bottom of tray is 6" above top of rack or cabinet.
- 12) Re-usable penetration firestopping system, type and size as required to match cable tray cross-sectional area (MCS 07 84 00).
- 13) Space reserved for wall-mounted 110 termination blocks.

LIGHTING

General: Refer to Electrical Design Manual.

Special: --

Notes: --

- 14) All lighting shall be connected to the Critical Branch of the ESS (EDM 4.6).
- 15) 50 average maintained fc illumination level.
- 16) Suspended three-lamp fluorescent strip lighting fixture with wireguard and F32T8 lamps, 3500°K, CRI=70 (minimum).
- 17) Exact quantity, location, and lamping of fixtures shall be chosen to meet the footcandle requirement.

POWER

General: Refer to Electrical Design Manual.

Emergency: Refer to Electrical Design Manual.

Notes: --

- 18) All receptacles and equipment shall be connected to UPS power (EDM 5.3), and the UPS equipment connected to the Critical Branch of the ESS (EDM 4.6).

Continued on Next Page



Telecommunications Room (TETR1)

Design Standards (continued)

COMMUNICATION/SPECIAL SYSTEMS

Data:	Yes
Telephone:	Yes
Cable Television:	--
Duress Alarm:	--
Electronic Access and Door Control:	Yes
Intercom:	--
Motion Intrusion Detection (MID):	Yes
Nurse Call, Code One (Blue):	--
Public Address:	--
Security Surveillance Television (SSTV)	Yes
VA Satellite TV:	--
Video Teleconferencing (VTEL):	--
Notes:	--
19) SSTV camera mounted below cable tray.	

HEATING, VENTILATING AND AIR CONDITIONING

Inside Design Conditions:

Indoor design temperature shall be 64-75 degrees F, with relative humidity between 30% and 55%.

Notes:

- 20) Provide a dedicated, thermostatically-controlled, generator-backed mechanical cooling unit.

PLUMBING AND MEDICAL GASES

Cold Water:	--
Hot Water:	--
Laboratory Air:	--
Laboratory Vacuum:	--
Sanitary Drain:	--
Reagent Grade Water:	--
Medical Air:	--
Medical Vacuum:	--
Oxygen:	--
Notes:	

- 21) Do not run pipe containing liquids (such as water, drain, or steam) above this space; except as required to provide fire suppression for this space only.



Telecommunications Room (TETR1)

Equipment Guide List

JSN	NAME	QTY	AI	DESCRIPTION	SPEC
A0926	Tray, Cable, for Communications Systems	AR	CC	Cable trays for communications systems.	26 05 36
A0919	Cabinet, With Internal Equipment Mounting Rack, Steel	AR	CC	Cabinet with internal equipment mounting rack, steel.	27 11 00
A0921	Rack, Equipment, Freestanding, Steel	AR	CC	Equipment rack, freestanding, steel.	27 31 00
A0923	Wire Management System	AR	CC	Wire management system.	27 31 00
A0920	Cross-Connection System (CCS)	AR	CC	Equipment breakout, Termination Connector, (or Bulkhead), and Patch Panels	27 11 00
M0445	Master Antenna Television System	AR	CC	Equipment as required for fully operating Master Antenna Television (TV) system.	27 41 31
A1051	Public Address and Mass Notification Systems	AR	CC	Equipment as required for fully operating Emergency/Public Safety Public Address and Mass Notification communication (PA) system.	27 51 16
A1040	Intercommunications and Program Systems	AR	CC	Equipment as required for fully operating Intercommunications system.	27 51 23
A1050	Nurse Call Code Blue Systems	AR	CC	Equipment as required for fully operating Critical Service Nurse-Call and Life Safety Code Blue communication system.	27 52 23
A1022	Security Emergency Call / Duress Alarm / Telecommunications Systems and Equipment	AR	CC	Equipment as required for fully operating Security Emergency Call / Duress Alarm / Telecommunications systems.	27 52 31
M0446	Miscellaneous Medical Systems	AR	CC	Equipment as required for installation and connection of the miscellaneous medical equipment and systems, including: Psychiatric (mental health) Security Unit Door Signal Systems; Narcotics Storage Signal Systems; and Elapsed Time Indicators.	27 52 41
X4100	Physical Access Control System			Equipment as required for fully functioning Physical Access Control System.	28 13 11
A1020	Access Control System and Database Management	AR	CC	Equipment as required for fully functioning Access Control System and Database Management system.	28 13 16
A1026	Security Access Detection	AR	CC	Equipment as required for fully functioning Detection and Screening System, referred to as the Security Access Detection system.	28 13 53
A1023	Intrusion Detection System.	AR	CC	Equipment as required for fully functioning Intrusion Detection System, referred to as IDS.	28 16 11
M0436	Video Surveillance	AR	CC	Equipment as required for fully functioning Video Surveillance System, which is identified as the Closed Circuit Television System, referred to as the CCTV System.	28 23 00
				(continued on next page)	



Telecommunications Room (TETR1)

Equipment Guide List (continued)

JSN	NAME	QTY	AI	DESCRIPTION	SPEC
A1025	Electronic Personal Protection System	AR	CC	Equipment as required for fully functioning Duress-Panic Alarms, Emergency Phones/ Call-Boxes, and Intercom Systems, referred to as EPPS System.	28 26 00
A1052	Fire Detection and Alarm	AR	CC	Equipment as required for fully functioning Fire Detection and Alarm system.	28 31 00
A1010	Telecommunication Outlet	7	CC	Telecommunication outlet location.	27 15 00
A1014	Telephone, Wall Mounted, 1 Line, With Speaker	1	VV	Telephone, wall mounted, 1 line, with speaker.	
A0925	Receptacle, Electrical, Quadraplex	7	CC	Receptacle, quadraplex, 120 V.	26 27 26
R3000	Air Conditioner, Computer Room, Wall or Ceiling Mounted (ceiling-mounted shown)	AR	CC	Process cooling, split system or chilled water, air conditioning unit designed for computer room use. Unit shall be packaged, factory assembled, prewired, and pre-piped; consisting of cabinet, fans, filters, humidifier, and controls. Condensing unit may be remote, air cooled; or integral water cooled type.	23 81 23
				End of Equipment Guide List	



Telephone Operators Room (TEOR1)

120 NSF*

Floor Plan

11.1 NSM

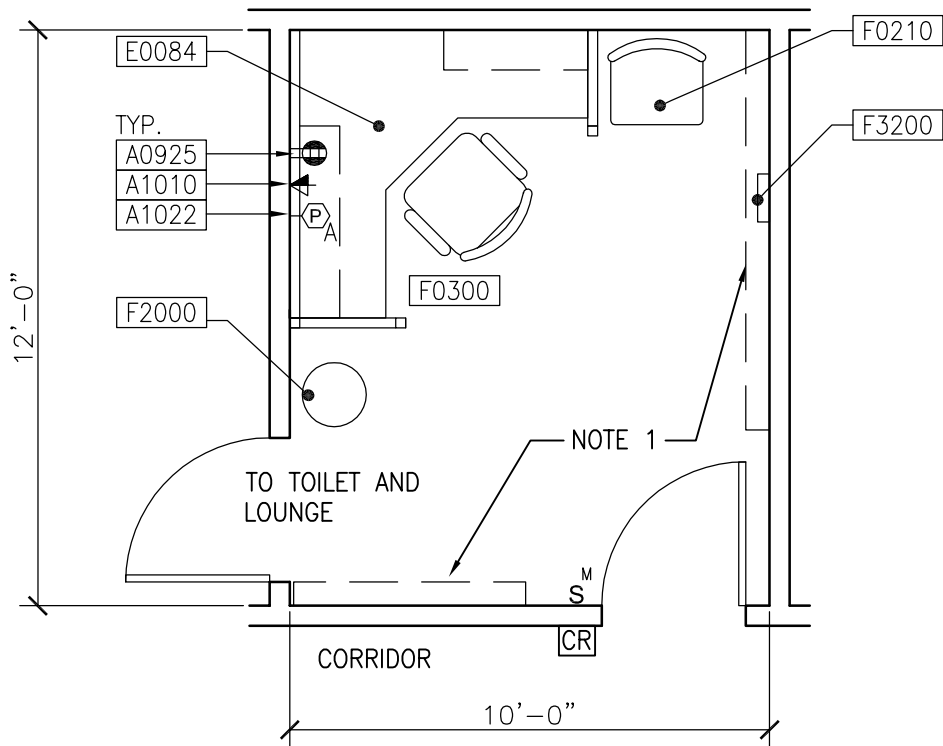

*MINIIMUM ROOM SIZE.

SEE DESIGN STANDARDS PAGE OF THIS GUIDE PLATE FOR NUMBERED NOTES.

SEE SECTION 1 FOR SYMBOL LEGEND.

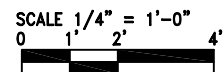

Note: Guide plates are graphical representations of selected room types, illustrating the integration of space, building systems (lights, HVAC, etc), and telecommunications equipment. The Design Team is responsible to perform the calculations to determine final quantities as well as location of each component for every project. Specific infrastructure design requirements are contained in PG 18-5: Equipment Guide List, PG 18-9: Space Planning Criteria, and PG 18-10: Design Manuals (by discipline) located in the VA's Technical Information Library (TIL) <http://www.cfm.va.gov/TIL/>.

Telephone Operators Room (TEOR1)

120 NSF*

Reflected Ceiling Plan

11.1 NSM

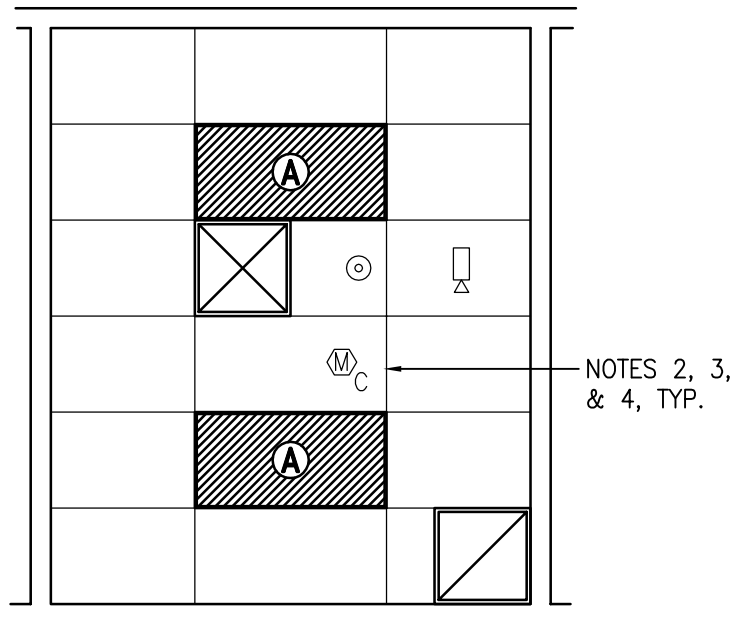

*MINIIMUM ROOM SIZE.

SEE DESIGN STANDARDS PAGE OF THIS GUIDE PLATE FOR NUMBERED NOTES.

SEE SECTION 1 FOR SYMBOL LEGEND.

Note: Guide plates are graphical representations of selected room types, illustrating the integration of space, building systems (lights, HVAC, etc), and telecommunications equipment. The Design Team is responsible to perform the calculations to determine final quantities as well as location of each component for every project. Specific infrastructure design requirements are contained in PG 18-5: Equipment Guide List, PG 18-9: Space Planning Criteria, and PG 18-10: Design Manuals (by discipline) located in the VA's Technical Information Library (TIL)

<http://www.cfm.va.gov/TIL/>.

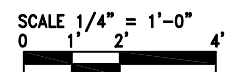

Telephone Operators Room (TEOR1)

Design Standards

ARCHITECTURAL

Ceiling:	AT
Ceiling Height:	9'-0"
Wall Finish:	GWB-P
Wainscot:	--
Base:	RB
Floor Finish:	CP / CPT
Slab Depression:	--
Sound Protection:	STC 45
Doors:	Size S (36"W x 84"H); Type 19/20

Notes:

- 1) Wall space for Systems Alarm Panels as required.

SPECIAL EQUIPMENT

Notes: --

LIGHTING

General: Refer to Electrical Design Manual.

Special: --

Notes:

- 2) 50 average maintained fc illumination level.
- 3) Recessed three-lamp fluorescent lighting fixture with acrylic lens and F32T8 lamps, 3500°K, CRI=70 (minimum), dual-level occupancy-sensor switched. Switch inner lamps on the first switch and outer lamps on the second switch.
- 4) Exact quantity, location, and lamping of fixtures shall be chosen to meet the footcandle requirement.

POWER

General: Refer to Electrical Design Manual.

Emergency: Refer to Electrical Design Manual.

Notes:

- 5) All receptacles and equipment shall be connected to the Critical Branch of the ESS (EDM 4.6).

COMMUNICATION/SPECIAL SYSTEMS

Data:	Yes
Telephone:	Yes
Cable Television:	--
Duress Alarm:	Yes
Electronic Access and Door Control:	Yes
Intercom:	--
Motion Intrusion Detection (MID):	Yes
Nurse Call, Code One (Blue):	--
Public Address:	--
Security Surveillance Television (SSTV):	Yes
VA Satellite TV:	--
Video Teleconferencing (VTEL):	--
Notes:	--

HEATING, VENTILATING AND AIR CONDITIONING

Inside Design Conditions:

Refer to HVAC Design Manual.

Notes: --

PLUMBING AND MEDICAL GASES

Cold Water:	--
Hot Water:	--
Laboratory Air:	--
Laboratory Vacuum:	--
Sanitary Drain:	--
Reagent Grade Water:	--
Medical Air:	--
Medical Vacuum:	--
Oxygen:	--
Notes:	--



Telephone Operators Room (TEOR1)

Equipment Guide List

JSN	NAME	QTY	AI	DESCRIPTION	SPEC
A1010	Telecommunication Outlet	1	CC	Telecommunication outlet location.	27 15 00
A1015	Telephone, Desk, Multiple Line	1	VV	Telephone, desk, multiple line.	
F0210	Chair, Side, Without Arms	1	VV	Upholstered side chair approximately 32" high X 19" wide X 23" deep with floor glides. Seat is non-tilting and without arms.	
F0300	Chair, Task, Swivel	1	VV	Task chair, approximately 34" H x 26" W x 22" D with adjustable arms and a five caster adjustable swivel base. Seat and back are foam padded and upholstered in woven fabric or vinyl.	
E0084	Workstation, Corner Work Surf, Free Stand, 72x72	1	VV	Approximately 64" H x 77" W x 77" D, this typically includes: 4 Standard Solid Panels 2 Panel-to-Panel Connectors 1 Panel Connector, 2-Way Corner 2 Finished End Hardware 3 Lockable Flipper Units 3 Lights 2 Tackboards 2 Tool Rails 2 Paper Trays 1 Diagonal Tray 2 Cantilevered Work Surfaces 1 Cantilevered Corner Work Surface 1 Freestanding Work Surface 1 Adjustable Keyboard Tray 1 Mobile Pedestal, Box/File 1 Pencil Drawer 2 Support Panels.	
F2000	Basket, Wastepaper, Round Metal	1	VV	Approximately 18" high X 16" diameter. This metal unit is used to collect and temporarily store small quantities of paper refuse in patient rooms, administrative areas and nursing stations.	
F3200	Clock, Battery, 12" Diameter	1	VV	Round surface, easy to read numbers with sweep second hand. Wall mounted unit for use when impractical to install a fully synchronized clock system. Battery operated, (batteries not included).	
M1801	Computer, Microprocessing, w/ Flat Panel Monitor	1	VV	Desk top microprocessing computer. The unit shall consist of a central processing mini tower, flat panel monitor, keyboard, mouse and speakers. The computer is used throughout the facility to input, manipulate and retrieve information.	
A0925	Receptacle, Electrical, Quadraplex	1	CC	Receptacle, quadraplex, 120 V.	26 27 26
A1022	Button, Alarm, Security/Duress	1	CC	Alarm button, Security/Duress.	27 52 31
				(continued on next page)	

Telephone Operators Room (TEOR1)

Equipment Guide List (continued)

JSN	NAME	QTY	AI	DESCRIPTION	SPEC
	Alarm Panels			Provide alarm panels as required for the following systems:	
A1050		1	CC	Nurse Call, Code One (Blue)	27 52 23
A1051		1	CC	Public Address / Emergency Notification	27 51 16
A1022		1	CC	Duress Alarm	28 26 00
A1052		1	CC	Fire Alarm	28 31 00
		1	CC	Medical Gas Alarms	27 62 00 27 63 00
A1020		1	CC	Access Control	
A1023				Intrusion Detection	
		1	CC	Emergency and/or Standby Generator(s)	26 22 13
				End of Equipment List	

For each additional FTE provide the following:

JSN	NAME	QTY	AI	DESCRIPTION	SPEC
A1010	Telecommunication Outlet	1	CC	Telecommunication outlet location.	27 15 00
A1015	Telephone, Desk, Multiple Line	1	VV	Telephone, desk, multiple line.	
F0300	Chair, Task, Swivel	1	VV	Task chair, approximately 34" H x 26" W x 22" D with adjustable arms and a five caster adjustable swivel base. Seat and back are foam padded and upholstered in woven fabric or vinyl.	27 52 23
E0084	Workstation, Corner Work Surf, Free Stand, 72x72	1	VV	Approximately 64" H x 77" W x 77" D	27 51 16
F2000	Basket, Wastepaper, Round Metal	1	VV	Approximately 18" high X 16" diameter. This metal unit is used to collect and temporarily store small quantities of paper refuse in patient rooms, administrative areas and nursing stations.	28 26 00
M1801	Computer, Microprocessing, w/ Flat Panel Monitor	1	VV	Desk top microprocessing computer. The unit shall consist of a central processing mini tower, flat panel monitor, keyboard, mouse and speakers. The computer is used throughout the facility to input, manipulate and retrieve information.	
A0925	Receptacle, Electrical, Quadraplex	1	CC	Receptacle, quadraplex, 120 V.	26 27 26
A1022	Button, Alarm, Security/Duress	1	CC	Alarm button, Security/Duress.	27 52 31
				End of Equipment List	

This page intentionally left blank.

Classroom, Computer Training (CLR03)

375 NSF*

Floor Plan

34.8 NSM

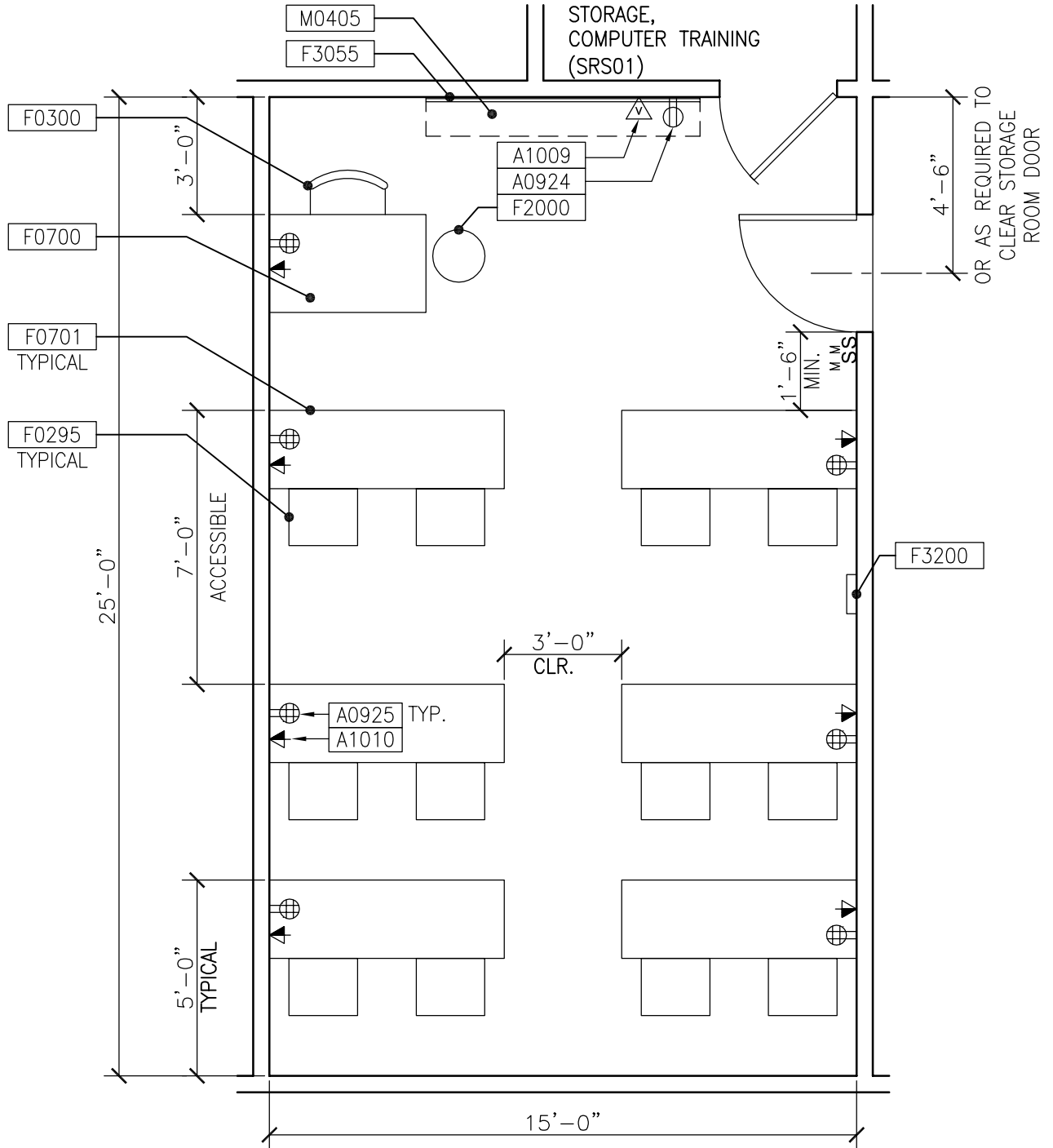

*MINIMUM ROOM SIZE.

SEE DESIGN STANDARDS PAGE OF THIS GUIDE PLATE FOR NUMBERED NOTES.

SEE SECTION 1 FOR SYMBOL LEGEND.

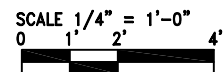

Note: Guide plates are graphical representations of selected room types, illustrating the integration of space, building systems (lights, HVAC, etc), and telecommunications equipment. The Design Team is responsible to perform the calculations to determine final quantities as well as location of each component for every project. Specific infrastructure design requirements are contained in PG 18-5: Equipment Guide List, PG 18-9: Space Planning Criteria, and PG 18-10: Design Manuals (by discipline) located in the VA's Technical Information Library (TIL)
<http://www.cfm.va.gov/TIL/>.

Classroom, Computer Training (CLR03)
Reflected Ceiling Plan

375 NSF*
34.8 NSM

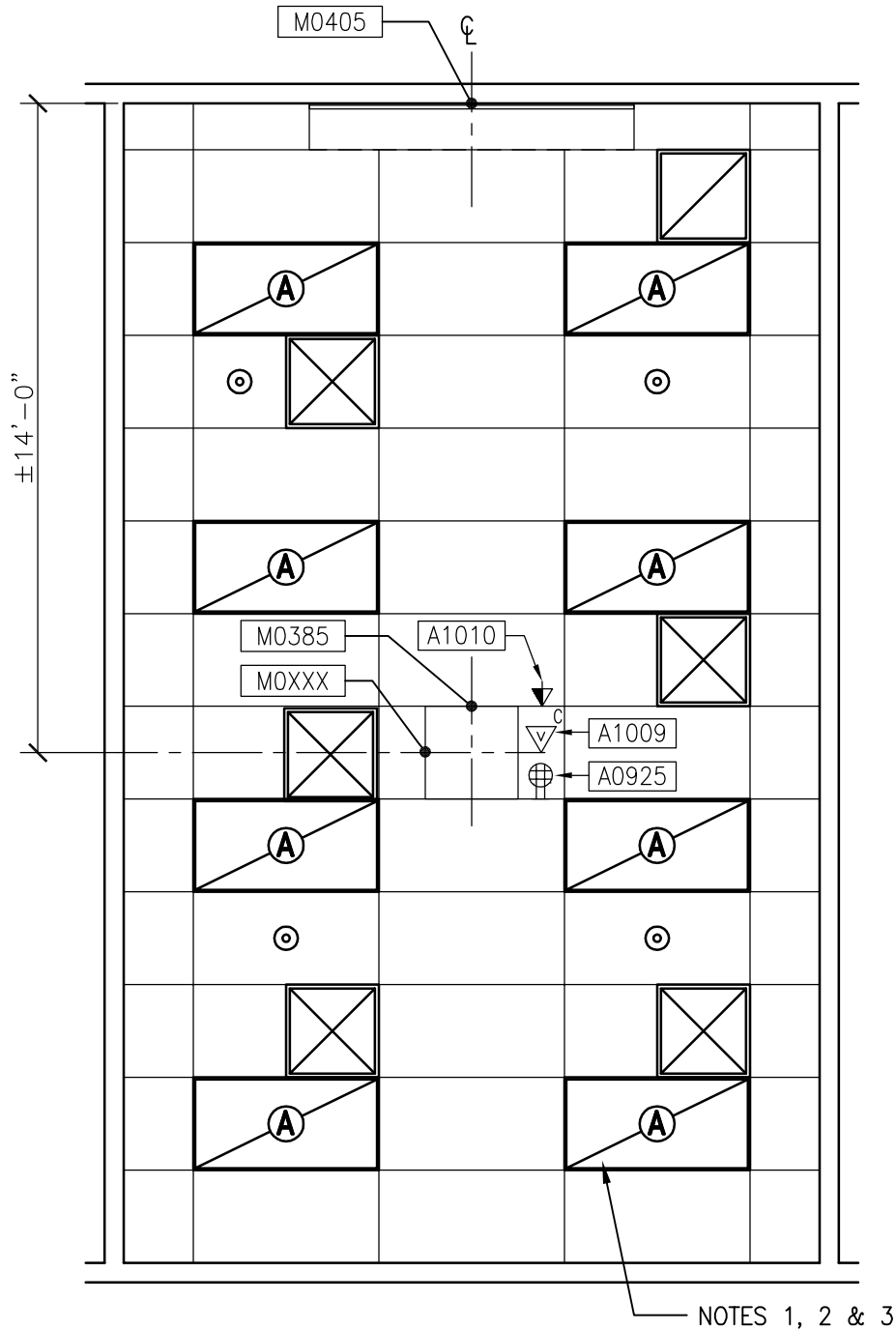

*MINIMUM ROOM SIZE.

SEE DESIGN STANDARDS PAGE OF THIS GUIDE PLATE FOR NUMBERED NOTES.

SEE SECTION 1 FOR SYMBOL LEGEND.

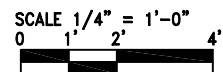

Note: Guide plates are graphical representations of selected room types, illustrating the integration of space, building systems (lights, HVAC, etc), and telecommunications equipment. The Design Team is responsible to perform the calculations to determine final quantities as well as location of each component for every project. Specific infrastructure design requirements are contained in PG 18-5: Equipment Guide List, PG 18-9: Space Planning Criteria, and PG 18-10: Design Manuals (by discipline) located in the VA's Technical Information Library (TIL)
<http://www.cfm.va.gov/TIL/>.

Classroom, Computer Training (CLR03)

Design Standards

ARCHITECTURAL

Ceiling:	AT
Ceiling Height:	9'-0"
Wall Finish:	GWB-P
Wainscot:	--
Base:	RB
Floor Finish:	CP / CPT
Slab Depression:	--
Sound Protection:	STC 40
Doors:	Size S (36"W x 84"H)
Notes:	--

SPECIAL EQUIPMENT

Notes:	--
--------	----

LIGHTING

General: Refer to [Electrical Design Manual](#).

Special: --

Notes:

- 1) 50 average maintained fc illumination level.
- 2) Recessed two-lamp fluorescent lighting fixture with acrylic lens and F32T8 lamps, 3500°K, CRI=70 (minimum), dual-level occupancy-sensor switched. Switch inner lamps on the first switch and outer lamps on the second switch.
- 3) Exact quantity, location, and lamping of fixtures shall be chosen to meet the footcandle requirement.

POWER

General: Refer to [Electrical Design Manual](#).

Emergency: Refer to [Electrical Design Manual](#).

Notes: --

COMMUNICATION/SPECIAL SYSTEMS

Data:	Yes
Telephone:	Yes
Cable Television:	Yes
Duress Alarm:	--
Electronic Access and Door Control:	--
Intercom:	--
Motion Intrusion Detection (MID):	--
Nurse Call, Code One (Blue):	--
Public Address:	--
Security Surveillance Television (SSTV):	--
VA Satellite TV:	--
Video Teleconferencing (VTEL):	--
Notes:	--

HEATING, VENTILATING AND AIR CONDITIONING

Inside Design Conditions:

Refer to [HVAC Design Manual](#).

Notes: --

PLUMBING AND MEDICAL GASES

Cold Water:	--
Hot Water:	--
Laboratory Air:	--
Laboratory Vacuum:	--
Sanitary Drain:	--
Reagent Grade Water:	--
Medical Air:	--
Medical Vacuum:	--
Oxygen:	--
Notes:	--

Classroom, Computer Training (CLR03)

Equipment Guide List

JSN	NAME	QTY	A/I	DESCRIPTION	SPEC
A1010	Telecommunication Outlet	7	CC	Telecommunication outlet location.	27 15 00
A1016	Telephone, Desk, With Speaker	1	VV	Telephone, desk, with speaker.	
F0295	Chair, Stacking	12	VV	Approximately 34" H x 21" W x 24" D. May be stacked up to 20 high depending upon the model selected. These chairs are intended primarily as overflow capacity for conference rooms.	
F0300	Chair, task, Swivel	1	VV	Task chair, approximately 34" H x 26" W x 22" D with adjustable arms and a five caster adjustable swivel base. Seat and back are foam padded and upholstered in woven fabric or vinyl.	
F0700	Table, Computer, Medium Size	1	VV	Medium sized computer table, approximately 35" H x 48" W x 30" D with enough surface for a CPU, monitor, keyboard and (optional) printer.	
F0701	Table, Computer Training, Dual Workstation	6	VV	Computer classroom table, approximately 30" H x 72" W x 24" D with provision for two training workstations. Each workstation is to have a CPU holder, a recessed space for monitor, and a slide-out keyboard tray. Table shall include channel(s) for wire management, modesty panel, and adjustable height legs (26 to 32 inches).	
F2000	Basket, Wastepaper, Round Metal	1	VV	Approximately 18" H x 16" diameter. This metal unit is used to collect and temporarily store small quantities of paper refuse in patient rooms, administrative areas and nursing stations.	
F3055	Whiteboard, With Sliding Panels	1	CC	Standard installations consist of sliding panels and a fixed back panel with the choice of chalkboard, markerboard, bulletin board, or a combination of these choices.	10 11 13 10 11 23
F3200	Clock, Battery, 12" Diameter	1	VV	Round surface, easy to read numbers with sweep second hand. Wall mounted unit for use when impractical to install a fully synchronized clock system. Battery operated, (batteries not included).	
M0385	Projector, Multimedia/Data	1	VV	The projector shall provide computer and video projections. Minimum features included: Brightness of not less than 1500 ANSI (American National Standards Institute) Lumens, and a minimum resolution format of 1024 x 768 pixels (XGA). The projector shall be portable and weigh no more than 10 pounds. It shall include a zoom lens and computer and video input ports.	
				(continued on next page)	

Classroom, Computer Training (CLR03)

Equipment Guide List (continued)

JSN	NAME	QTY	AI	DESCRIPTION	SPEC
M0385	Mount, Projector, Ceiling	1	CC	Stationary universal mount and related accessories for ceiling installation of multimedia projectors. Mount shall allow for the alignment of the projector lens to the pivot axes and shall be adjustable to allow fine-tuning of the image to the viewing screen. Mount shall have 20 degrees of roll adjustment, 15 degrees of pitch adjustment and 360 degrees of swivel. Mount shall support up to 50 pounds. Requires adjacent duplex receptacle, telecommunication outlet, and video outlet.	11 52 16
M0405	Screen, Projection, 84x84	1	CC	Projection screen. 84 x 84 inches. Heavy duty wall or ceiling mounted manual pull-down screen. Equipped with grooved roller, a ball bearing mechanical system, and steel mounting brackets. Opens with one continuous motion. Convenient for classrooms, conference rooms, or auditorium	11 52 13
A0925	Receptacle, Electrical, Quadraplex	8	CC	Receptacle, quadraplex, 120 V.	26 27 26
A0924	Receptacle, Electrical, Duplex	1	CC	Receptacle, duplex, 120 V.	26 27 26
A1009	Outlet, Video	2	CC	Outlet, video.	26 05 33 26 27 26
				End of Equipment Guide List	

Classroom, Computer Training (CLR03)

Equipment Guide List (continued)

For each additional increment of 4 computer training workstations provide the following:

JSN	NAME	QTY	AI	DESCRIPTION	SPEC
A1010	Telecommunication Outlet	2	CC	Telecommunication outlet location.	27 15 00
F0295	Chair, Stacking	4	VV	Approximately 34" H x 21" W x 24" D.	
F0701	Table, Computer Training, Dual Workstation	2	VV	Computer classroom table, approximately 30" H x 72" W x 24" D with provision for two training workstations.	
M1801	Computer, Microprocessing, w/ Flat Panel Monitor	4	VV	Desk top microprocessing computer.	
A1009	Receptacle, Electrical, Quadraplex	2	CC	Receptacle, quadraplex, 120 V.	26 27 26
				End of Equipment Guide List	

Workroom, Projects (WRCH1)

200 NSF*

Floor Plan

18.6 NSM

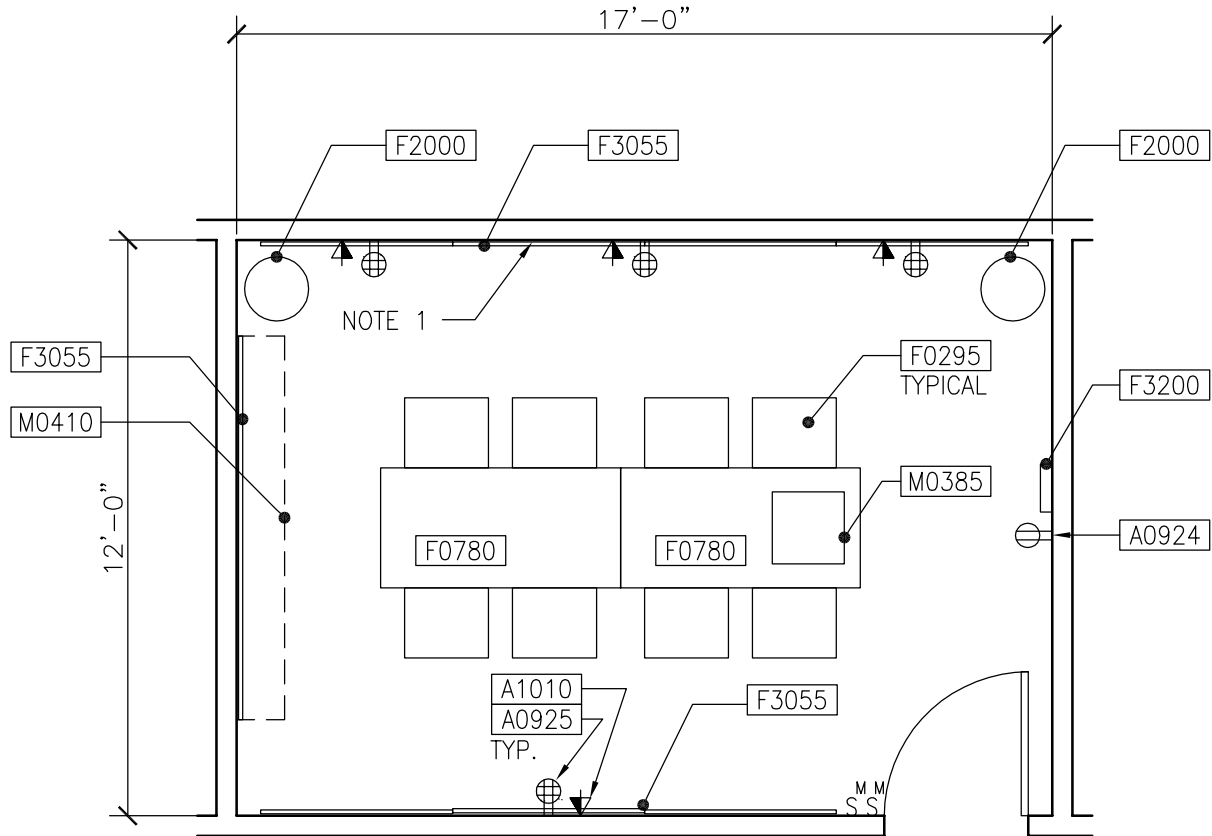

*MINIMUM ROOM SIZE IS 100 NSF. ROOM SHOWN IS BASED ON A FACILITY SIZE OF 300,000 NSF.

SEE DESIGN STANDARDS PAGE OF THIS GUIDE PLATE FOR NUMBERED NOTES.

SEE SECTION 1 FOR SYMBOL LEGEND.

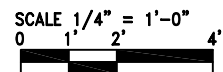

Note: Guide plates are graphical representations of selected room types, illustrating the integration of space, building systems (lights, HVAC, etc), and telecommunications equipment. The Design Team is responsible to perform the calculations to determine final quantities as well as location of each component for every project. Specific infrastructure design requirements are contained in PG 18-5: Equipment Guide List, PG 18-9: Space Planning Criteria, and PG 18-10: Design Manuals (by discipline) located in the VA's Technical Information Library (TIL)

<http://www.cfm.va.gov/TIL/>.

Workroom, Projects (WRCH1)
Reflected Ceiling Plan

200 NSF*
18.6 NSM

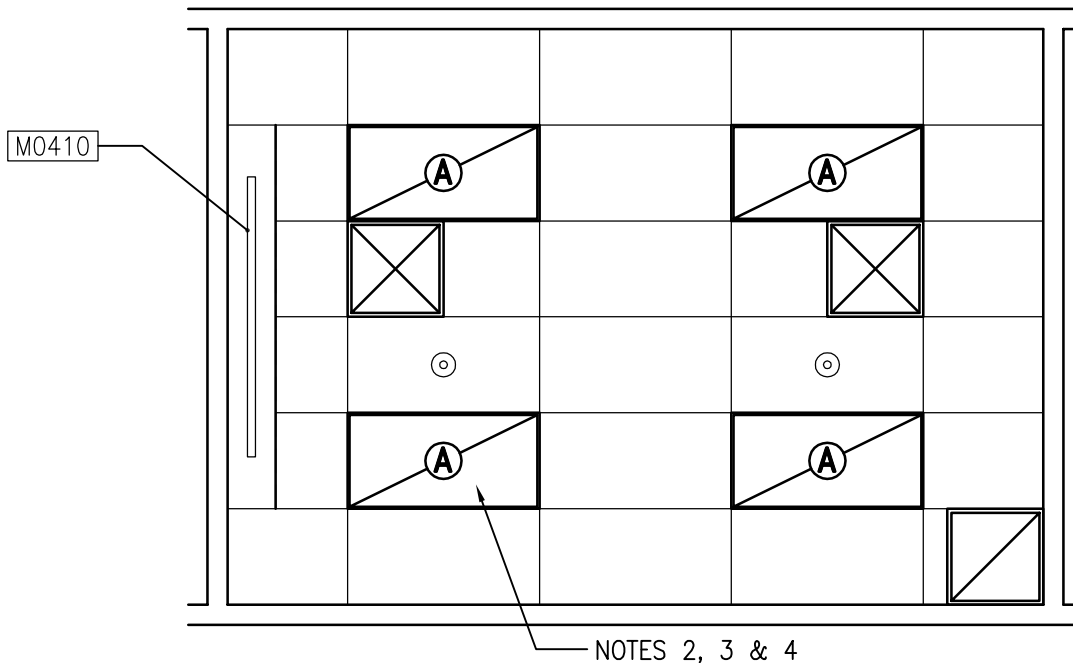

*MINIMUM ROOM SIZE IS 100 NSF. ROOM SHOWN IS BASED ON A FACILITY SIZE OF 300,000 NSF.

SEE DESIGN STANDARDS PAGE OF THIS GUIDE PLATE FOR NUMBERED NOTES.

SEE SECTION 1 FOR SYMBOL LEGEND.

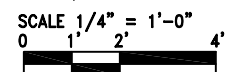

Note: Guide plates are graphical representations of selected room types, illustrating the integration of space, building systems (lights, HVAC, etc), and telecommunications equipment. The Design Team is responsible to perform the calculations to determine final quantities as well as location of each component for every project. Specific infrastructure design requirements are contained in PG 18-5: Equipment Guide List, PG 18-9: Space Planning Criteria, and PG 18-10: Design Manuals (by discipline) located in the VA's Technical Information Library (TIL) <http://www.cfm.va.gov/TIL/>.

Workroom, Projects (WRCH1)

Design Standards

ARCHITECTURAL

Ceiling:	AT
Ceiling Height:	9'-0"
Wall Finish:	GWB-P; Note 1
Wainscot:	--
Base:	RB
Floor Finish:	CP / CPT
Slab Depression:	--
Sound Protection:	STC 40
Doors:	Size S (36"W x 84"H); Type 19/20
Notes:	--
	1) Provide acoustical / tackable wall covering on two walls.

SPECIAL EQUIPMENT

Notes: --

LIGHTING

General:	Refer to <u>Electrical Design Manual</u> .
Special:	--
Notes:	--
	2) 30 average maintained fc illumination level.
	3) Recessed two-lamp fluorescent lighting fixture with acrylic lens and F32T8 lamps, 3500°K, CRI=70 (minimum), dual-level occupancy-sensor switched.
	4) Exact quantity, location, and lamping of fixtures shall be chosen to meet the footcandle requirement.

POWER

General:	Refer to <u>Electrical Design Manual</u>
Emergency:	--
Notes:	--

COMMUNICATION/SPECIAL SYSTEMS

Data:	Yes
Telephone:	Yes
Cable Television:	--
Duress Alarm:	--
Electronic Access and Door Control:	--
Intercom:	--
Motion Intrusion Detection (MID):	--
Nurse Call, Code One (Blue):	--
Public Address:	--
Security Surveillance Television (SSTV)	--
VA Satellite TV:	--
Video Teleconferencing (VTEL):	--
Notes:	--

HEATING, VENTILATING AND AIR CONDITIONING

Inside Design Conditions:	Refer to <u>HVAC Design Manual</u> .
Notes:	--

PLUMBING AND MEDICAL GASES

Cold Water:	--
Hot Water:	--
Laboratory Air:	--
Laboratory Vacuum:	--
Sanitary Drain:	--
Reagent Grade Water:	--
Medical Air:	--
Medical Vacuum:	--
Oxygen:	--
Notes:	--

Workroom, Projects (WRCH1)

Equipment Guide List

JSN	NAME	QTY	AI	DESCRIPTION	SPEC
A1010	Telecommunication Outlet	4	CC	Telecommunication outlet location.	27 15 00
A1016	Telephone, Desk, With Speaker	1	VV	Telephone, desk, with speaker.	
F0295	Chair, Stacking	8	VV	Approximately 34" H x 21" W x 24" D. May be stacked up to 20 high depending upon the model selected. These chairs are intended primarily as overflow capacity for conference rooms.	
F0780	Table, Work, 60"W x30"D	2	VV	Approximately 29"H x 60" W x 30" D with top and four (4) non-folding legs.	
F2000	Basket, Wastepaper, Round Metal	2	VV	Approximately 18" H x 16" diameter. This metal unit is used to collect and temporarily store small quantities of paper refuse in patient rooms, administrative areas and nursing stations.	
F3055	Whiteboard, With Sliding Panels	3	CC	Standard installations consist of sliding panels and a fixed back panel with the choice of chalkboard, markerboard, bulletin board, or a combination of these choices.	10 11 13 10 11 23
F3200	Clock, Battery, 12" Diameter	1	VV	Round surface, easy to read numbers with sweep second hand. Wall mounted unit for use when impractical to install a fully synchronized clock system. Battery operated, (batteries not included).	
M0385	Projector, Multimedia/Data	1	VV	The projector shall provide computer and video projections. Minimum features included: Brightness of not less than 1500 ANSI (American National Standards Institute) Lumens, and a minimum resolution format of 1024 x 768 pixels (XGA). The projector shall be portable and weigh no more than 10 pounds. It shall include a zoom lens and computer and video input ports.	
M0410	Screen, Projection, 70 x 70	1	CC	Projection screen. Ceiling mounted unit, manual pull-down screen. Equipped with grooved roller, a ball bearing mechanical system, and a non-gloss mat white flame retardant and mildew resistant surface. Unit opens with one continuous motion. Designed for classrooms, conference rooms, and auditoriums.	11 52 13
A0924	Receptacle, Electrical, Quadraplex	4	CC	Receptacle, quadraplex, 120 V.	26 27 26
A0925	Receptacle, Electrical, Duplex	1	CC	Receptacle, duplex, 120 V.	26 27 26
				End of Equipment List	

This page intentionally left blank.



Section 5

Appendix

	Page
Index / Cross Reference to Guide Plates Sorted By SEPS Code.....	5-1

This page intentionally left blank.

Index Sorted By SEPS Code

SEPS Space Designation	Functional Area	Space Name	Page
CLR03	FA5: Staff & Administrative Area	Classroom, Computer Training	4-98
FMAE1	FA2: Computer Area	FMS Active Equipment	4-44
FMPE1	FA2: Computer Area	FMS Passive Distribution Equipment	4-38
ITAC1	FA2: Computer Area	HVAC and Electrical Equipment, Computer Area	4-10
ITAD1	FA2: Computer Area	Storage, Active Data	4-58
ITAE1	FA2: Computer Area	OIT IT Active Equipment	4-26
ITBD1	FA3: Computer Support Area	Receiving / Breakdown Room	4-62
ITBU1	FA2: Computer Area	Backup Computer Room	4-4
ITNT1	FA2: Computer Area	Network Operations Room	4-54
ITPE1	FA2: Computer Area	OIT IT Passive Distribution Equipment	4-32
ITRD1	FA3: Computer Support Area	Storage, Temporary Data	4-72
ITWR1	FA3: Computer Support Area	Workroom, Equipment Configuration / Repair	4-66
TEDP1	FA2: Computer Area	Digital Telephone (PBX) Equipment	4-20
TEDR1	FA4: Telecommunications Support Area	Demarc Room	4-80
TEEQ1	FA4: Telecommunications Support Area	Antenna Headend Equipment Room	4-76
TEIP1	FA2: Computer Area	VoIP Active Equipment	4-14
TEOR1	FA4: Telecommunications Support Area	Telephone Operators Room	4-92
TETR1	FA4: Telecommunications Support Area	Telecommunications Room	4-84
WRCH1	FA5: Staff & Administrative Area	Workroom, Projects	4-104

This page intentionally left blank.