

OFFICE OF
INFORMATION
AND TECHNOLOGY

Infrastructure Standard for Telecommunications Spaces (ISTS)

Version 4.0

June 1, 2023 | Infrastructure Operations (IO)

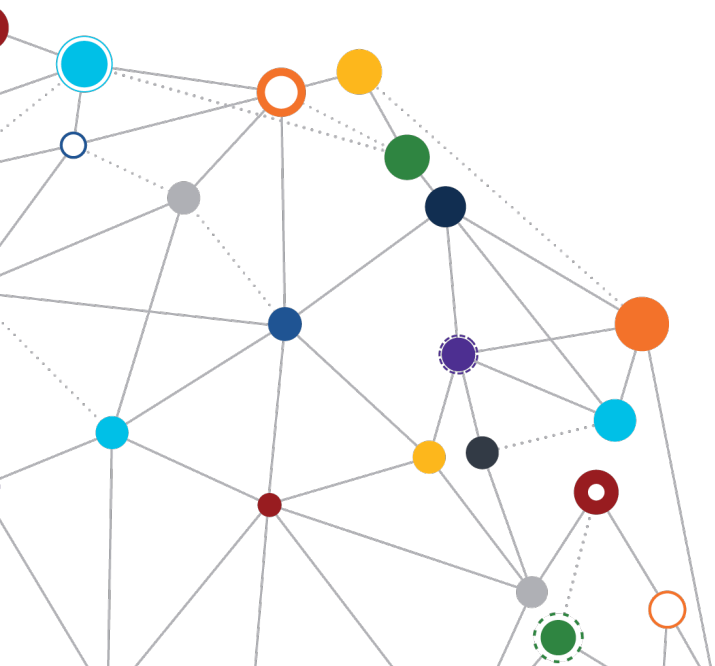

VA



U.S. Department of Veterans Affairs
Office of Information and Technology



Revision History

Table 1: Revision History

Date	Reason for Changes	Version	Author
2007	Original	0.1	Michael Julian, RCDD
2009	Revision	0.2	Michael Julian, RCDD
2012	Revision	1.0	Michael Julian, RCDD
12/07/2016	Enterprise Data Center Infrastructure Collaboration Team (EDICT) Revision	1.1	EDICT
2/05/2018	<ul style="list-style-type: none"> – Expanded revision including the addition of Administrative and Operations Standards – Name changed to include IT Support Infrastructure to reflect broader scope 	1.2	EDICT
6/11/2018	<ul style="list-style-type: none"> – Minor update to allow for deeper network racks in cooperation with IO's request – Expanded allowance for fiber cabinets, cassettes, patch panels, and racks – Changed National Data Center Operations & Logistics (NDCOL) facility ID numbers to VA Record ID numbers – Clarified reference to OIT responsibility for the enterprise-wide technical framework and IT architecture services 	2.1	EDICT
4/10/2019	<ul style="list-style-type: none"> – Name updated from “VA Enterprise Facility IT Support Infrastructure Standard” to “Infrastructure Standard for Telecommunications Spaces” – Minor editorial changes resulting from initial review by the Office of Construction and Facilities Management (CFM) Facilities Standards Service (FSS) for publication in Technical Information Library (TIL) – Removed operational information not required for building planning and design for publishing of the Standard on the TIL. Information redacted will be published as part of the Operations and Maintenance Standards for Telecommunications Spaces. In the interim, refer to the June 11th, 2018 version 2.1 of The Standard on the Baseline Configuration Management (BCM) Standards site. – 508 compliance updates 	2.2	EDICT CFM



Date	Reason for Changes	Version	Author
8/21/2020	<ul style="list-style-type: none"> – Editorial changes resulting from full review by CFM FSS for publication in CFM’s TIL – Updated Telecommunications Room (TR), entrance room, and electrical power standards – Added grounding and bonding, transformers, intra-building/inter-building cabling, lighting, and lightning protection system sections, and Request for Variance process instructions – Created VA-modified Data Center Facility Environment Conditioning Standards figure to replace ASHRAE’s less stringent requirements – Reorganized sequence of chapters for a more logical flow of data center design. Refer to the Table of Contents and the associated links to quickly find any subject of interest – Relocated Figures, Tables, Definitions, References, and Acronyms sections to front matter for consistency with Telecommunication Industry Association (TIA) formats – Added appendices to include Request for Variance form and OIT Design Guide Template Design Package 	3.0	EDICT CFM
7/1/21	<ul style="list-style-type: none"> – 4.2.8 Bonding and Grounding: changed “supplementary” ground path to “dedicated” so it cannot be confused with SBNS, SRGs, Mesh-BNs, etc. – 4.4.4 Fiber Optic Cable: relaxed authorization for Universal Cassettes to be used when breaking out to LC connectors – Appendix B Sheet 2: corrected split package air conditioner heat rejection requirement to be 17,000 BTU/h (5 kW) per rack – Appendix B Sheet 3: corrected layer issue masking attributes and specifications on certain lines in the table – Appendix B Sheet 21: corrected layer issue masking a Power Distribution Units (PDU) on left side of Plate 1 	3.1	EDICT



Date	Reason for Changes	Version	Author
5/1/23	<ul style="list-style-type: none"> – Clarified TR sizing and rack count for small clinical environments and non-medical spaces per serving area – Added Telecommunications Enclosure (TE) specifications – Added antenna entrance room specifications – Added IT Equipment Power Cord section – Harmonized the Environmental Control Equipment Requirements section with the HVAC DM – Added a Fans and Supplemental Airflow Augmentation Device section – Added a Physical Access to Telecommunications Spaces section – Enhanced the Structured Cabling section to differentiate between campus structured cabling and data center structured cabling – Updated the Request for Variance form – Reorganized Appendix B Design Templates into sections to assist with navigation to specific topics; Telecommunications Spaces (Architectural), Telecommunications Enclosure (TE), Electrical Distribution and Bonding, Telecommunications Distribution (Elevations, Cabling, and Routing), and Basis of Design Equipment. – Added sheets for TEs, antenna entrance rooms, Power Distribution Unit (PDU), Uninterruptible Power Supply (UPS), temperature and humidity sensors, horizontal distance study (Diamond Analysis), electrical one-line drawings, cable routing, telecommunications spaces rack elevations, and the rule of thirds. – Added new switch models to the bonding page, clearances around racks and power panels, and separated out the fiber from the copper media into individual sheets. – Changed the light fixtures from 2 ft to 4 ft and replaced the 40 in. Chatsworth Network Cabinet with the Great Lakes Cabinet, and the Chatsworth Terraframe with the ZetaFrame replacement model. 	4.0	EDICT



Table of Contents

Revision History	1
Table of Contents	4
1 Introduction	7
1.1 Purpose.....	7
1.2 Scope.....	7
1.3 Administration.....	7
1.3.1 Request for Variance from Infrastructure Standards.....	8
1.3.2 Request for Change to Infrastructure Standards for Telecommunications Spaces.....	8
1.3.3 Contact Information.....	8
1.4 Standards Overview.....	8
1.4.1 Background.....	9
1.4.2 Future.....	9
1.5 Objectives.....	9
1.6 Authority.....	10
2 IT Support Space Classification	11
2.1 Core Data Centers.....	11
2.2 Mission Support Centers.....	12
2.3 Campus Support Centers.....	12
2.4 Network Support Centers.....	12
3 Information Technology Support Space Planned Redundancy Levels	15
3.1 Core Data Center and Campus Support Center Planned Redundancy Levels.....	19
3.2 Mission Support Center Planned Redundancy Levels.....	21
3.3 Network Support Center, Telecommunications Room, Entrance Room, and Antenna Entrance Room Planned Redundancy Levels.....	23
4 Infrastructure Standards	26
4.1 Architectural Standards and Space Design.....	26
4.1.1 Building Specifications for Common Telecommunications Spaces.....	26
4.1.2 Data Center Layout Standards.....	27
4.1.3 Telecommunications Rooms.....	30
4.1.4 Telecommunications Enclosures.....	33
4.1.5 Entrance Rooms.....	33
4.1.6 Antenna Entrance Rooms.....	34
4.2 Electrical Power and Grounding Standards.....	35
4.2.1 Topology for Power Distribution Standards.....	36
4.2.2 Uninterruptible Power Supply Specifications.....	42
4.2.3 Transformers.....	46
4.2.4 Branch Power Circuit to Rack/Cabinet.....	47
4.2.5 Zone Power Distribution Units.....	48
4.2.6 Rack Mounted Uninterruptible Power Supplies.....	50
4.2.7 Vertical Rack Power Distribution Units.....	52
4.2.8 IT Equipment Power Cords.....	53



4.2.9 Bonding and Grounding.....	55
4.2.10 Lighting.....	63
4.2.11 Metering.....	64
4.3 Mechanical and Environmental Conditioning Standards and Monitoring.....	70
4.3.1 Introduction	70
4.3.2 Environmental Operating Envelope Conditions	70
4.3.3 Data Center Facility Environment Conditioning Standards	72
4.3.4 Data Center Facility Environment Conditioning Standards (Amendments and Exceptions).....	74
4.3.5 Environmental Control Equipment Requirements	76
4.3.6 Airflow Control	79
4.3.7 Monitoring.....	87
4.4 Telecommunications Standards.....	91
4.4.1 Structured Cabling.....	92
4.4.2 Unshielded Twisted Pair.....	94
4.4.3 Unshielded Twisted Pair Patch Panels.....	96
4.4.4 Unshielded Twisted Pair Patch Cord.....	97
4.4.5 Fiber Optic Cable.....	98
4.4.6 Fiber Distribution Cassettes	103
4.4.7 Fiber Patch Cords	104
4.4.8 Fiber Distribution Panel/Cabinet.....	105
4.4.9 Cable Support Infrastructure.....	106
4.4.10 Work Area Outlets.....	108
4.4.11 Horizontal Distribution	109
4.4.12 Fiber Optic Backbone Distribution.....	110
4.4.13 Copper Backbone Distribution.....	111
4.4.14 Server Cabinets.....	112
4.4.15 Network Equipment Racks.....	115
4.4.16 Network Equipment Cabinets.....	117
4.4.17 Telecommunications Enclosure Layout Standards.....	119
5 Administration Standards.....	122
5.1 Data Center Position Identification.....	122
5.1.1 Cross-Reference to Other Identification Systems.....	125
5.1.2 Standardized Data Center Facility Type Identification	125
5.1.3 Standardized Data Center Naming Convention	127
5.2 Information Transport Systems Equipment and Component Labeling.....	129
5.2.1 Label Materials	129
5.2.2 Support Infrastructure Identification.....	132
5.2.3 Transport Media and Interface Identification.....	136
5.2.4 Power Distribution Identification.....	140
5.2.5 Data Communications Cabling Labeling	145
5.2.6 IT Equipment Rack/Cabinet Labeling	147
5.2.7 Power Whip IT Equipment In-Rack/In-Cabinet Power Distribution Labeling.....	147
5.2.8 Power Distribution to IT Labeling.....	147
5.2.9 Physical Label Format	147
5.3 Management Standards	148
5.3.1 Color Coded Identification.....	148



5.3.2 Management of Telecommunications Cabling 149

5.3.3 Management of Airflow 154

5.3.4 Physical Access to Telecommunications Spaces..... 155

5.3.5 Custodial Services..... 155

Appendix A: Request for Variance..... 156

A.1 Request for Variance from Infrastructure Standards 156

A.2 Request for Change to Infrastructure Standards for Telecommunications Spaces..... 156

Appendix B: OIT Design Guide Templates 157

B.1 Design Narrative..... 157

B.2 Main Computer Rooms 157

B.3 Entrance Rooms 158

B.4 Antenna Entrance Rooms 159

B.5 Telecommunications Rooms 159

B.6 Telecommunications Enclosures 160

Appendix C: Figures, Tables, & Other References..... 162

C.1 Figures..... 162

C.2 Tables..... 164

C.3 Definitions..... 166

C.4 References 173

C.5 Acronyms 181

C.6 Contributors 189



1 Introduction

1.1 Purpose

The Infrastructure Standard for Telecommunications Spaces (ISTS) serves as the master reference document of criteria for Department of Veterans Affairs (VA) facility Information Technology (IT) support infrastructure. It defines the technical requirements necessary to maintain optimum reliability and efficiency within VA facilities and computing centers.

1.2 Scope

The ISTS shall be applied to all aspects of IT support infrastructure at all VA owned, operated, and leased spaces. “All aspects” includes, but is not limited to planning, design, construction, sustainment (operations, maintenance, repair), restoration, modernization, and administration. “All VA spaces” includes but is not limited to VA Central Office (VACO) facilities and all field facilities managed by Veterans Health Administration (VHA), Veterans Benefits Administration (VBA), and the National Cemetery Administration (NCA).

IT Support Infrastructure is defined as all passive telecommunications and IT equipment, and supporting physical space and equipment, which includes the following:

- Copper and fiber cabling Information Transport Systems (ITS)
- IT equipment and systems (servers, storage, network switching and distribution, etc.)
- Telecommunications spaces, Telecommunications Rooms (TR), entrance rooms, antenna entrance rooms, data centers, horizontal distribution pathways, vertical distribution pathways, etc.
- Telecommunications equipment and systems (local and wide area network, telephone, cable television, physical security IT system, etc.)
- Physical infrastructure equipment and systems necessary to support active equipment operations at the required availability and sustainability levels (power distribution, environmental conditioning, monitoring and metering equipment, grounding, etc.)

1.3 Administration

The Standard shall be implemented without modification, except when required by an Authority Having Jurisdiction (AHJ), Federal, state, or local laws and codes. Additional requirements of AHJs shall be provided to enterprise Data Center and Infrastructure Engineering (DCIE) for evaluation of project application and possible amendment of the Standard.

Projects in the planning, design, or implementation phases impacting telecommunications distribution, space allocation, layout, electrical distribution, or mechanical systems shall contact DCIE for assistance in telecommunications space design and standards compliance.



Existing IT support infrastructure that does not conform to the ISTS shall be brought into compliance during routine tech refresh, lifecycle replacement, upgrades, new installations, or renovations of existing space.

Facility managers should take every opportunity to bring telecommunications spaces into compliance with the ISTS through incremental changes between scheduled sustainment activities.

Area Managers shall ensure that all contracting officers, IT personnel, and engineering staff are aware and make use of the ISTS.

All staff that routinely access telecommunications spaces require initial basic and annual telecommunications training. Area Managers and supervisors shall assign the approved annual list of OIT telecommunications courses corresponding to the role of the staff member.

1.3.1 Request for Variance from Infrastructure Standards

Requests for variance for allowable deviations from specific requirements of any standards published within may be authorized where a proposed alternate method of installation or operation will provide equal or higher safety, reliability, redundancy, or sustainability objectives. Requests for variance shall be submitted for consideration to DCIE (VAITSEDatacenterEngineering2@va.gov) using a [Request for Variance form](#). If a variance is granted, it shall be limited to the particular site and installation covered in the application and will NOT be considered as a precedent for other installations.

Note: This is a separate process from VHA's process and form for requesting variances from other TIL standards and design manuals.

1.3.2 Request for Change to Infrastructure Standards for Telecommunications Spaces

Requests for changes shall also be submitted to DCIE (VAITSEDatacenterEngineering2@va.gov) for consideration using a [Request for Variance form](#). If approved, the proposed change(s) will be ratified through the Enterprise Baseline and Standard Review (EBSR) process and submitted to the Enterprise Change Advisory Board (CAB) for final approval (if required) before publication.

1.3.3 Contact Information

Transmit all communications to DCIE (VAITSEDatacenterEngineering2@va.gov).

1.4 Standards Overview

The ISTS includes standard specifications, decisions supporting the standard specifications, guidelines, or recommendations for implementing the standard specifications, and supplemental factors to consider when evaluating subject components.



The Infrastructure and the Administration portions of the ISTS define the topologies and specifications for facilities and systems in the VA enterprise.

The Infrastructure Standards also provide guidance on procuring components that meet the standard specifications, guidance on integrating them with existing components, and explanation of how the subject components fit into the VA Enterprise Architecture.

The Administration Standards define the acceptable and recommended specifications for Inside Plant (ISP) naming conventions, including racks, equipment enclosures, fiber and Unshielded Twisted Pair (UTP) transport media, power distribution for active and passive elements, cable plant, and data center naming conventions.

1.4.1 Background

A standard is a set of rules or requirements that are determined by a consensus opinion of subject matter experts and prescribe criteria for a product, process, test, or procedure. The general benefits of a standard are quality, interchangeability of parts or systems, consistency, and reduction of lifecycle costs.

Telecommunications infrastructure standards are based on business needs provided through or supported by IT services. IT services are designed to support business processes and are constructed from software, hardware, and infrastructure components.

Establishing and enforcing standards for the selection and configuration of these supporting components improves the capacity, sustainability, maintainability, reliability, and availability of IT services within projected economic constraints in alignment with business needs.

1.4.2 Future

At the time of this publishing, a separate document, the Operations and Maintenance (O&M) of Telecommunications Spaces Standard is being developed as a companion piece to the Standard. The O&M Standard will describe facility computer room operation specifications, management of telecommunications cabling, and management of airflow.

1.5 Objectives

This Standard provides specifications for use across all VA facilities to support:

- Requirement development
- Solution design
- Solution evaluation
- Solution procurement and bid evaluation
- Evaluation of architectural specifications
- Standardization of passive ISP and Outside Plant (OSP) infrastructure
- Standardization of design criteria for telecommunications spaces, facilities physical infrastructure systems, and operation and maintenance of systems supporting VA services
- Standardization of naming and identification conventions for VA data centers
- Standardization of ISP and rack power infrastructure naming conventions



- Standardization of labeling and identification conventions for physical plant systems and components
- Standardization of operations
- Operational solution procurement and bid evaluation
- Evaluation of maintenance, repair, and replacement specifications
- Standardization of lifecycle sustainment activities across all VA data centers
- Standardization of the operational, organizational, and aesthetic results of Sustainment, Restoration, and Modernization (SR&M) activities

1.6 Authority

Office of Information and Technology (OIT) is the chartered organization responsible for the enterprise-wide technical framework and IT architecture services for VA systems and projects. Centralized responsibility promotes one technology vision across VA, which supports system optimization, integration, and interoperability throughout the enterprise.

One way in which OIT executes this responsibility is determining technical standards for deployed infrastructure technologies. These standards are also known as configuration baselines. The authority of the ISTS derives from the approved enterprise configuration baselines.



2 IT Support Space Classification

VA has four segregated IT Support Space types to support the enterprise distributed computing environment.

- Core Data Centers (CDC) provide enterprise-level support services for VA-wide and cross-component systems and applications.
- Mission Support Centers (MSC) are highly specialized data centers that provide unique, focused services that are best provided from smaller, mission-focused facilities that cannot or should not be supported by CDCs or Campus Support Centers (CSC) due to the direct association MSCs have with mission-specific infrastructure or equipment.
- Campus Support Centers (CSC) operate local data centers to support VA tenants located on a VA campus and within geographically supported areas. CSCs provide services that cannot be provided (technically or economically) from a CDC. Only one CSC is authorized per VA campus.
- Network Support Centers (NSC), provide lower-level application and IT services distribution across the geographic breadth of the VA's computing enterprise, enabling special functions and distributed users to satisfy the specific mission. *Note: Telecommunications Rooms typically follow NSC rating classification and redundancy requirements.*

There shall be a single data center per VA campus. Additional computer rooms used to house and operate IT server or storage equipment are not authorized. This follows with the converged physical telecommunications infrastructure networking model where backbone is distributed from the data center to TRs and other distributed telecommunications spaces, and horizontal distribution supports end-user requirements in the serving zones of these distributed telecommunications spaces. The data center on campus is the only IT support space with the redundancy and resiliency characteristics to support end-user server and storage requirements appropriately.

2.1 Core Data Centers

Core Data Centers (CDC) are facilities that provide shared and distributed enterprise services to supported sites. CDCs host cloud services to provide complete end-to-end IT services (including but not limited to application, backup, and storage) to the supported VA sites.

The CDC architecture is considered mission-essential and is designed, operated, and maintained to provide availability consistent with current VA national data center standards for supported IT applications. CDCs are the target architecture component for IT services that span multiple Department components and user groups (services and applications used by many or all users, such as messaging, productivity, and collaboration).

CDCs may be VA-owned, leased, or government or commercial outsourced (external cloud) data centers. CDCs meet (or are planned to meet) all published CDC physical infrastructure requirements to ensure enterprise reliability, redundancy, high availability, and Disaster Recovery (DR) requirements.



CDCs may also provide services designated to be provided by an NSC if no local NSC to provide those services is available. CDCs may also provide MSC-type application support.

2.2 Mission Support Centers

Mission Support Centers (MSC) provide element-specific and single-instance special enterprise services that may be inappropriate for consolidation to CDC facilities. MSCs are the target architecture for specialized-function systems and applications, particularly those that support a specific but limited local or distributed user group (services allowing the Department to function but with a limited user base such as internal financial management, or applications requiring centralized processing for a small number of user facilities, such as consolidated pharmacies).

MSC physical requirements supporting the computing environment may be more lenient than those for CDCs. Specific requirements will vary based on the supported functions, criticality of the mission, and similar criteria. For example, MSCs designated as enterprise Test and Development environments will not require the same level of high-availability physical and network redundancy as a mission-critical production environment that directly supports patient care.

MSCs may also provide services designated to be provided by an NSC if no local NSC to provide those services is available.

2.3 Campus Support Centers

Campus Support Centers (CSC) provide geographically specific, operational IT services in support of campus services to Veterans and VA employees that cannot be effectively consolidated or provided over cloud architectures to the campus.

CSCs are intended to provide for collocation of IT equipment and systems from all provider organizations including Veterans Affairs Medical Centers (VAMC), VBA Regional Offices, Office of Information Field Office (OIFO), Research & Development (R&D), Police, Security, local Facilities Management Service (FMS), Health Informatics, Clinical Engineering (CE), etc. into the minimum number of operational spaces on a campus; that is, consolidated data centers providing environmental and area network support appropriate to all IT equipment needed by tenant organizations on a particular campus to perform their missions.

CSCs shall provide NSC services for their supported campuses.

2.4 Network Support Centers

Network Support Centers (NSC) provide local IT services that cannot be effectively consolidated or provided over a network-supported distributed architecture to the local operational site. Local means to the immediate facility and to facilities within the local commuting/networking area for the purposes of this architecture; NSCs may provide application support for all VA facilities in a metropolitan area, for example.



An NSC is the appropriate target environment where application architecture and network requirements require a closer data center point of presence to enable end users effective, efficient system access.

Table 2: Data Center Classification Standards

ID	Primary Attribute	Secondary Attribute	Specification
1	Core Data Center (CDC)	Description	CDCs are centralized data centers that provide enterprise-level services to geographically-distributed VA organizations to support business functions. CDCs shall maintain complete High Availability (HA) and DR.
		Planned ANSI/TIA-942-B Rating	3
		Examples	<ul style="list-style-type: none"> Information Technology Center (ITC) Regional Data Center (RDC)
2	Mission Support Center (MSC)	Description	MSCs are stand-alone data centers that provide specific enterprise IT functionality to VA organizations and business functions.
		Planned ANSI/TIA-942-B Rating	2 or 3
		Examples	<ul style="list-style-type: none"> Test/Dev data centers at Rating 2 Centralized Mail Outpatient Pharmacy (CMOP) Consolidated Patient Account Center (CPAC)
3	Campus Support Center (CSC)	Description	CSCs are stand-alone data centers that provide specific IT functionality to a VA campus supporting all VA tenants on that campus and in the geographically supported area.
		Planned ANSI/TIA-942-B Rating	3
		Examples	<ul style="list-style-type: none"> VA Medical Center (VAMC) CBOCs 50,000 ft² and over Health Care Center (HCC)
4	Network Support Center (NSC)	Description	NSCs are local data centers that provide local IT application and network support to local operating locations.
		Planned ANSI/TIA-942-B Rating	1



ID	Primary Attribute	Secondary Attribute	Specification
		Examples	<ul style="list-style-type: none"> • CBOCs under 50,000 ft² • VBA Regional Offices • TRs • Non-healthcare facility entrance rooms (healthcare facility entrance rooms and antenna entrance rooms inherit the Rating 3 redundancy requirements of their CSC) • Other server rooms of limited capacity design (not “shallow rooms”) • Administrative office space server rooms

Evaluation Factors

- Data center facility appropriately and centrally categorized by function and usage
- Capability gaps between existing and planned ANSI/TIA942B Rating requirements identified.



3 Information Technology Support Space

Planned Redundancy Levels

VA IT support spaces shall be designed and operated in accordance with the ANSI/TIA-942-B Ratings for each data center type, except as detailed specifications are provided in this and other VA data center facilities standards.

These specifications define the minimum system redundancy levels for the physical plants and facilities physical infrastructure systems that support enterprise data centers. This Standard shall be used to quantify and qualify designs of physical infrastructure supporting data center facilities and spaces when those spaces are being designed, built, retrofitted, refreshed, and updated.

The minimum design redundancy levels for new and replacement systems in IT support spaces are detailed below. These designs balance system implementation and operation cost against availability needs for each type of space. In planning physical infrastructure system projects, reduction of potential single points of failure is generally considered more critical than increasing the redundancy level of a system.

From a design perspective on a system+system (2N) design, the smaller capacity of the two individual systems is considered the overall system capacity. For instance, a 2N system with a 500 kW side and a 750 kW side has a maximum capacity of 500 kW.

Redundancy is represented relating to the need (N). If no redundancy is required, the system simply has a redundancy level of N. To gain the simplest form of redundancy, one additional system is added represented by N+1. For example, if two Computer Room Air Conditioners (CRAC) are needed to meet the cooling need of the data center, then to obtain an N+1 redundancy level a third CRAC must be added. To provide further redundancy a 2N system could be put in place. In the CRAC example, four CRACs would create a 2N system. Furthermore, for a 2N+1 system, five CRACs would be required to meet this level of redundancy. Finally, for a 2(N+1) system, six CRACs would be required.



Implementation Guidance

Where N+C redundancy is required for environmental control systems in CDCs, be aware that design considerations including total number and capacity of CRAC units, spacing of units in planned designs, and geometries of computer room spaces may dictate that one, two, three, or more units more than the N requirement may be necessary to ensure appropriate environmental control in all contingency situations. Computational Fluid Dynamics (CFD) modeling is required to understand the airflow and determine the effect of teaming various combinations of CRAC units and adjustment of settings.





Redundancy Level	Generic System Diagram
N	*  * 1k or 500 500
N+1	 500 500 500 or 250 250 250 250 250
2N	 1k 1k or 500 500 500 500
2N+1	 1k 1k 1k or 500 500 500 500 500
2(N+1)	 1k 1k 1k 1k or 500 500 500 500 500 500
*Circled loads are active.	

Figure 1: Generic Redundancy Level Standards for Physical Plants, Facilities, and Infrastructure Systems



Table 3: Data Center Planned Redundancy Levels

ID	Primary Attribute	Secondary Attribute	Specification
1	Facility Power Input Sources	Core Data Center (CDC)	N+1 redundant feed: one commercial power source (also known as utility), one generated power (also known as emergency)
		Mission Support Center (MSC)	N+1 redundant feed (one commercial, one generated) for a Rating 3 facility or single feed (N) for a Rating 2 facility
		Campus Support Center (CSC)	N+1 redundant feed (one commercial, one generated)
		Network Support Center (NSC)	N (one commercial)
2	Emergency Power Generation Source	Core Data Center (CDC)	N+1
		Mission Support Center (MSC)	N for Rating 2 facility and N+1 for Rating 3 facility.
		Campus Support Center (CSC)	N+1
		Network Support Center (NSC)	<ul style="list-style-type: none"> • Provide emergency power to TRs IAW the VA Electrical Design Manual when supporting medical center with a CSC • Not required but recommended to support other medical and non-medical facilities
3	Uninterruptible Power Supply (UPS) Technical Power Systems	Core Data Center (CDC)	2N
		Mission Support Center (MSC)	N+1 (distributed redundant modules or block redundant system with dedicated battery string for each module)
		Campus Support Centers (CSC)	2N
		Network Support Center (NSC)	N (single UPS system, single battery string)
4	Electrical Distribution (UPS to IT equipment)	Core Data Center (CDC)	2N (mirrored A/B distribution from UPS to rack in support of all IT systems)



ID	Primary Attribute	Secondary Attribute	Specification
		Mission Support Center (MSC)	2N (mirrored A/B distribution from UPS to rack in support of all IT systems)
		Campus Support Center (CSC)	2N (mirrored A/B distribution from UPS to rack in support of all IT systems)
		Network Support Center (NSC)	N
5	Environmental Support (HVAC)	Core Data Center (CDC)	<ul style="list-style-type: none"> • N+1. If more than five CRACs, then N+C where C=1 for every five to eight CRACs needed • Brief interruptions to electrical power (<10 min) will not cause loss of cooling but may cause temperature to elevate within operational range of critical equipment
		Mission Support Center (MSC)	<ul style="list-style-type: none"> • N+1 • Brief interruptions to electrical power (<10 min) will not cause loss of cooling but may cause temperature to elevate within operational range of critical equipment
		Campus Support Center (CSC)	<ul style="list-style-type: none"> • N+1 • Brief interruptions to electrical power (<10 min) will not cause loss of cooling but may cause temperature to elevate within operational range of critical equipment
		Network Support Center (NSC)	N



3.1 Core Data Center and Campus Support Center Planned Redundancy Levels

Table 4: Core Data Center and Campus Support Center Planned Redundancy Levels

ID	Primary Attribute	Secondary Attribute	Specification
1	Facility Power Input Sources	System Redundancy Components	N+1 redundant feed (one commercial, one generated)
		Distribution Paths	One active, one standby (one commercial feed, one standby generation, Automatic Transfer Switch (ATS))
		System (N) Capacity	Total facility design capacity (either commercial feed or generator can provide 100 % of the facility’s design load)
2	Emergency Power Generation Source	System Redundancy Components	N+1
		Distribution Paths	Single path ATS
		System (N) Capacity	Total facility design capacity (generator source can provide all critical mechanical and electrical support for the facility)
3	UPS Technical Power Systems	System Redundancy Components	2N
		Distribution Paths	Two simultaneously active (A/B configuration)
		System (N) Capacity	<ul style="list-style-type: none"> Each UPS system (A/B) rated for 100 % of data center design load Modular systems sized for ultimate design load but only populated to current load needs is preferred
		UPS Technology	Two delta conversion or double conversion UPS systems
4	Electrical Distribution (UPS to IT equipment)	System Redundancy Components	2N (mirrored A/B distribution from UPS to rack in support of all IT systems)
		Distribution Paths	Two simultaneously active (A/B distribution from UPS)
		System (N) Capacity	Maximum design loading of all components with one distribution path offline



ID	Primary Attribute	Secondary Attribute	Specification
5	Environmental Support (HVAC)	System Redundancy Components	<ul style="list-style-type: none"> • N+1. If more than five CRACs, then N+C where C=1 for every five to eight CRACs needed • Brief interruptions to electrical power (<10 min) will not cause loss of cooling but may cause temperature to elevate within operational range of critical equipment
		Redundancy Configuration	One alternate
		Power Source	<ul style="list-style-type: none"> • Each CRAC and its associated heat rejection equipment for that CRAC powered from the same source • Sets of heat rejection systems diversely powered (from differing sources) • Design power sources to provide maximum reasonable avoidance of single points of failure
		System (N) Capacity	Total facility design capacity

Implementation Guidance

Uninterruptible Power Supply (UPS) systems shall be sized for the ultimate design load of the telecommunications space. For initial cost, maintenance, reliability, and efficiency reasons, modular UPS systems built out to provide sufficient UPS and battery capacity to meet near-term requirements are preferred over full-capacity systems.

Both the A/B UPS systems shall be powered from generator-backed sources.



3.2 Mission Support Center Planned Redundancy Levels

Table 5: Mission Support Center Planned Redundancy Levels

ID	Primary Attribute	Secondary Attribute	Specification
1	Facility Power Input Sources	System Redundancy Components	N+1 Redundant Feed (one commercial, one generated) for a Rating 3 facility or Single feed (N) for a Rating 2 facility
		Distribution Paths	One active, one standby (one commercial utility feed, one standby generation, ATS)
		System (N) Capacity	Total facility design capacity (either source can provide 100 % of the facility's design load)
2	Emergency Power Generation Source	System Redundancy Components	<ul style="list-style-type: none"> • N+1 for a Rating 3 facility • N for a Rating 2 facility
		Distribution Paths	Single path ATS
		System (N) Capacity	Total facility design capacity (generator source can provide all critical mechanical and electrical support for the facility) for a Rating 3 facility or sized for UPS and mechanical system without redundancy for a Rating 2 facility
3	UPS Technical Power Systems	System Redundancy Components	N+1 (distributed redundant modules or block redundant system with dedicated battery string for each module)
		Distribution Paths	Two simultaneously active (A/B configuration)
		System (N) Capacity	<ul style="list-style-type: none"> • Each UPS system (A/B) rated for 100 % of data center design load • Modular systems sized for ultimate design load but only populated to current load needs are preferred
		UPS Technology	Delta conversion or double conversion UPS systems
4		System Redundancy Components	2N (mirrored A/B distribution from UPS to rack in support of all IT systems)



ID	Primary Attribute	Secondary Attribute	Specification
	Electrical Distribution (UPS to IT equipment)	Distribution Paths	<ul style="list-style-type: none"> Two simultaneously active (A/B distribution from UPS systems to Power Distribution Units (PDU) to the Master Power Distribution Unit (MPDU)) Redundant, diverse path, and follows rectilinear pathways when not contained in a cable tray
		System (N) Capacity	5 kW capacity for each enclosure
5	Environmental Support (HVAC)	System Redundancy Components	<ul style="list-style-type: none"> N+1 Temporary loss of electrical power will not cause loss of cooling, but may cause temperature to elevate within operational range of critical equipment for a Rating 3 facility or N+1 redundancy for mechanical equipment) Loss of electrical power can cause loss of cooling in a Rating 2 facility
		Redundancy Configuration	One alternate
		Power Source	<ul style="list-style-type: none"> Each CRAC and its associated heat rejection equipment for that CRAC powered from the same source Sets of heat rejection systems diversely powered (from differing sources) Design power sources to provide maximum reasonable avoidance of single points of failure
		System (N) Capacity	Total facility design capacity

Implementation Guidance

UPS systems shall be sized for the ultimate design load of the telecommunications space. For initial cost, maintenance, reliability, and efficiency reasons modular UPS systems built out to provide sufficient UPS and battery capacity to meet near-term requirements are preferred over full-capacity systems.

Both the A/B UPS systems shall be powered from generator-backed sources (for Rating 3 facilities).



3.3 Network Support Center, Telecommunications Room, Entrance Room, and Antenna Entrance Room Planned Redundancy Levels

Note: Healthcare facility entrance rooms and antenna entrance rooms inherit the TIA-942-B Rating 3 redundancy requirements of the CSC data center facility that they support.

Table 6: Network Support Center, Telecommunications Room, Entrance Room, and Antenna Entrance Room Planned Redundancy Levels

ID	Primary Attribute	Secondary Attribute	Specification
1	Facility Power Input Sources	System Redundancy Components	N (one commercial)
		Distribution Paths	One path
		System (N) Capacity	Total facility design capacity (commercial feed can provide 100 % of the facility’s design load)
2	Emergency Power Generation Source	System Redundancy Components	<ul style="list-style-type: none"> • N+1 when supporting medical center with a CSC, not required, but recommended supporting other medical facilities and non-medical facilities • N required at all sites with facility generation capabilities
		Distribution Paths	<ul style="list-style-type: none"> • Minimum one path when supporting medical center with a CSC, not required, but recommended supporting other medical facilities and non-medical facilities • N required at all sites with facility generation capabilities
		System (N) Capacity	When provided, based on planned facility ultimate load
3	UPS Technical Power Systems	System Redundancy Components	<ul style="list-style-type: none"> • N (single UPS system, single battery string; may be individual rack-mount UPS systems for each rack) for NSCs and TRs • N for entrance rooms supporting NSCs and Rating 2 MSCs • 2N for entrance rooms and antenna entrance rooms supporting CSCs, CDCs, and Rating 3 MSCs



ID	Primary Attribute	Secondary Attribute	Specification
		Distribution Paths	<ul style="list-style-type: none"> • One path • Two simultaneously active (A/B configuration) for entrance rooms and antenna entrance rooms supporting CSCs, CDCs, and Rating 3 MSCs
		System (N) Capacity	<ul style="list-style-type: none"> • UPS system(s) rated for 100 % of critical IT system design load (5 kW per enclosure) • Modular systems sized for ultimate design load but only populated to current load needs are preferred
		UPS Technology	<ul style="list-style-type: none"> • Rack-mounted line interactive UPS systems (mechanical ATS optional) • Facility UPS
4	Electrical Distribution to IT equipment	System Redundancy Components	<ul style="list-style-type: none"> • 2N • A side shall be UPS-backed, B-side may be commercial • 2N both sides UPS-backed for entrance rooms and antenna entrance rooms supporting CSCs, CDCs, and Rating 3 MSCs
		Distribution Paths	Two paths simultaneously active (A/B configuration)
		System (N) Capacity	5 kW capacity for each enclosure
5	Environmental Support (HVAC)	System Redundancy Components	<ul style="list-style-type: none"> • N • N+1 for entrance rooms and antenna entrance rooms supporting CSCs, CDCs, and Rating 3 MSCs
		Redundancy Configuration	<ul style="list-style-type: none"> • None • One alternate for entrance rooms and antenna entrance rooms supporting CSCs, CDCs, and Rating 3 MSCs
		System (N) Capacity	Requirement varies based on the number of racks

Implementation Guidance

UPS systems shall be sized for the ultimate design load of the telecommunications space. For initial cost, maintenance, reliability, and efficiency reasons modular UPS systems built out to provide sufficient UPS and battery capacity to meet near-term requirements are preferred over



full-capacity systems. Modular UPS systems may not be available to meet rack-mounted applications.

Healthcare facility entrance rooms and antenna entrance rooms inherit the TIA-942-B Rating 3 redundancy requirements of the CSC data center facility that they support.



4 Infrastructure Standards

4.1 Architectural Standards and Space Design

VA telecommunications spaces, including entrance rooms, antenna entrance rooms, TRs, and data centers shall be designed and operated in accordance with the ANSI/TIA-942-B ratings for each data center classification, except as detailed specifications are provided in this and other VA data center facilities standards.

4.1.1 Building Specifications for Common Telecommunications Spaces

Table 7: Building Specifications

ID	Primary Attribute	Secondary Attribute	Specification
1	Shell	Security	As per Physical Security and Resiliency Design Manual (PSRDM)
		Access Route	Leads to location outside computer room for access control
		Egress	Observes life safety code
		Door Height (telecommunications spaces)	8 ft minimum
		Door Height (Mechanical Room)	9 ft minimum
		Door Width	<ul style="list-style-type: none"> CSC, CDC, and MSCs- A 6 ft double doorway opening is required with or without a mullion. If center mullion is used, it must be removable. NSC- 3 ft (nominal)
		Finished Floor to Lowest Structural Obstacle (clear space)	12 ft minimum
		Slab to Floor Above (MSC, CSC, CDC)	16 ft minimum
		Raised Floor (in new data center construction only if CFD analysis determines raised floor is the best cooling solution)	<ul style="list-style-type: none"> 24 in. minimum above slab Height determined by CFD analysis



ID	Primary Attribute	Secondary Attribute	Specification
		Floor Surface	<ul style="list-style-type: none"> • Electrostatic Discharge (ESD) coating for raised floor systems • Static dissipative coating or material for slab floors
		Bonding	Per manufacturer requirements
		Backboard	<ul style="list-style-type: none"> • 4 ft x 8 ft AC grade ¾ in. trade size fire-rated plywood backboard painted high-gloss white with two coats of fire-resistant paint for service provider/security/video/etc. around three perimeter walls of TRs, entrance rooms, antenna entrance rooms, and as required for computer rooms • Reserve an additional 12 in. dedicated space from backboards to accommodate equipment mounted on them
2	Raised Floor Tile	Dimensions	24 in. x 24 in. nominal
		Standard Tile	Placed by default everywhere perforated tiles and grates are not required by CFD
		Perforated Tile, High-Capacity Grates, and other High Airflow Tiles	<ul style="list-style-type: none"> • Only placed in the cold aisle in front of equipment inlets where CFD modeling predicts the optimum effectiveness • Positioned so that tiles are flush to the front of the row with directional airflow aimed towards the air inlets on IT equipment in the racks • Can be removed without interference from racks or cabinets

4.1.2 Data Center Layout Standards

Data centers will be designed in accordance with the specifications below, VA standards, and industry best practices listed in References.

CFD modeling shall be used to determine the most effective and cost-effective layout and containment solution for a given space (including new design/build, capability expansion, and lifecycle replacement). All data center designs for new data centers, expansion, or significant modification of existing data centers shall be approved through DCIE (VAITSEDatacenterEngineering2@va.gov).

Airflow separation of hot and cold air shall be a prime consideration when designing the floor layout and when selecting and procuring IT equipment. Equipment shall be specified, procured, configured, and installed so that the equipment draws cool air from the front face of the rack



and flows from the front of the rack to the rear or top of the rack and exiting either the rear door of the rack or the top through a Vertical Exhaust Duct (VED). Do not create conditions for exhaust to be recirculated back into cold air supply spaces.

Table 8: Data Center Floor Layout Standards

ID	Primary Attribute	Secondary Attribute	Specification
1	Aisles	Orientation	<ul style="list-style-type: none"> • Front of racks will be oriented toward cold aisle as in Figure 2 below • Front of racks will be aligned with each other to create a continuous linear aisle • If a raised access floor is used, front of racks will be flush with edge of floor tiles
		Width	<ul style="list-style-type: none"> • 4 ft minimum in cold aisles • 3 ft minimum in hot aisles (4 ft recommended)
		Cold Aisle	<ul style="list-style-type: none"> • Power cords if run in an access floor (with data cabling) will be placed in cable trays in cold aisles • Overhead power cords can be run either in the hot or cold aisles
		Hot Aisle	<ul style="list-style-type: none"> • Data cables if run in an access floor will be placed in cable trays in hot aisles • Power cords if run in an access floor (where data cabling is run overhead) will be placed in the hot aisle • Overhead power cords can be run either in the hot or cold aisles • Busways will be placed in the hot aisles
		Containment	Hot or cold aisle containment will be determined based on data center layout, HVAC configuration, and CFD analysis
2	Support Equipment	Computer Room Air Conditioners (CRAC)	Placement determined using CFD analysis
		Floor Stands	Manufacturer recommended floor stands for heavy equipment when raised access floor is used
		Power Distribution Units (PDU)	<ul style="list-style-type: none"> • Floor mounted PDUs are not to be placed within cold aisles • A-side and B-side PDUs will be aligned in a regular order to indicate power source



ID	Primary Attribute	Secondary Attribute	Specification
		Branch Circuit Panelboards (BCP) (also known as Remote Power Panels (RPP))	<ul style="list-style-type: none"> • Not to be placed within cold aisles • A-side BCP/RPPs aligned in a row • B-side BCP/RPPs aligned in a row
		Uninterruptable Power Supplies (UPS)	Placed in separate dedicated spaces or within the computer room IAW CFD
3	Equipment Rows	Length	No more than 14 racks/cabinets per row
		Orientation	No rows that terminate along a wall
		Cabinet/Rack/Cooling/PDU/RPP Placement	<ul style="list-style-type: none"> • End of row racks or network cabinets shall be used for the Horizontal Distribution Area (HDA) to accommodate structured cabling • Gaps between adjacent racks and cabinets within each row are closed to eliminate internal paths of bypass and recirculation of air flows • Equipment cabinets will be used between the HDAs
		Clearance	<ul style="list-style-type: none"> • Ensure 3 ft minimum clearance from the front, back, and one side of each rack row to walls. The fourth side must not abut a wall and needs to leave 12 in. clearance • 4 ft minimum (6 ft recommended) distance from air conditioning and power distribution equipment (does not apply to in-row cooling/PDUs/RPPs) • Per manufacturer requirements • Per AHJ for egress



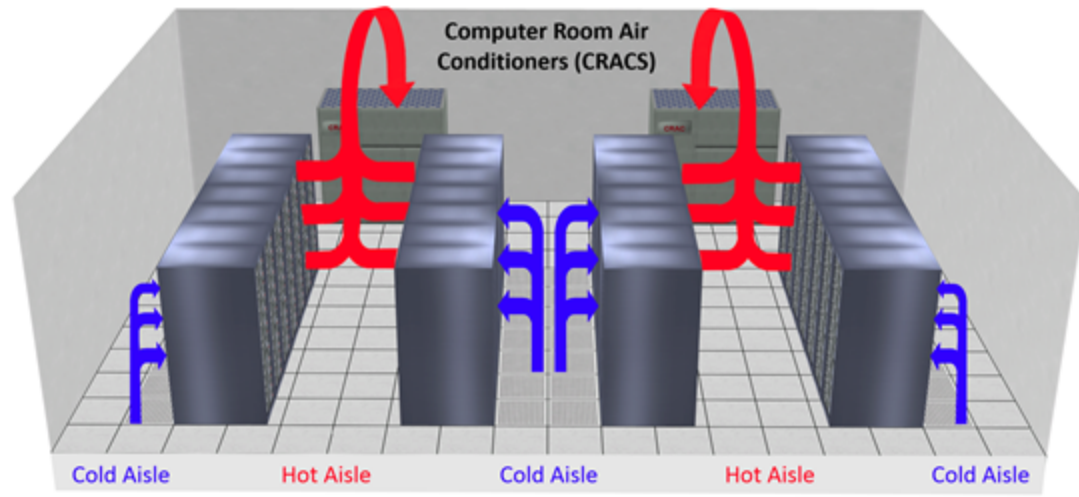

Figure 2: Hot Aisle/Cold Aisle Approach

Implementation Guidance

This Standard applies to new data center and telecommunications space construction as well as expansion, modification, and operation of existing facilities.

Engineered floor stands are required for CRACs, UPS battery cabinets, and other equipment capable of causing floor loading issues in raised floor environments.

VA shall not design or build “shallow rooms” or similar small spaces. Shallow rooms are intended only for access to vertical chases and riser cables installed there. Where a distribution TR is necessary in a location (i.e., the third floor of the west wing of a hospital), VA shall construct and operate out of a standardized TR.

4.1.3 Telecommunications Rooms

Telecommunications Rooms (TR) are a subset of the NSC classification archetype with less stringent environmental control requirements that:

- Serve as the transition point between the horizontal and backbone cabling systems
- Contain all networking, security, video distribution, paging, and any other system that serves the TR zone

There shall only be a single TR per serving zone. Additional TRs (or similar) are not authorized to support specific functions (e.g., FMS or CE). Likewise, TRs shall not be physically split or divided to separate organizational functions or for physical security purposes and shall not be designed, implemented, or operated. This follows with the converged physical telecommunications infrastructure networking model where backbone is distributed from the data center to TRs and other distributed telecommunications spaces and horizontal distribution supports end-user requirements in the serving zones of these distributed telecommunications spaces. The TR is the only IT support space in the serving zone that is supplied with backbone media suitable to support IT and IT-like system functions and designed with the redundancy and resiliency characteristics to support end-user equipment requirements appropriately.

Few TRs are exactly alike. OIT shall design or conduct design reviews of all projects involving new or renovated TRs to assure that the power, cooling, and room layout are consistent with VA and industry standards.

Evaluation Factors

- Floor area served
- Number of active Work Area Outlets (WAO) served
- Horizontal distribution distance

Implementation Guidance

Telecommunications Rooms for facilities providing healthcare (medical centers) shall be 170 ft² with a standard 4-rack configuration as shown in Appendix B. Provide approximately 2 ft linearly for each additional rack after four by extending the length of the TR for each rack required.

For non-medical spaces, TR sizing is dictated by the maximum quantity of *active* WAOs (the horizontal distribution cables that are patched to a switch port, actively supporting an end-user device) that can be operated in the TR (this aligns with the maximum quantity of 48-port switches that can be supported out of a TR of a given number of racks) in the supported serving zone.

In smaller clinical environments (e.g., CBOCs), smaller TRs may be specified: The more restrictive of the following two tables (serving area size and work area outlet count) will be used to determine TR sizing in smaller clinical environments (e.g., CBOCs) and non-medical spaces.

Table 9: Small Clinical Environment Racks and Telecommunications Room Sizing per Serving Area

ID	Primary Attribute	Secondary Attribute	Specification
1	Serving Area Size	< 6,000 ft ²	1-rack TR (80 ft ² , 10 ft x 8 ft form factor)
		6,001-10,000 ft ²	2-rack TR (100 ft ² , 10 ft x 10 ft form factor)
		10,001-25,000 ft ²	3-rack TR (120 ft ² , 10 ft x 12 ft form factor)
		> 25,000 ft ²	4-rack TR (170 ft ² , 10 ft x 12 ft form factor)



Table 10: Non-medical Space Racks and Telecommunications Room Sizing per Active Work Area Outlet Density in Supported Serving Zone

ID	Primary Attribute	Secondary Attribute	Specification
1	WAOs*	< 96 WAO	Telecommunications Enclosure (when meeting other TE criteria)
		< 144	1-rack TR (80 ft ² , 10 ft x 8 ft form factor)
		145-240	2-rack TR (100 ft ² , 10 ft x 10 ft form factor)
		241-480	3-rack TR (120 ft ² , 10 ft x 12 ft form factor)
		> 480	4-rack TR (140 ft ² , 14 ft x 10 ft form factor)

**Maximum quantity of active WAOs (the horizontal distribution cables that are patched to a switch port, actively supporting an end-user device) that can be operated in the TR (this aligns with the maximum quantity of 48-port switches that can be supported out of a TR of a given number of racks) in the supported serving zone.*

Ensure minimum clearance around racks and equipment:

- 3 ft distance clearance from the front, back, and one side of each rack row to TR walls. The fourth side must not abut a wall and needs to leave 12 in. clearance.
- Provide an additional 12 in. dedicated space on backboards to accommodate service provider, security, video, etc. equipment mounted on them.
- Provide an additional 30 in. wide by 36 in. front clearance required around electrical panel boards.

VA shall not design, build, or use "shallow rooms" or similar small spaces for TRs. Where existing shallow rooms are used for telecommunications cabling, they shall only be used for access to vertical chases and riser cabling pass-through installed there. No active or passive network equipment, power requirements, or environmental considerations are required.

There shall be a minimum of one standardized TR per floor. Generally, additional standard TRs should be provided:

- When the horizontal distribution distance to the work area exceeds 295 ft (90 m)
- Recommended when the horizontal distribution distance to the work area exceeds 262 ft (80 m)

IT, networking, and special telecommunications equipment from all facility users should be specified as 19 in. rack-mountable (or installed on 19 in. shelves) and installed in the network racks provided in the TR for this purpose. The installation of separate vendor-provided wall-mounted racks for this equipment is not authorized. Space on the backboard is reserved for systems that cannot be rack-mounted (e.g., enclosures for proprietary security system components, fire protection system enclosures).



See Appendix B:: OIT Design Guide Templates for additional design considerations.

4.1.4 Telecommunications Enclosures

These specifications define a standardized Telecommunications Enclosure (TE) for use in specific limited circumstances where a standard TR is not feasible or warranted.

Evaluation Factors

- Number of WAO served
- Installation environment

Implementation Guidance

Space classification. Telecommunications Enclosures (TE) may be deployed to the following types of non-healthcare spaces (any space below may also be granted a variance to use a TR less than 80 ft² as long as the excepted clearance requirements are maintained and the maximum of 96 WAOs is not exceeded):

- Parking structures
- Technical spaces such as warehouses, kitchens, laundries, mechanical/electrical plant buildings, chiller or boiler plants, garages, and paint shops
- Historical quarters converted to administrative use
- Buildings with no or limited VA staffing presence and limited connectivity requirements such as gyms, auditoriums, chapels, etc.
- Temporary modular trailers (Temporary buildings and trailers must be validated to be actually temporary, with a planned date of removal and no history of previously deferred or canceled removal plans)
- NCA field facilities
- Fisher House buildings
- VHA mental health administration facilities (veterans centers)

See Section 4.4.17 Telecommunications Enclosure Layout Standards for selection criteria, salient characteristics, and enclosure level implementation guidance.

4.1.5 Entrance Rooms

Entrance rooms are a subset of the NSC classification archetype with less stringent temperature range requirements. Entrance rooms have the additional requirement of matching the electrical distribution and heat rejection redundancy requirements of the computer room that they support.

Entrance rooms are the entrance to a building where both public and private network service cables and equipment (including wireless) interface with the data center cabling system. Usually this is the demarcation point where operational control or ownership changes, typically between the service provider and the customer.

In new construction, the entrance rooms require special consideration for earlier beneficial occupancy than other building functions. Plan completion of construction and outfitting of



entrance rooms to occur earlier in projects than for other telecommunications spaces. Entrance room outfitting must be complete by the time that carrier circuits and carrier equipment from service providers are brought onto campus, allowing other systems to be tested and commissioned.

Entrance rooms will have similar features as TRs including backboard, racks, power, and cable management. DCIE shall design or conduct design reviews of all projects involving new or renovated entrance rooms to assure that the power, cooling, and room layout are consistent with VA and industry standards.

Entrance rooms shall be a minimum of 80 ft² for a one-rack entrance room and an additional 20 ft² for each additional rack required.

Two entrance rooms are required for each VA campus supported by a CDC or CSC. These are typically located in the same building as the computer room serving the campus. Where two entrance rooms are required to support the diverse providers (for CDCs and CSCs), they must be located at least 66 ft (20 m) apart.

On smaller VA campuses (including stand-alone buildings) supported by a single telecommunications space, the entrance room can be collocated in that space.

Additional buildings on the campus will not have entrance rooms. Cable plant media is routed directly from the campus data center to each TR in each additional building on campus. VA does not use building distributors, which would be individual entrance rooms for buildings and would be, in effect, intermediate cross-connects for the cable plant media.

Entrance points must be within 50 ft (15 m) of the OSP entrance point duct bank to allow for transition from OSP to ISP cabling.

Health care facility entrance rooms shall be a minimum of 170 ft². If more than four racks are required than an additional 20 ft² per additional rack must be added to the design.

Evaluation Factors

Number of telecommunications providers

Implementation Guidance

A TR or equipment room (computer room) may serve as an entrance room.

Develop diverse building entrance routes when more than one access provider serves a building so a catastrophic failure along one entrance route will not interrupt the entirety of a building's telecommunications service.

See Appendix B: for additional design considerations.

4.1.6 Antenna Entrance Rooms

Antenna entrance rooms are a subset of the NSC classification archetype (and entrance room function) with less stringent temperature range requirements. Antenna entrance rooms are the telecommunications entrance room for roof-mounted antenna, microwave, satellite dish, and



other telecommunications services mounted at the roof level. They accommodate all provided and planned Radio Frequency (RF) based systems and headend equipment cabinets housing cellular reinforcement Distributed Antenna System (DAS), Master Antenna Television (MATV), Television Receive Only Master Antenna Satellite Television (TVRO), Very Small Aperture Terminal (VSAT), High Frequency (HF), microwave, Radio Entertainment Distribution (RED), Public Address (PA), Two-Way Radio, Radio Paging System (RPS), and Video Surveillance Systems (VSS) including Closed Circuit Television (CCTV), Security Surveillance Television (SSTV), etc. This room will have the same TIA-942 rating as lower entrance rooms, but will have additional power, racks, and bonding to support the associated carrier and radio equipment. Where feasible, all signal amplifiers, carrier equipment, cellular transceivers, etc. for intrabuilding DAS and public access cellular service should be installed in this entrance room.

Evaluation Factors

- Number of antennas
- Type and quantity of media
- Number of Service Providers
- Supported services

Implementation Guidance

- 300 ft² conditioned room with two rows of five telecommunications racks
- Redundant 5000 VA UPS systems to supply fully redundant backup power for a 5 kW load
- One PBB sized bonding busbar to support the room
- One SBB sized bonding busbar behind each rack to support carrier bonding
- A minimum of four trade size 5 (data center) with a minimum of two trade size 4 conduits
- Intrabuilding backbone conduits must be installed with a minimum of four in. extending AFF to prevent down flooding
- All penetrations are to be weatherproof
- All conduit to be outfitted with mechanical firestop protection (no clay or pillows)
- ESD flooring to be bonded to the main SBB in this room
- All racked equipment to be bonded to nearest busbar
- Basket-type cable tray around the perimeter to be bonded
- Ladder-type cable vertical wall-mounted tray to be bonded

4.2 Electrical Power and Grounding Standards

These specifications define a standardized power distribution from branch distribution panel equipment to the active IT equipment enclosure with sufficient power to energize up to 5 kW redundantly in a Standard Density (SD) configuration, or up to 10 kW redundantly in a High Density (HD) configuration. This approach allows the facility engineer to provide a standardized branch circuit (3-phase 60 A) through legacy facilities for the majority of server, LAN, and storage stacks. Proprietary and equipment-specific power requirements shall be avoided.

This standardized approach creates consistency throughout the data center and reduces overall power complexity. Ultimately, this approach will reduce the capital costs of installing new



equipment and the operation costs by reducing or eliminating the need to change branch circuits with each IT equipment refresh. The Minimum Circuit Ampacity (MCA) in IT support spaces, for both critical and convenience distribution, is 20 A. All circuits supporting IT support spaces shall be sized (breaker, conductor, and receptacle equipment) at 20 A or larger.

Electrical distribution in the data center shall be redundant on diverse paths and follow rectilinear pathways when not contained in a cable tray.

Headends for A/B electrical paths to distribution devices (busway headends, PDUs, etc.) follow different paths for physical path redundancy.

Why did the Electrical Power and Grounding Standards change?

The previous standards for power distribution specified 30 A 3-phase distribution deployed through a 30 A redundant zPDU. This topology was only consistent with legacy facility distribution and did not address sustainable electrical distribution design using busways. In addition, the 30 A circuit can only provide 8.6 kW, which limited the 5 kW standard design's actual consumption to 4.3 kW; while loading design factors typically keep an enclosure with 5 kW (rated) load operating at not more than 70 % (3.5 kW) and within the allotted power budget. Providing the full design 5 kW of power capacity at the enclosure was deemed to be more conservative while remaining within the ability of most existing VA facilities to reject the heat generated.

4.2.1 Topology for Power Distribution Standards

Power distribution topologies in IT support spaces are dependent upon the:

- Classification archetype of the facility or IT support space
- Planned or in-use type of power distribution system, and
- Planned density of the IT equipment cabinets to be supported

Different topologies are used in data center archetype telecommunications spaces (CDCs, CSCs, and MSCs) than in distribution archetype telecommunications spaces (NSCs, entrance rooms, antenna entrance rooms, and TRs).

Active equipment installed in the VA telecommunications environment shall minimally be configured with dual-redundant Power Supply Units (PSU), excepting carrier equipment placed in entrance rooms and antenna entrance rooms. PSUs shall be rated for 208 V input and configured to operate in shared load mode rather than redundant mode to balance A/B power under normal operating conditions.

Power distribution topologies for IT equipment are 2N redundant at the IT equipment enclosure level. Where active equipment is not supplied with dual-redundant PSUs, it shall be provided with a micro-automatic transfer switch matching the power distribution system.

Deviations from the power distribution standards require an approved written variance from DCIE.



4.2.1.1 Topology for Power Distribution (CDC, CSC, MSC)

Topologies employed are dependent upon the type of branch power deployed to IT equipment enclosures. There are two types in use:

- In new construction and in renovations where there is sufficient vertical height, electrical track busway distribution is used
- In legacy facilities without adequate ceiling height, underfloor or cable-tray whips are used

For general purpose equipment enclosure load planning, utilize 50 % of the sum of the IT equipment power supply units on one distribution leg (either the A-side or B-side) to calculate the total power load for the set of equipment. In aggregate, this provides a sufficiently conservative maximum power requirement for equipment in the enclosure.

- Topologies employed are dependent on the designed density of IT equipment to be supported. There are two power density classifications: Standard and High as depicted in Figure 3 below.

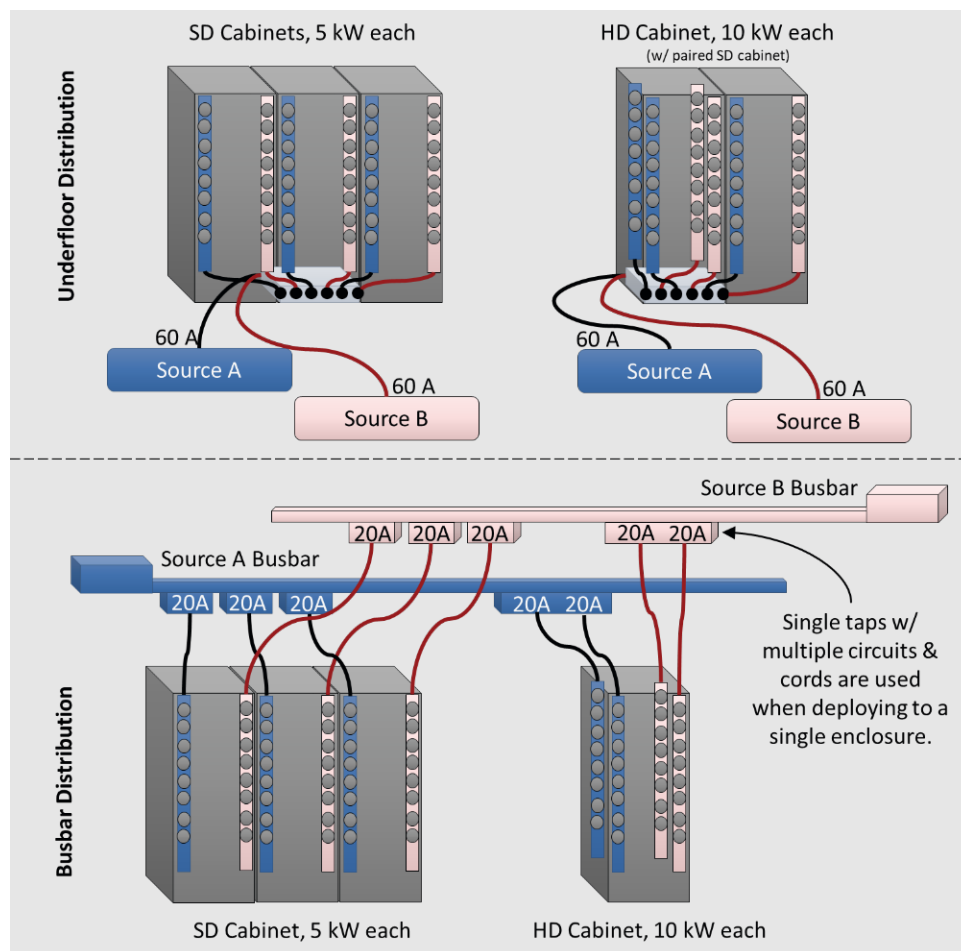

Figure 3: Power Distribution Options- Simplified Visualization (CDC, CSC, MSC)

For general IT support space purposes IT equipment cabinets will be SD, utilizing legacy underfloor/whip distribution.

Note: Insertion of HD cabinets requires specific design work by DCIE and will not be accomplished ad-hoc without approved, validated designs including CFD models showing acceptable thermal conditions of the overall design at ultimate operating load, in contingency conditions.

Power is limited to 5 kW in SD cabinets. Topology detail for this type of distribution is shown in Figure 4 and Figure 5 below. Design and install equipment load not to exceed this power and heat density without design approval and validation from DCIE.

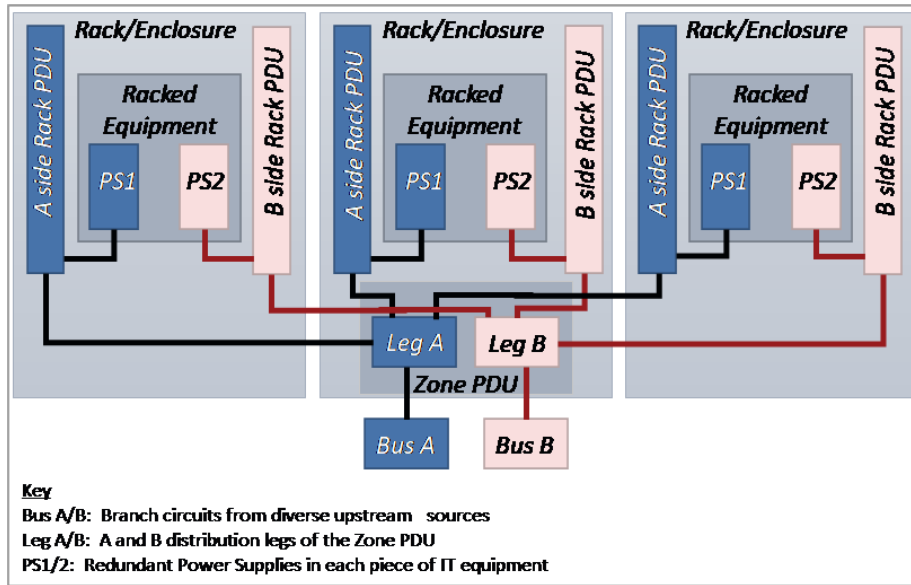

Figure 4: Standard Density Underfloor/Whip Distribution Topology (CDC, CSC, MSC) – 60 A Zone PDU

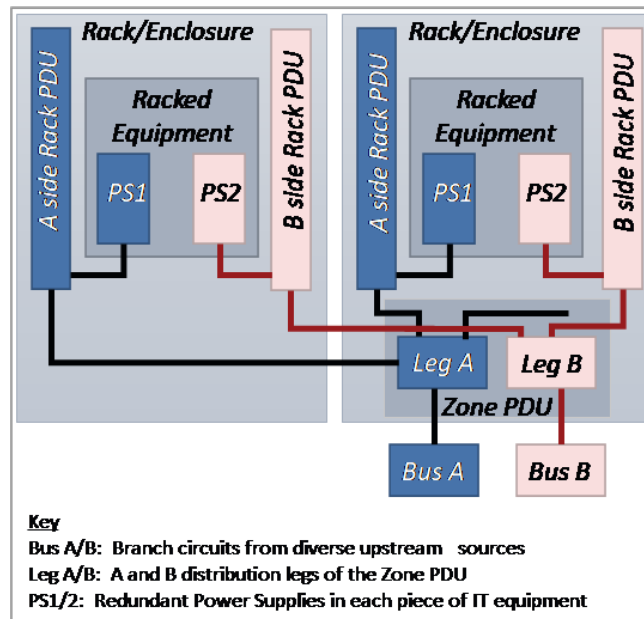

Figure 5: Standard Density Underfloor/Whip Distribution Topology (CDC, CSC, MSC) – 30 A Zone PDU



Note: Only DCIE is authorized to approve installations exceeding the SD level. HD cabinets may be possible in some facilities if heat rejection systems are properly designed and operated. HD power density is limited to 10 kW. Topology detail for this type of distribution is shown in Figure 6 and Figure 7 below:

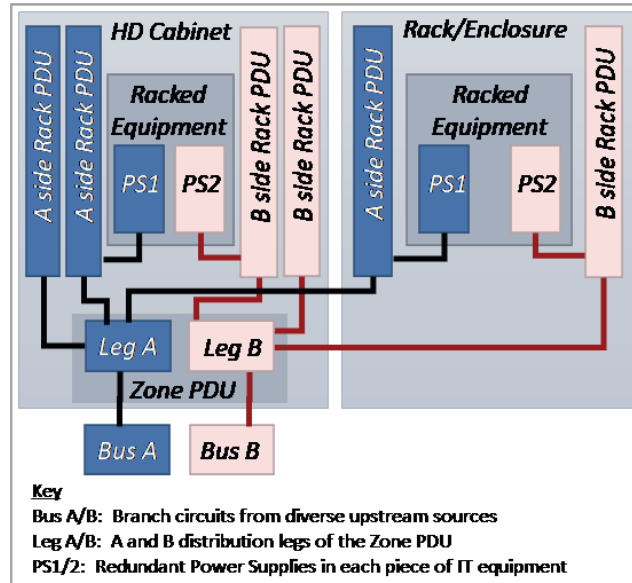

Figure 6: High Density Underfloor/Whip Distribution Topology (CDC, CSC, MSC) – 60 A Zone PDU

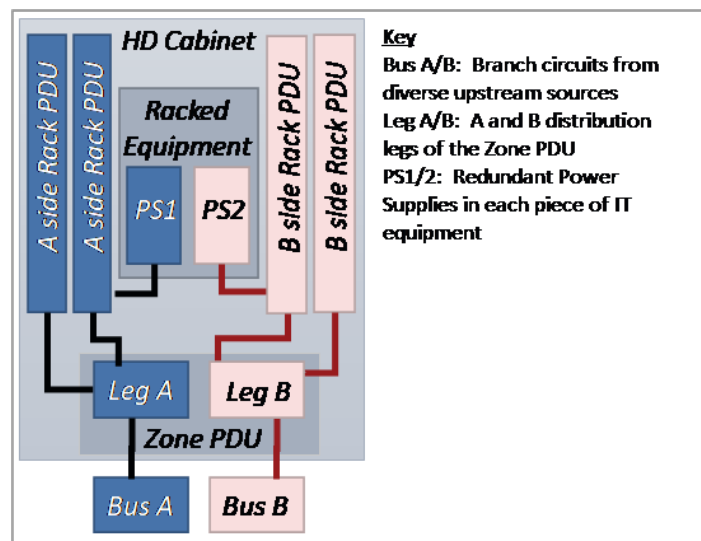

Figure 7: High Density Underfloor/Whip Distribution Topology (CDC, CSC, MSC) – 30 A Zone PDU

4.2.1.2 Topology for Power Distribution (NSC, TR, Entrance Room)

For general purpose equipment enclosure load planning in distribution spaces, utilize 75 % of the sum of the IT equipment power supply units on one distribution leg (either the A- or B-side) to calculate the total power load for the set of equipment. In aggregate, this provides a



sufficiently conservative maximum power requirement for Power-over-Ethernet (PoE) distribution switches in the enclosure.

For distribution telecommunications space purposes IT equipment enclosures will be SD, utilizing legacy whip distribution. High density enclosures are not utilized in these classifications of telecommunications spaces. Power density is limited to 5 kW per enclosure. Topology detail for this type of distribution is shown in Figure 8, Figure 9, and Figure 10 below. Only one distribution leg is required to be supported by UPS in these classification archetypes. If only a single distribution bus is powered by generator (emergency power), the UPS shall be on the same distribution leg to ensure battery recharge during generator operation.

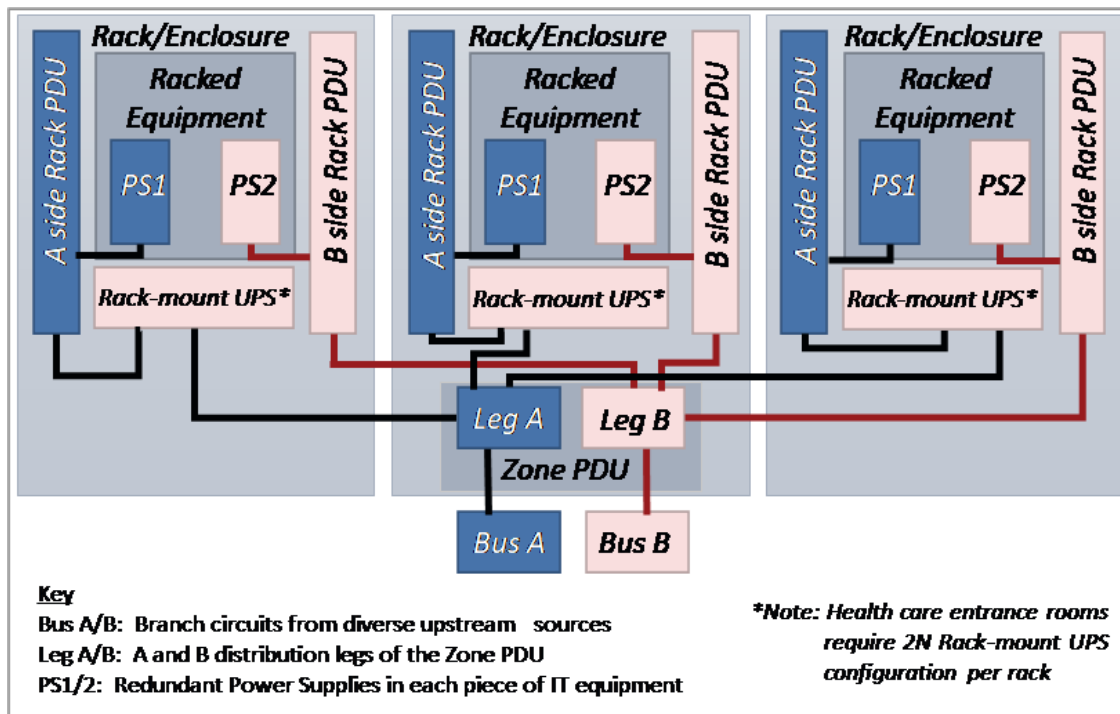

Figure 8: Whip Distribution Topology with In-Rack UPS (NSC, TR, Entrance Room) – 60 A Zone PDU



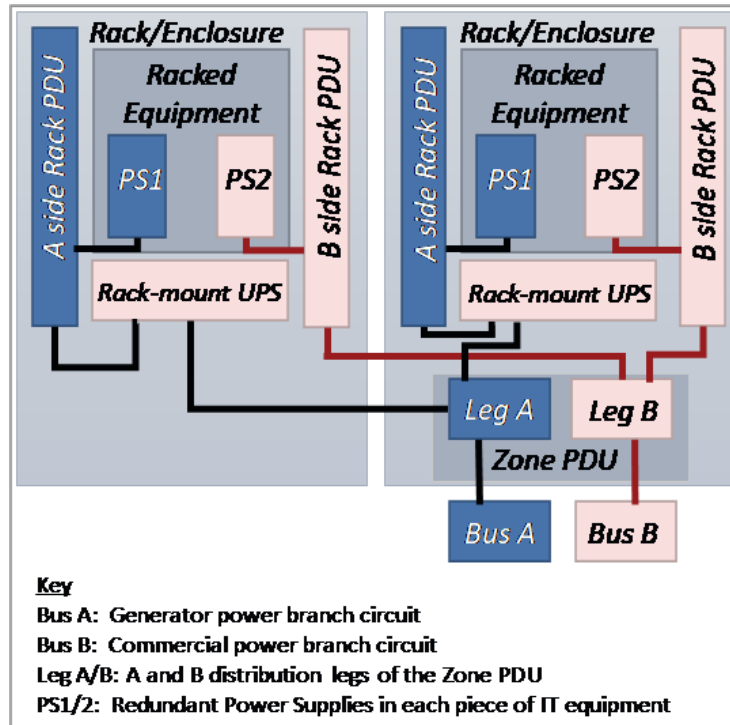

Figure 9: Whip Distribution Topology with In-Rack UPS (NSC, TR, Entrance Room) — 30 A Zone PDU

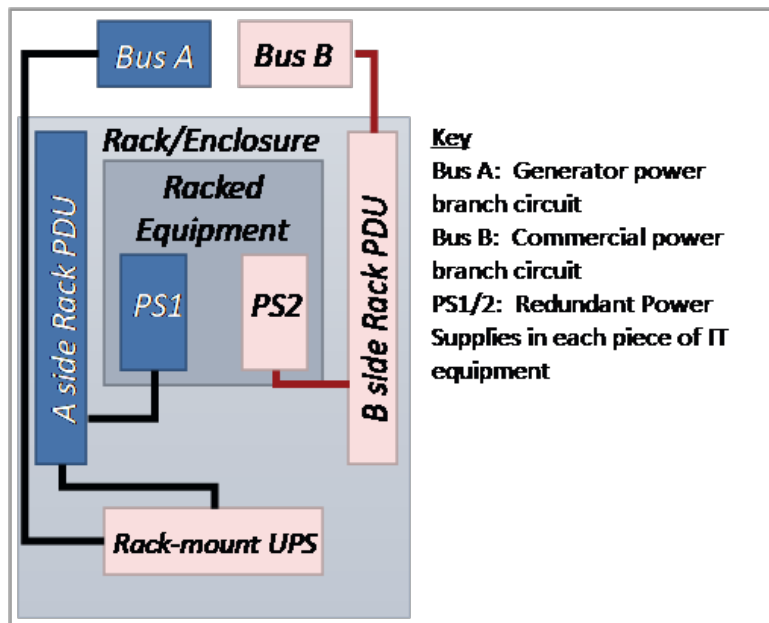

Figure 10: Single Rack Whip Distribution Topology with In-Rack UPS (NSC, TR, Entrance Room) — 20 A Circuits



4.2.2 Uninterruptible Power Supply Specifications

These specifications define the high-level technical requirements for Uninterruptible Power Supply (UPS) systems that support VA enterprise data centers and related IT spaces. This standard shall be used to quantify and qualify designs of UPS systems and the necessary physical infrastructure supporting data center facilities and spaces when those spaces are being designed, built, retrofitted, refreshed, and updated.

Facility UPS systems shall have a planned design load which covers 100 % of the ultimate IT equipment electrical load design in the data center sized to provide 10 min of backup capacity.

Table 11: Data Center Uninterruptible Power Supply Specifications

ID	Primary Attribute	Secondary Attribute	Specification
1	Technology	Inverter Preferred	UPS systems at CDCs, CSCs, and MSCs shall be inverter preferred systems, such that the power distribution path is through the inverter whether on commercial or stored power
		Double Conversion	Double conversion systems are acceptable for use as inverter preferred technologies
		Delta Conversion	Delta conversion systems are acceptable for use as inverter preferred technologies
		Line Interactive	Line interactive UPS systems (typically rack-mounted systems up to 5-kVA capacity) are specified for use in TEs
		Standby/Offline	Standby/offline UPS technologies (commonly used for desktop computer applications) are prohibited in VA data center applications
2	Design Configuration and Capacity	Serial UPS Systems	<ul style="list-style-type: none"> Serial (or cascaded) UPS systems are prohibited in VA environments Under no circumstance shall a UPS system be on a circuit supported by a separate UPS system For the purposes of this specification, any infrastructure system that uses stored battery energy as its backup is considered a UPS system (this includes server and storage IT equipment configured with external battery backup systems)
		Planned Design Load	Each “N” need on a facility UPS system shall have planned design load covering 100 % of the IT equipment loading planned for the facility



ID	Primary Attribute	Secondary Attribute	Specification
		Modularity	<ul style="list-style-type: none"> • Modular frame UPS systems with smaller, more granular UPS and battery modules are preferred over monolithic systems • Populate UPS and battery modules based on actual critical load requirements, not on ultimate design load conditions or frame capacity • Maintain internal N+1 capabilities on installed UPS and battery modules
		Upstream Sources	<ul style="list-style-type: none"> • UPS systems serving a computer room critical load shall be powered from a generator-backed source, where feasible • 2N UPS systems shall be powered from different sources to mitigate single points of failure • Ideally, 2N systems should have both systems powered from different busses with each powered from the critical branch • Where multiple busses on the critical branch do not exist, 2N UPS systems should have one system powered from the critical branch and the other system powered from the equipment branch
		Appropriate Loads	<ul style="list-style-type: none"> • Only IT data processing equipment, peripherals, and communications equipment are authorized to be powered by the data center UPS • Do not place administrative loads or mechanical equipment loads on UPS power
3	Energy Storage System	Battery Types	Valve Regulated Lead Acid (VRLA) battery systems for system designs less than 400 kVA
		Battery Sizing	Sized to maintain the UPS system full load rating for 10 min
		Maintenance Determination	<ul style="list-style-type: none"> • VRLA batteries shall only be installed in locations where preventative maintenance is readily accessible and effective • Notify DCIE during project planning



ID	Primary Attribute	Secondary Attribute	Specification
		Kinetic Energy Systems	<ul style="list-style-type: none"> • Rotary (flywheel) UPS systems require detailed, consistent maintenance that must be taken into consideration if they are to be considered for any installation • Do not install kinetic energy systems unless these maintenance requirements can be met without risk or constraints • Notify DCIE during initial project planning
4	Environmental and Monitoring System	Battery Monitoring System (BMS)	<ul style="list-style-type: none"> • Dedicated BMS equipment shall be installed on all battery strings on UPS systems with design capacities of 40 kVA and greater • BMS systems shall not be powered by the UPS batteries being monitored
		Monitoring System Technology	<ul style="list-style-type: none"> • BMS shall use a pulsed AC impedance measuring method that does not discharge the batteries during the measurement cycle • AC ripple impedance testing methods and discharge testing below cell open circuit voltages are not acceptable methods
		Battery Environment	Optimal battery life when maintained at 77 °F
		Spill Control	Required for installations using Vented Lead Acid (VLA) batteries
		Ventilation	Room monitoring and automatic ventilation is required for installations using VRLA and VLA batteries

Evaluation Factors

- UPS Technology
- Energy Storage Technology
- Battery System Environment
- BMS

Implementation Guidance

UPS systems supporting VA data center facilities shall be designed and operated in accordance with the guidance provided in this standard.

Li-ion battery systems for VA data centers are not currently authorized. They offer size, power, and weight advantages over Valve Regulated Lead Acid (VRLA) and Vented Lead Acid (VLA)



batteries, but without full consideration of the risks of their operation for this purpose in the VA [Fire Protection Design Manual \(FPDM\)](#), [HVAC Design Manual \(HVACDM\)](#), and [Electrical Design Manuals \(EDM\)](#), they may not be specified or installed.

Cascaded UPS Systems are expressly forbidden IAW 4.2.2.1.

4.2.2.1 Cascaded UPS Systems

Use of any UPS or additional battery-backed system downstream to the primary (critical bus) UPS is not an Underwriters Laboratories (UL) listed application and is prohibited by VA standards. This may jeopardize the fault clearing capability of engineered breaker coordination and introduces an additional point of failure and unnecessary load to the primary UPS thus degrading overall data center power reliability.

A downstream (cascaded) UPS is assumed to recognize the upstream (main) UPS sine wave. If the downstream UPS does not recognize the upstream UPS sine wave, the downstream UPS (when it switches on) may never synchronize back to the upstream UPS output waveform. If that should occur, the downstream UPS would stay on battery until the battery failed, then shut off.

The National Electrical Code® (NEC®) requires the ability to disconnect all electronic equipment and HVAC systems in case of fire or other emergency. In general, emergency disconnect systems are present in most VA enterprise data centers. If cascaded UPS systems are installed, the Emergency Power Off (EPO) will not de-energize the entire data center as the EPO will not be able to turn off the downstream UPS. This creates a danger to fire and rescue workers in an emergency.

4.2.2.2 Battery Monitoring

When a power outage occurs, the first system to engage and provide back-up power is the UPS, which draws from batteries until a generator can take the full load. Maintenance of these batteries and knowing how long they can be expected to continue to provide effective service is a critical link in the redundant electrical supply system. Battery Monitoring Systems (BMS) for room- and higher-level UPS equipment shall be installed and maintained for each battery string.

Rack-mounted UPS equipment requires a network interface card for connection and monitoring by the central Building Automation System (BAS) and set for alarming on certain battery conditions.

Modular UPS systems specified for room- and higher-level support functions typically have internal BMS components, and as such are exempted from the specifications below. Modular UPS systems, including battery systems, shall be connected, and monitored by the BAS.

Other (monolithic) UPS systems have separate battery strings, either cabinet- or rack-based depending on the battery technology in use. Battery strings for these UPS systems shall be connected and monitored by the BAS, and meet the following minimum requirements:



- System shall meet all current Institute of Electrical and Electronics Engineers (IEEE) recommendations for battery monitoring. System shall not be powered by the UPS batteries being monitored.
- Minimum battery parameters measured shall include cell and inter-cell impedance; system voltage; float, charge and discharge currents; and cell/ambient temperatures. Impedance measurement specification shall be to 0.1 ± 0.01 milliohms ($m\Omega$).
- System shall use a pulsed AC impedance measuring method that does not discharge the batteries during the measurement cycle. AC ripple impedance testing methods are not acceptable. Discharge testing below cell open circuit voltages is not an acceptable method.
- System shall allow individual cell replacement without disconnection and removal of the wiring harness to reduce replacement and maintenance time per cell.
- System shall use measured baseline and follow-on information for individual cells for alarm and trend analysis. Jar-level and multi-cell testing are not acceptable. Discharge data logging as well as charge and float logging shall be enabled.
- System shall be programmable to set custom test and out-of-limit alarms. System shall be integrable with third-party Building Automation Systems (BAS).
- System shall have trending, graphing, and reporting software. The software shall analyze voltage, impedance, and temperature measurements, allowing the predictability of battery performance. Software shall acquire and archive measurements and trending information for off-line presentation in report and graphical format. Software shall archive and display power outage events, their duration, decaying voltage data (if the power outage was long enough), and current out on discharge.
- System software shall be capable of being controlled remotely using Building Automation and Control Networking Protocol (BACnet), Modbus, Controller Area Network Bus (CANbus), or Fieldbus via ethernet or modem to view and modify settings and limits, acquire data and alarms, reset alarms, and perform on-line diagnosis. Software shall be capable of alarming via BAS, Simple Network Management Protocol (SNMP), email, and phone notification.
- Software shall automatically gather measurement units on a user-determined schedule for trending database construction.

Preventative maintenance services on battery monitoring systems shall be outsourced to a qualified service provider and shall include all consumable parts, remedial repairs, labor, and expenses. The service provider shall provide not less than annual maintenance services.

4.2.3 Transformers

Transformers supporting power distribution for critical loads in Rating 3 facilities (CDCs, CSCs, and some MSCs) shall be minimum K-13 rated for harmonics reduction. This includes transformers located downstream of UPS equipment supporting all critical load distribution panels, including in PDUs. No harmonics reduction is required for transformers supporting Rating 2 MSCs, NSCs, and other IT support spaces.



4.2.4 Branch Power Circuit to Rack/Cabinet

This section describes the power circuit characteristics from branch distribution panel equipment to the active IT equipment enclosure distribution equipment.

Table 12: Branch Power Circuit to Rack/Cabinet Standards (Underfloor/Whip Distribution)

ID	Primary Attribute	Secondary Attribute	Specification
1	Branch Circuit (underfloor/whip distribution)	Voltage	120/208 V
		Phase	3-phase WYE
		Amp	30 A or 60 A
		Neutral Conductor	One gauge larger than the phase conductors
		Receptacle	<ul style="list-style-type: none"> • L21-30R for 30 A zone PDUs (zPDU) • 5-wire cable hardwired junction enclosures (no receptacle) for 60 A zPDU • L21-20R may be used in legacy single-rack TRs to directly feed rack Power Distribution Units (rPDU)
		Whip Color	Differentiated by source bus (jacket or other marking)
		Whip Pathway (underfloor)	Rectilinear with respect to the equipment aisles with no diagonal runs
Whip Length	Following rectilinear path and no longer than 4 ft of slack		

Table 13: Branch Power Circuit to Rack/Cabinet Standards (Busway Distribution)

ID	Primary Attribute	Secondary Attribute	Specification
1	Branch Circuit (Busway Distribution)	Amperage	Size selected based on full load anticipated for all enclosures plus 30 % phase imbalance allowance
		Orientation	<ul style="list-style-type: none"> Diverse supply pathways to busway headends Headends for source A at one end of the row and headend for source B at opposite end Busways oriented and tap enclosures installed to maximize serviceability
		Busbar Headend	<ul style="list-style-type: none"> Amp metering Network monitoring (RJ-45) reporting
		Tap Circuit Amperage	<ul style="list-style-type: none"> 20 A Multiple circuits on same tap enclosure acceptable
		Tap Whip	<ul style="list-style-type: none"> Strain relief at exit from tap enclosure L21-20 connector
		Tap Whip Neutral Conductor	One gauge larger
		Tap Whip Color	Differentiated by source bus (jacket or other marking)

Evaluation Factors

- Headend metering for aggregation at the row level
- Amperage
- Neutral conductor gauge

Implementation Guidance

A test plan is required to ensure that each bus is properly represented in a rack or cabinet upstream through each entire distribution path.

4.2.5 Zone Power Distribution Units

This section describes the characteristics of the zone Power Distribution Unit (zPDU) used in underfloor/whip distribution topologies. The zPDU allows the implementation engineer to specify a standard branch circuit to support a pair of SD, 5 kW redundant and single HD, 10 kW redundant enclosure power configurations.



Zone Power Distribution Units reduce the number of branch circuits (whips) that need be installed to support power distribution to IT equipment enclosures, reducing requirements for circuit breaker spaces and facility power distribution panels. Their use also reduces electrical circuit material and installation labor. Where these are not constraints and the cost of deploying individual L21-20 circuits to each IT equipment enclosure is lower than their use, their use is not mandatory.

Table 14: Zone Power Distribution Unit Standards

ID	Primary Attribute	Secondary Attribute	Specification
1	60 A Zone zPDU	Mounting	Standard 19-in. rack mount
		Agency Approval	<ul style="list-style-type: none"> • UL Listed • UL Listed 60950 • UL Recognized Component Mark
		Form Factor	2 Rack Units (RU)
		AC Voltage Input	120/208 V WYE (3-phase)
		Current Input	60 A
		Current Output	20 A
		Full Load	<ul style="list-style-type: none"> • 43,200 W (21,600 W redundant) • 60 A (3-phase)
		Hardwired Junction Enclosures (Input)	Two 60 A 5-wire DIN copper terminal blocks, accommodating 4 American Wire Gauge (AWG) input conductors
		National Electrical Manufacturers Association (NEMA) Outlets for Vertical rPDUs (Output)	Six L21-20R
		Cord Length	10 ft
		Breaker Groups	<ul style="list-style-type: none"> • 60 A A-side and B-side (input) • 20 A secondary (branch) A-side and B-side (output)
2	30 A Zone zPDU	Mounting	Standard 19-inch rack mount
		Agency Approval	<ul style="list-style-type: none"> • UL Listed • UL Listed 60950 • UL Recognized Component Mark
		Form Factor	2 RU
		AC Voltage Input	120/208 V WYE (3-phase)
		Current Input	30 A



ID	Primary Attribute	Secondary Attribute	Specification
		Current Output	20 A
		Full Load	21,600 W (10,800 W redundant)
		Input	Two L21-30P
		Output NEMA Outlets for Vertical rPDUs	Four L21-20R
		Output NEMA Convenience Outlets	Six 5-20R
		Cord Length	10 ft
		Breaker Groups	<ul style="list-style-type: none"> • 30 A both A-side and B-side (input) • 20 A secondary (branch) A-side and B-side (output)

Evaluation Factors

- Power efficiency to reduce electricity losses for lowest overall lifecycle cost
- Number and type of receptacles provided

Implementation Guidance

One 60 A zPDU for each set of three SD racks or cabinets. Alternatively, one 30 A zPDU for each set of two SD racks or cabinets.

One 60 A zPDU for each set of one HD cabinet and one SD rack or cabinet. Alternatively, one 30 A zPDU for each HD cabinet.

Zone PDUs shall be mounted starting in RU1 at the bottom of the rack/cabinet due to excess weight to ensure stability, or immediately above the rack mounted UPS (if provided).

The correct specification for the zPDU is to feed it with two power sources. Power inputs should originate from two independent power sources. Each input will use identical specs: WYE (5-wire) configured, 208 V, 60 A, three-phase, terminating in vendor-provided junction boxes with terminal blocks for hardwiring conductors. The neutral conductor should be upsized one gauge to match the upsized neutral conductors in the PDU units. The neutral "upsizing" should ideally be continued in the power distribution system back to the UPS or transformer winding pole to increase the efficiency of the power distribution system and suppress harmonics in the system.

4.2.6 Rack Mounted Uninterruptible Power Supplies

This section describes the UPS systems that are mounted in racks located in NSCs, TRs, and entrance rooms where no facility UPS is available. The rack mounted UPS will provide 5 kW to 6 kW to the vertical PDU on the A-side distribution leg, supporting the SD, 5 kW design. Install



the rack mounted UPS between the zPDU and the rPDU on the A-side distribution, or between the 20 A branch circuit and the rPDU (in legacy single-rack TRs).

Rack mounted UPS systems are not utilized in the CDC, CSC, or MSC classification archetypes.

Table 15: Rack Mounted Uninterruptible Power Supply Standards

ID	Primary Attribute	Secondary Attribute	Specification
1	UPS (in rack/ enclosure)	Mounting	19 in. rack mount
		AC Voltage Input	208 V 3-phase
		Current Input	20 A
		Current Output	20 A
		Output Receptacle	L21-20R
		Input Plug	L21-20P
		Phase Type	Three-phase
		Connectivity	Network interface card required for connection and monitoring by the BAS and set for alarming on certain battery conditions
		Battery Capacity	Sufficient capacity to provide minimum 10 min runtime at current full loading levels
		kW Rating	5 kW to 6 kW

Evaluation Factors

- Battery Capacity
- kW Rating
- Not cascaded (no upstream UPS feeding another UPS)

Implementation Guidance

Rack mounted UPS shall be mounted starting in RU1 at the bottom of the rack due to excess weight to ensure stability.

Health care center entrance rooms have two UPS systems, one on the A-side and one on the B-side.



4.2.7 Vertical Rack Power Distribution Units

This section describes the vertical Rack PDUs (rPDU) (power strips) that will energize IT equipment in racks and cabinets.

Each SD rack or cabinet will receive two vertical rPDUs, one each for the A-side and B-side distribution legs. Each HD rack or cabinet will receive four vertical rPDUs, two each for the A-side and B-side distribution legs.

Table 16: Vertical Rack Power Distribution Unit Standards

ID	Primary Attribute	Secondary Attribute	Specification
1	rPDU (in rack/ enclosure)	Mounting	Zero RU, toolless
		Receptacle Type(s)	<ul style="list-style-type: none"> • C-19 • C-13
		Receptacle Quantity	<ul style="list-style-type: none"> • C-19 (6 Minimum) • C-13 (30 Minimum) • NEMA 5-20 (4 Maximum) – TRs and entrance rooms only
		Power Cord Plug	L21-20P
		kW Rating	5 kW to 6 kW
		Input Voltage Rating	208 V
		Phase Type	Three-phase
		Output Voltage	120/208 V
		Monitoring	Power utilization per phase. Light Emitting Diode (LED) display and SNMP v3.0 with Secure Sockets Layer (SSL) Encryption

Evaluation Factors

- Type of receptacles provided
- Voltage delivered (208 V)

Implementation Guidance

Mount A-side rPDU on the left side of the enclosure, and B-side rPDU on the right side of the enclosure, as viewed from the back of the enclosure.

Rack PDU models with a limited quantity of additional NEMA 5-20 outlets may be required in TRs and entrance rooms and are authorized in lieu of the standard computer room model. They



must still meet the salient characteristics of the standard rPDU, particularly the input type (L21-20P) and outlet type and quantity (C13/C19).

A test plan is required to ensure that each bus is properly represented in a rack or cabinet upstream through each entire distribution path.

4.2.8 IT Equipment Power Cords

This section describes the equipment power cords that energize IT equipment in racks and cabinets.

208 V IEC 60320 power cords connect the rPDUs to the power supplies in the active IT equipment. Each typical piece of active IT equipment will receive two power cords, one each for the A-side and B-side distribution legs. As viewed from the back of the enclosure, the A-side power cord will route from the A-side rPDU on the left side of the enclosure, and B-side power cord from the B-side rPDU on the right side of the enclosure.

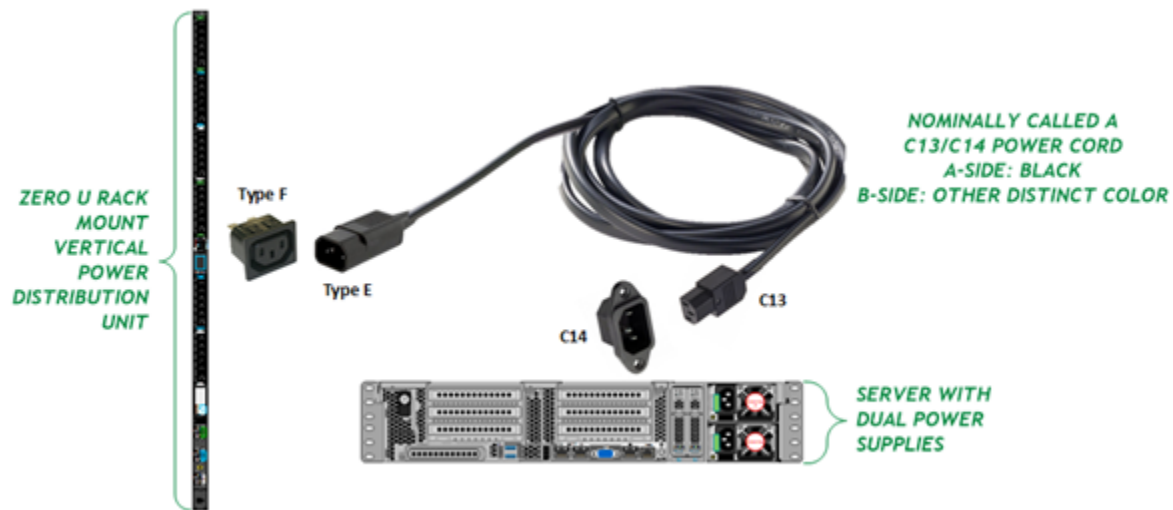

Figure 11: International Electrotechnical Commission (IEC) Standard C13/14 Cord Set

Table 17: IT Equipment Power Cord Standards

ID	Primary Attribute	Secondary Attribute	Specification
1	Equipment Power Cord	Color Code	<ul style="list-style-type: none"> • A-side: Black • B-side: A distinctly different color (white or gray preferred) • Differentiated by source bus (jacket or other marking)
		Securement	Locking configuration to match rPDU
		International Electrotechnical Commission (IEC) Standard 60320	<ul style="list-style-type: none"> • C13 at IT equipment power supply and C14 at Rack PDU (nominally "C13/C14") • C15 at IT equipment power supply and C14 at Rack PDU (nominally "C14/C15") • C19 at IT equipment power supply and C20 at Rack PDU (nominally "C19/C20")
		Voltage	UL-rated 208 V (minimum)
		Amperage	<ul style="list-style-type: none"> • 10 A (C13/14 and C14/C15) • 15/16 A (C19/C20)

Evaluation Factors:

- Connectors
- Power cord voltage
- Power cord color

Implementation Guidance:

Enterprise-class IT equipment power supplies are operable at 208 V. VA standards specify, and modern enterprise class IT equipment has, dual (A/B) redundant power supplies.

Equipment power cord connectors will be dependent upon actual equipment requirements.

Color coding of power cords is required to distinguish A and B sides for installation and troubleshooting.

Match power cord color scheme with upstream distribution color scheme where feasible. Use of colors reserved for other purposes (e.g., emergency bus distribution (red) or grounding (green) for alternate color is discouraged as these already have distinct meanings in electrical distribution.

All dual-corded IT equipment should connect to both A and B bus rPDUs for power redundancy.

Identify existing phase balancing on the rPDUs from the onboard meters. Determine which phase-grouping should receive the new equipment power cords to maintain or improve phase amperage balancing.



Install the A side (black) power cord from a rPDU on the left side of the rear of the enclosure to the corresponding IT equipment power supply.

Install the B side (white or other color) power cord from a rPDU on the right side of the rear of the enclosure to the corresponding IT equipment power supply.

Power cords should be installed into the same outlet and phase-grouping on both A and B rPDUs.

Provide IEC C13/14 (10 A) and IEC C19/20 (16 A) cord sets with all equipment requiring 16 A or less.

Except in authorized wall-mounted TEs, equipment power cords only rated for 125 V (e.g., with 5-15, L5-20, and similar plugs) shall not be ordered or installed on equipment to be installed in IT equipment enclosures without an approved variance from DCIE. Standard power distribution equipment does not support single-phase 120 V power distribution.

4.2.9 Bonding and Grounding

4.2.9.1 Bonding Practices in Telecommunications Spaces

All telecommunications spaces are to be bonded according to ANSI/TIA-607-D *Generic Telecommunications Bonding and Grounding (Earthing) for Customer Premises*, local codes, the [VA Electrical Design Manual](#), National Electric Code, and National Electrical Safety Code. Typical VA telecommunications spaces utilize Alternating Current (AC) only. Variations to the guidance below may be necessary to accommodate Direct Current (DC) installations.

Grounding through the equipment power cord(s) does not meet the intent of ANSI/TIA-607-D. The guidance below is intended to ensure that the information technology equipment be provided a dedicated and specific ground path over and above the required AC power cord ground path. While the equipment typically has a power cord that contains a grounding/bonding wire, the integrity of this path to ground cannot be easily verified. Rather than relying on the power cord(s) grounding/bonding wire, equipment should be grounded in a verifiable dedicated manner as described in this overview.

Many types of equipment do not require individual bonding conductors and as such do not have an attachment point for bonding conductors. Equipment that does not have attachment points for bonding conductors may be bonded either through the equipment rail or the power cord. Refer to the manufacturer's documentation for guidelines.

LAN elements, such as switches and routers, have bonding to chassis requirements. These requirements should not be ignored.

Rack busbars are specified below to facilitate bonding for LAN equipment. Metallic pathways under 3 ft in length (e.g., wall and floor sleeves, J-hooks) are not required to be bonded.

All wall mounted and floor mounted racks, cabinets, and pathways exceeding 3 ft in length must be bonded to the busbar within the same telecommunications space.



Other equipment, such as ventilation systems and desktop equipment outside of the equipment room, are out-of-scope for this document but must be addressed per the manufacturer's requirements.

All exterior-mounted PoE or LAN-attached equipment, such as IP cameras, must be bonded to the telecommunications bonding infrastructure described below.

ESD floor coatings shall be bonded to the SBB in the same room.

4.2.9.2 Topology Overview

A Primary Bonding Busbar (PBB) (specifications below) will be located in a telecommunications entrance room and will be bonded to the Alternating Current Equipment Ground (ACEG) bus (when equipped) or the panelboard enclosure located in the electrical entrance facility via the telecommunications bonding conductor.

A Secondary Bonding Busbar (SBB) will be installed in each telecommunications space and will connect to the PBB via a Telecommunication Bonding Backbone (TBB). The SBB should be bonded to structural steel and the electrical panelboard ACEG bus when equipped within the telecommunications space.

Access flooring pedestals must be bonded per manufacturer specifications, AHJ and code requirements, and ANSI/TIA-607-D. Typically, a single PBB will be specified per building and one SBB will be specified for each telecommunications space.

Multiple SBBs are permitted to maintain optimal conductor routing.

All bonding conductors, including the TBB, will follow sizing requirements specified in ANSI/TIA-607-D.

Bonding conductors for telecommunications should not be placed in ferrous metallic conduit. If it is necessary to place bonding conductors in ferrous metallic conduit the conductors should be bonded to each end of the conduit using a grounding bushing or using a minimum sized conductor of 6 AWG at both ends of the conduit.

Busbars will be mounted with a 2 in. clearance between the rear of the busbar to the wall. The PBB and SBB will be mounted on listed insulators. Busbar location should be determined by the location of bonding conductors to maintain the shortest and straightest path. Typically, the SBB will be mounted directly in-line with the TBB.

Computer rooms will contain an SBB and, where an access floor is installed, a supplementary bonding grid is required under the raised floor to bond the pedestals.

The connection of the TBB to the SBB and connection of conductors for bonding telecommunications equipment and telecommunications pathways to the SBB will utilize exothermic welding, listed compression two-hole lugs, or listed exothermic two-hole lugs. A Telecommunications Equipment Bonding Conductor (TEBC) will connect the racks and cabinets to the PBB/SBB. The TEBC will be a minimum of 6 AWG. Metallic objects will not serve as replacements for the TEBC; a continuous TEBC is required. The TEBC will be secured at no greater than 3 ft intervals. The TEBC should be minimum of 2 in. from other cable groups.



Bonding to the TEBC will utilize permanent compression-type fittings to create a permanent connection. Where no access flooring is used, the TEBC will be routed through cable trays. Cable trays will be installed with cable tray bonding conductors.

The TEBC will be connected to the cabinets/racks, to a Rack Bonding Conductor (RBC) or to a vertical/horizontal Rack Bonding Busbar (RBB). An RBC is a bonding conductor from the rack or RBB to the TEBC. Each cabinet or equipment rack will have a suitable connection point to which the bonding conductor can be terminated. Properly sized listed two-hole compression lugs or listed terminal blocks with two internal hex screw or equivalent torque characteristics shall be used at this connection point.

Resistance will be measured where practical between bonded elements, such as a cable tray or RBB, within a telecommunications space and the nearest PBB or SBB to confirm low-resistance continuity between that object and the busbar. Testing between an SBB and PBB should be conducted where practicable. Testing between the PBB and the Grounding Electrode should be conducted where practicable. Soil resistivity testing is beyond the scope of this document. Maximum resistance measurements for telecommunications spaces are:

- 5 Ω maximum, 3 Ω recommended for TRs
- 1 Ω recommended for data centers, entrance rooms, and antenna entrance rooms

The use of building steel can be a substitute for an intrabuilding Telecommunications Bonding Backbone if and only if:

- It is electrically continuous from the grounding busbar to the grounding electrode system
- It is bonded to the building grounding electrode system
- It passes a basic two-point continuity test showing resistance no higher than 5 Ω
- The metal in question is not concrete reinforcing steel. A TBB is recommended instead of using building steel because the later must be electrically continuous and bonded to the building's grounding electrode system

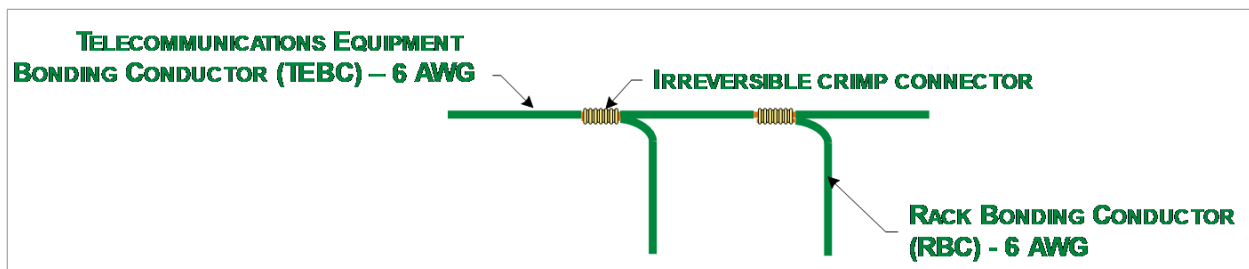

Figure 12: Typical Bonding Connection

Bends of bonding conductors terminating at the PBB or SBB will have a minimum inside bend radius of 8 inches or 90°. At other locations, bends in bonding conductors should be made with the greatest practical inside bend radius. A minimum bend radius of ten times the bonding conductor diameter is recommended. In all cases, a minimum included angle of 90° shall be used.

To limit the potential difference between telecommunications pathways or between telecommunications pathways and power pathways, all metallic telecommunications pathways

will be bonded to the RBB, PBB, or SBB. Cable tray sections will be bonded together via cable tray bonding conductors and will be bonded to the PBB or SBB.

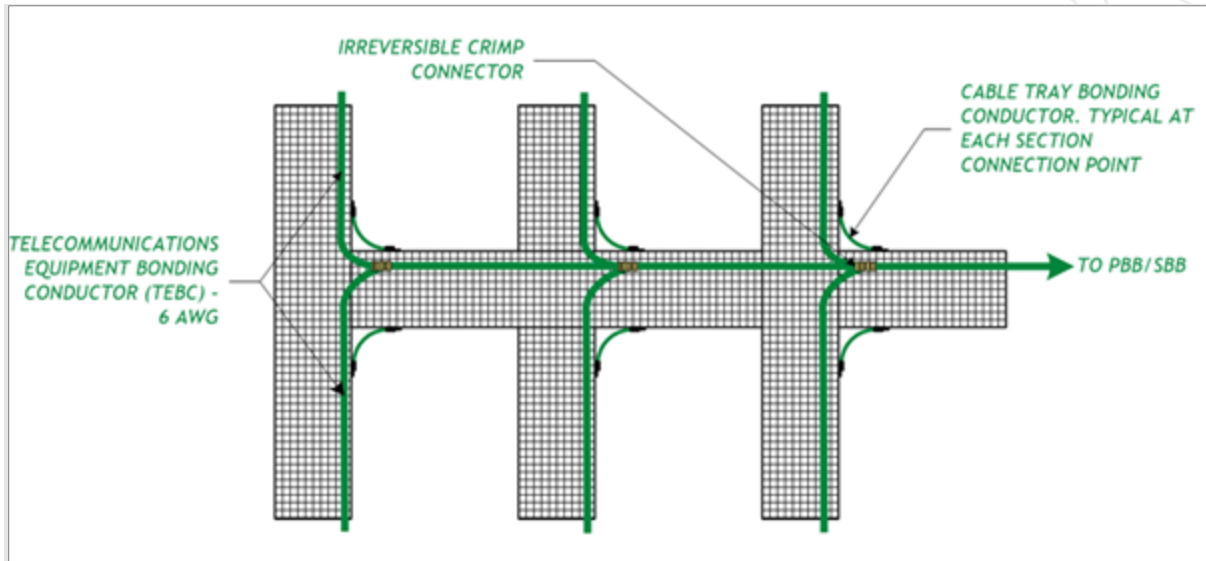

Figure 13: Typical Rack Bonding Layout

An RBB will be installed in the uppermost RU in telecommunications racks where LAN elements will be mounted. This document does not specify RBBs to be installed in server cabinets. The connection of the RBB or the TEBC to the rack will utilize exothermic welding, listed compression two-hole lugs, or listed exothermic two-hole lugs. The unit bonding conductor should be connected to the RBB using a listed compression connector and to the grounding post of the telecommunications equipment if provided. The right side in the graphic below is the preferred style and mounting approach of the RBB. The left side in the graphic below will be used in server cabinets.

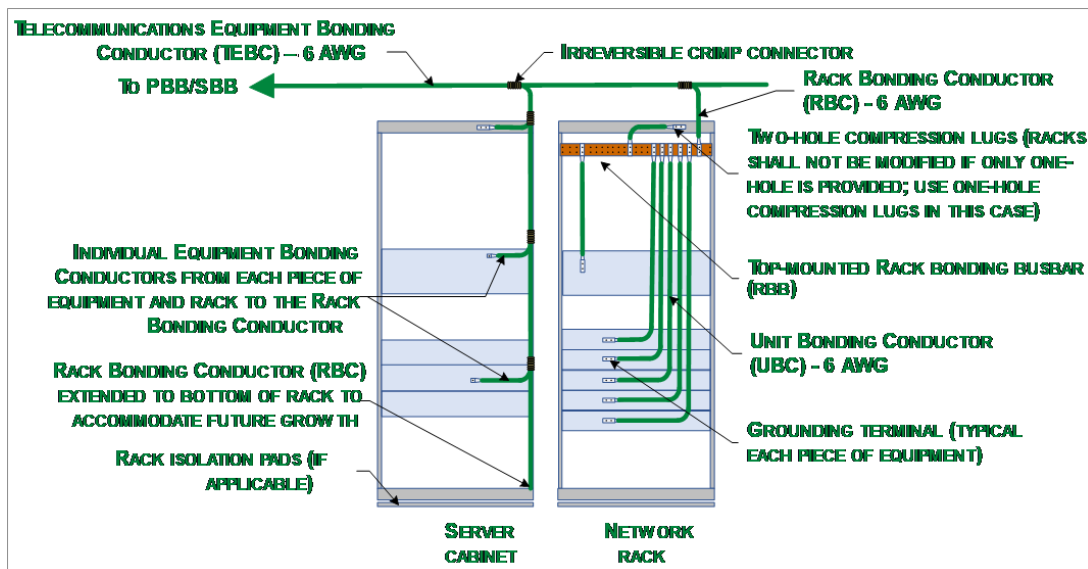

Figure 14: Typical Bonding Requirements for IT Equipment Enclosures



All racked equipment, such as LAN switching equipment, must be bonded if directed to do so by manufacturer's requirements. Never defeat the chassis bonding conductor or operate the equipment in the absence of a suitably installed bonding conductor. The ground wire from the electrical circuit energizing the device is not a replacement for chassis bonding. Racked LAN switches and other appliances requiring bonding will be bonded to the RBB located in the same rack. Each device will have a dedicated Unit Bonding Conductor (UBC) terminated with listed two-hole lugs. The UBC will not be shared or used as a bonding conductor for more than one device.

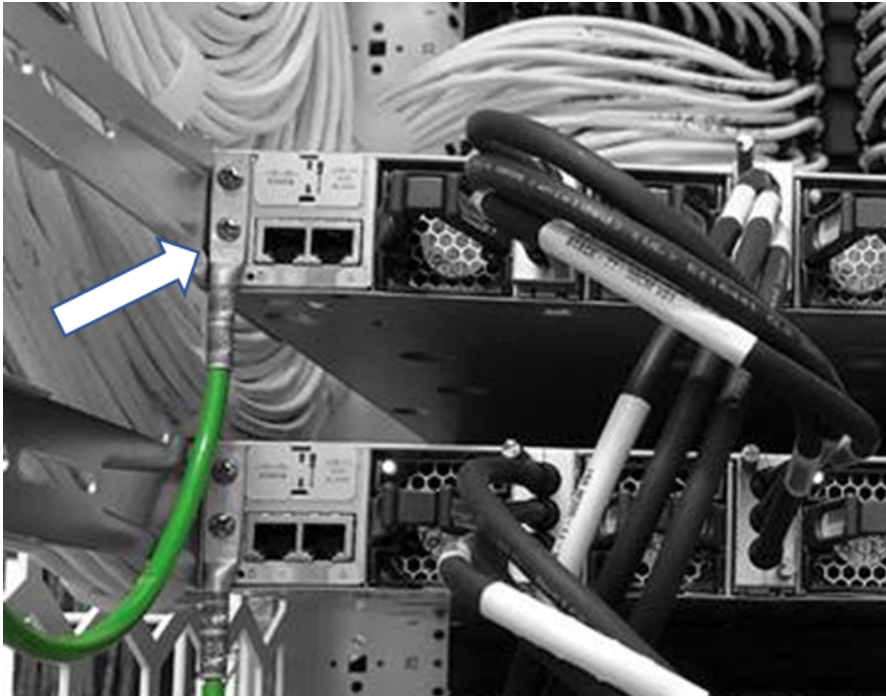

Figure 15: OEM Equipment Ground Lug Connection



Figure 16: OEM Equipment Ground Connection



Figure 17: Primary Bonding Busbar

Table 18: Busbar Standards

ID	Primary Attribute	Secondary Attribute	Specification
1	Busbars	RBB, PBB, and SBB	<ul style="list-style-type: none"> • Provided with holes for use with correctly matched listed lugs and hardware • Copper, or copper alloys having a minimum of 95 % conductivity when annealed • As specified by the International Annealed Copper Standard (IACS) • Minimum dimensions of 0.25 in. thick x 4 in. wide and variable in length • Maximum 4.0 Ω to ground system resistance (from any point in the system, including IT equipment chassis) • Listed

Evaluation Factors

- Grounding system resistance
- All ancillary equipment, rack systems, cabinets/racks, backboards, etc. bonded to the bonding conductor
- Bonding conductor materials
- Bonding conductors installed using appropriate techniques
- Bonding connections provide low impedance path to ground (tight bolts, removal of non-conductive materials between metal-to-metal contacts)

Implementation Guidance

Connect PBBs to SBBs in other rooms as required.

Provide, inspect, and maintain in accordance with the [VA Electrical Design Manual](#).

Remove powder-coated paint from racks, cabinets, ladder racks, etc. prior to installation to maximize the quality of grounding bonds.

Star-prong washers that bite into the metal may be used with caution that they must fully penetrate the paint for effective contact.

4.2.9.3 Building Earth Ground System

Note: The following sections are provided for reference only. Consult with [VA Electrical Design Manual](#) for design requirements.

A Building Earth Ground System (EGS) is required on all VA buildings regardless of the type, classification, or ANSI/TIA-942-B Rating of IT support spaces operating in those facilities.



Table 19: Building Earth Ground System Standards

ID	Primary Attribute	Secondary Attribute	Specification
1	Building Earth Ground System	NFPA 70 Article 250 compliant system	Required in all facilities
		Resistance Between Bonded Objects and SBB	4.0 Ω maximum

Evaluation Factors

Visual inspection of each telecom space for grounding system compliance required annually at a minimum.

Implementation Guidance

Provide, inspect, and maintain a facility EGS that meets the guidelines of NFPA 70 (National Electric Code) Article 250, Grounding and Bonding, and the [VA Electrical Design Manual](#).

The building EGS should obtain a resistance-to-earth of 5 Ω or less as measured by the four-point fall-of-potential method according to IEEE 81.

4.2.9.4 Lightning Protection System

Note: The following sections are provided for reference only. Consult with [VA Electrical Design Manual](#) for design requirements.

A facility Lightning Protection System (LPS) is required on all VA buildings containing a Rating 3 computer room and recommended for all VA buildings regardless of the IT support spaces operating in those facilities. Included for reference only.

Table 20: Lightning Protection System

ID	Primary Attribute	Secondary Attribute	Specification
1	Lightning Protection System	CDC	NFPA 780-compliant LPS required
		CSC	NFPA 780-compliant LPS required
		MSC	NFPA 780-compliant LPS required for Rating 3 MSCs
		NSCs and Other IT Support Spaces	LPS recommended

Evaluation Factors

- Facilities containing Rating 3 computer rooms have NFPA 780-compliant LPS protecting the entire facility
- LPS terminals and roof-mounted equipment properly bonded



- Down conductors properly connected to earth ground system and tested for ground resistance triennially

Implementation Guidance

Where required and in accordance with the [VA Electrical Design Manual](#), provide, inspect, and maintain a facility LPS that meets the guidelines of NFPA 780 (Standard for the Installation of Lightning Protection Systems).

4.2.10 Lighting

Lighting requirements in IT support spaces enable safe and reliable operation and maintenance of IT equipment and supporting infrastructure equipment. IT support spaces are intended to be lights-out operating environments except when access by operations and maintenance personnel.

ANSI/TIA-942-B recommends using LED lighting in IT support spaces to improve lifecycle cost. Managed Intelligent LED lighting in a data center can reduce server inlet temperatures by 2 °F to 3 °F. This can reduce cooling costs by up to 10 %.

Zoned and automated lighting systems meeting these requirements are acceptable.

Utilize energy-efficient motion sensors to activate lights in the immediate area soon after an employee enters an IT support space. All aisles and passageways shall be illuminated to allow for proper identification of visitors by security equipment and to allow for effective operation and maintenance of systems in the space.

Utilize a three-level lighting protocol in IT support spaces depending on human occupancy:

- Level 1: IT support space unoccupied - lighting should be sufficient to allow effective use of video surveillance equipment. Level 1 shall be provided in all IT support spaces.
- Level 2: Initial entry into the IT support space - motion sensors should be used to activate lights in the immediate area of entry and be programmed to illuminate aisles and passageways. Sufficient lighting should be provided to allow safe passage through the space and to permit identification via security cameras. Level 2 shall be provided in all IT support spaces.
- Level 3: Occupied space - when the IT support space is occupied for purposes of maintenance or interaction with equipment, lighting shall be 500 lux in the horizontal plane and 200 lux in the vertical plane, measured 3 ft above the finished floor in the middle of all aisles between cabinets. In IT support spaces larger than 2,500 ft², zone lighting shall provide Level 3 in the immediate area of work and Level 2 in all other zones. Level 3 is a requirement in all IT support spaces except for entrance rooms and TRs.

Lighting plan in IT support spaces should match the IT equipment layout. Attempt to place light fixtures in both cold and hot aisles so that technicians have sufficient illumination to work by. Lighting fixtures should be located above aisles between cabinets rather than directly above cabinets or overhead cable pathway systems.



Emergency lighting and signs shall be properly placed per Code and AHJ requirements such that an absence of primary lighting will not hamper emergency exit.

4.2.11 Metering

Metering is used to collect energy consumption data that can be used to track long-term trends, benchmark progress and performance, perform diagnostics, and alert data center operators to impending or ongoing system failures. The level of metering described is necessary for VA to:

- Baseline utility consumption
- Determine priorities for utility intensity reduction
- Measure the effectiveness of energy efficiency initiatives, and
- Show the use of power in telecommunications over time.

4.2.11.1 Metered Energy Consumption Data

All VA data center facilities shall install and operate an Automated Energy Metering system to meet the metered energy consumption data collection requirements of the metering and monitoring standards. This system may combine elements of Building Automation Systems (BAS), Data Center Infrastructure Management (DCIM) systems, Data Center Operations Systems, and others as needed to achieve the required outcomes.

All VA data center facilities shall report the following energy consumption data within the period specified:

Table 21: Metered Energy Consumption Data

Data	Units	Measured Location(s)	Period
Facility Total Electrical Consumption (FEC)	Kilowatt-hours (kWh)	Main building step-down transformer(s) and Generator plant	Monthly
Total Data Center Energy Consumption (TEC)	Kilowatt-hours (kWh)	Utility feed(s): Output to data center or Automatic Transfer Switch (ATS): Output to data center or Trunk circuit(s): Output to data center	Monthly
Total Data Center Physical Infrastructure Energy Consumption (TPIEC)	Kilowatt-hours (kWh)	Branch circuit(s) supporting physical infrastructure equipment: Output or Physical infrastructure equipment: Input	Monthly
Total IT Equipment Energy Consumption (TITEC)	Kilowatt-hours (kWh)	Rack-mounted PDU: Output or Power consumption data reported by IT system firmware: Input or Branch Circuit Monitoring (BCM) of circuit(s) supporting IT equipment: Output	Monthly



Data	Units	Measured Location(s)	Period
Total UPS Load Energy Consumption (TUPSC)	Kilowatt-hours (kWh)	UPS System(s): Output	Monthly
Total Renewable Energy Usage by Data Center (RENEW)	Kilowatt-hours (kWh)	Utility billing detail and/or Facility Engineering staff	Monthly

4.2.11.1.1 Facility Total Electrical Consumption

Facility Total Electrical Consumption (FEC) energy from the local utility is metered by the local utility provider. This portion of the metric can be obtained from the utility electrical bill or can be calculated if local resources have capabilities to read the electrical meter(s) directly.

Generator energy may be estimated by the number of hours that the generator plant(s) run times the power capacity of those generators. The time that the generators run includes building (live) load tests where the building (or some portion thereof) is supported by the generator plant but does not include offline generator tests and maintenance.

4.2.11.1.2 Total Data Center Energy Consumption

Total Data Center Energy Consumption (TEC) is the sum of Total Data Center Physical Infrastructure Energy Consumption (TPIEC) and Total IT Equipment Energy Consumption (TITEC).

4.2.11.1.3 Total Data Center Physical Infrastructure Energy Consumption

Total Data Center Physical Infrastructure Energy Consumption (TPIEC) includes the amount of energy needed to operate power supply/distribution equipment (transformers, switchgear, meters, UPS systems and PDUs, wiring to the IT devices), heating/cooling equipment (chillers, pumps, cooling towers, CRAC units), lighting in the data center, physical security systems in the datacenter (access control, intrusion detection, surveillance), fire protection and similar systems, and system electrical losses (through transmission, conversion, etc.).

VA facilities generally have shared/integrated physical plants (mechanical and electrical rooms) that provide support to both data center and non-data center (administrative, patient care, etc.) spaces. Separate metering of the portion(s) of physical plants that solely provide support to the data center should not be expected to be available because of the mixed use and legacy nature of VA facilities. There are no simple, standardized methods of obtaining this information in the shared/integrated physical infrastructure environments typical in VA facilities.

VA uses a measure/estimate methodology to obtain this information. Estimate the fraction of the load of the device supporting the data center and multiply this fraction by the monthly energy usage of the device. This fraction is an engineering estimate of what percentage of the device’s load is used to support the data center (as opposed to supporting non-data center loads). For example, based on how much chilled water flow goes to administrative office spaces versus to the datacenter (perhaps based on water pipe size), the site estimates that 65 % of the



chilled water goes to the data center. The total energy consumed by the chillers is measured at 1,460 kWh. The energy consumed to support the data center for that chiller for the month is $1,460 \text{ kWh} * 0.65 = 949 \text{ kWh}$.

Individual sites are responsible for documenting the assumptions that they use to calculate and summate physical infrastructure electrical consumption. There are no standard templates for collecting, aggregating, or estimating this information because of the unique configuration of physical infrastructure systems at each VA facility. Consult with local and enterprise facility and engineering staff as necessary and document the assumptions and process that will be used at the facility.

4.2.11.1.4 Total IT Equipment Energy Consumption

There are multiple ways to obtain Total IT Equipment Energy Consumption (TITEC) data, depending on the equipment that is installed in the data center. Use the most accurate method (methods are described from most to least accurate) to gather the metric information.

- If power distribution equipment (PDUs) in the data center have branch level metering, or if rPDU in the racks have rack-level power monitoring, whether this is connected to a facility Building Automation System (BAS)/Energy Management Control System (EMCS) (BAS/EMCS) or not, collect actual energy use data at the level closest to the IT equipment. Use of a BAS/EMCS to automatically collect and calculate this information provides the most accurate measurement.
- If PDUs in the facility have the capability to record kWh that they supply (and most modern units do), perform a manual (or automated, if BAS/EMCS capabilities are available) recording of the kWh reading on the PDU at a specified time for each reporting period (e.g., calendar month). For example, collect kWh numbers for all PDUs supporting the data center at 9 a.m. on the first calendar day of the month, and summate the change in kWh numbers from the previous period reading.
- Data centers generally have dedicated UPS systems to ensure IT equipment power is continuously available. At a specified time for each reporting period (e.g., calendar month), collect kWh numbers for all UPS systems supporting the data center and summate the change in kWh numbers from the previous period reading.
- For non-dedicated data centers and facilities where UPS systems also support non-data center administrative functions, follow the guidance for UPS kWh reporting above, and use a documented, realistic engineering estimate of the percentage of the UPS system power that is supplied to the data center IT equipment. This engineering estimate could involve counting the approximate number of amp-hours used by IT equipment in the data center and the approximate number of amp-hours that are used in a UPS-backed administrative space, and determining the ratio (3:1, or 75 %, for example). Use this estimated ratio (75 %, in our example) times the change in kWh numbers from the previous period reading to report the metric.



Where the data center does not have any of the previous metering equipment to assist in developing the metric:

- Provide a realistic engineering estimate of IT equipment power use by another method.
- Consult with local and enterprise facility and engineering staff as necessary and document the assumptions and process that will be used at the facility.

An example of how to estimate a monthly total IT electrical consumption is to use a clamp-on electrical meter on the input power cords to a dedicated electrical distribution circuit panel, determine the amperage being provided during an assumed representative time period, multiply the amperage by the panel voltage, divide by 1.73 for three-phase distribution, and convert from power basis to energy basis by multiplying by 730 (average hours per month). Other methods may be more appropriate given the equipment in and configuration of a particular data center facility.

4.2.11.1.5 Total Uninterruptible Power Supply Load Energy Consumption

Data centers generally have dedicated UPS systems to ensure IT equipment power is continuously available. At a specified time for each reporting period (e.g., calendar month), collect Total UPS Load Energy Consumption (TUPSC) kWh numbers for all UPS systems and summate the change in kWh numbers from the previous period reading. For example, last month's kWh reading on UPS 1 was 220,000 and this month's reading is 235,000. Last month's kWh reading on UPS 2 was 350,000 and this month's reading is 375,000. The Total UPS Load Energy Consumption (TUPSC) for the month is $(235,000 - 220,000) + (375,000 - 350,000) = 40,000$ kWh.

Where UPS information is not available as kWh on the UPS, consult with local and enterprise facility and engineering staff as necessary and document the assumptions and process that will be used at the facility.

4.2.11.1.6 Total Renewable Energy Usage by Data Center

Total Renewable Energy Usage by Data Center (RENEW) is the ratio of consumed energy to be produced by renewable sources and the total electrical consumption. For example, Facility X's total electrical consumption provided by electric companies for August is 4,500,000 kWh. Facility X also pays for 250,000 kWh of electricity each month to be provided from wind farms. Facility X will report 250,000 kWh (5.56 %) renewable energy usage for August.



4.2.11.2 Rating 3 Power Metering Aggregation System

A data center level power metering aggregation system is a requirement for data center facilities intended to be Rating 3 (CDCs, CSCs, and some MSCs) to collect Energy Consumption Performance Metrics. All VA data center facilities shall report the following data within the period specified:

Table 22: Energy Consumption Performance Metrics

Performance Metrics	Units	Performance Goal	Period
Power Usage Effectiveness (PUE)	N/A	<ul style="list-style-type: none"> New data centers < 1.4 with a goal of 1.2 Existing data centers < 1.5 	Monthly
Site Infrastructure Energy Efficiency Rating (SIEER)	N/A	N/A	Monthly

Evaluation Factors

- Data collection capabilities and intervals
- Data reporting capabilities and intervals
- Site-specific collection processes and engineering assumptions documented
- Performance metrics meet performance goals

Implementation Guidance

To meet aggregation system requirements for CDC, CSC, and some MSC data center facilities intended to be Rating 3, connect the data center aggregation system to enterprise DCIM system to enable Automated Energy Metering. Options for power consumption metering capability at the vertical rPDU (or PDU/BCP/RPP) level to satisfy this requirement include:

- Operate Branch Circuit Power Monitoring (BCPM) on all PDUs/BCPs/RPPs in the data center, with a single aggregation system.
- Operate single-vendor rPDU and aggregation system throughout the data center.
- Operate a single-vendor aggregation system. All rPDU must be compatible with the aggregation system. Replace noncompatible rPDU as necessary.

4.2.11.2.1 Power Usage Effectiveness

Power Usage Effectiveness (PUE) is a dimensionless metric which describes how efficiently a data center is designed and operated to conserve power. PUE is defined as the ratio: (Total Data Center Energy Consumption)/(Total IT Equipment Energy Consumption) or (TEC/TITEC)

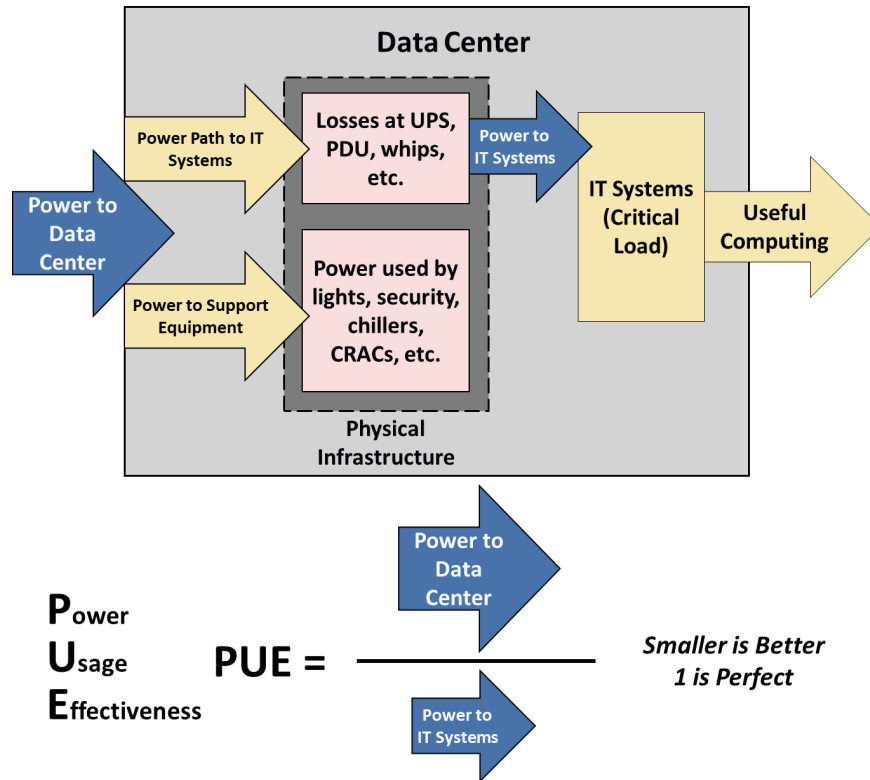

Figure 18: Power Usage Effectiveness

4.2.11.2.2 Site Infrastructure Energy Efficiency Rating

Site Infrastructure Energy Efficiency Rating (SIEER) is a dimensionless metric which describes how efficiently a data center is designed and operated to conserve power. SIEER is defined as the ratio: (Total Data Center Energy Consumption)/(Total UPS Load Energy Consumption) or (TEC/TUPSC).

SIEER measures facility and data center efficiency differently than PUE, requires significantly less metering and monitoring equipment investment, allows VA flexibility in determining what is measured in shared-use (data center and administrative or hospital) facilities, and provides information that shows efficiency improvements over time between the data center and its host facility.

SIEER is defined as the total power coming into the facility divided by the total power being supported by the UPS system (technical power load, including the power necessary to operate the UPS and downstream power distribution equipment). While SIEER and PUE are similar efficiency metrics, they are not directly comparable.

4.3 Mechanical and Environmental Conditioning Standards and Monitoring

4.3.1 Introduction

This standard provides operational guidance for environmental condition requirements in telecommunications spaces. While design requirements for systems supporting these spaces are primarily the purview of the [HVAC Design Manual](#), due to the unique nature of telecommunications spaces, designers must ensure that the designed systems will be able to meet the operational requirements described in the ISTS. Excepting air supplied for positive pressurization, telecommunications spaces are generally designed and operated as individual closed systems, therefore the design considerations differ from those of other space classifications.

The primary consideration for the provision of heat rejection systems in VA telecommunications spaces is energy efficiency. In all operating conditions, the design and operation of mechanical and environmental conditioning equipment shall consume the lowest amount of energy feasible. Optimize equipment teaming, operating sequences and controls, and the operating environmental conditions for IT equipment based on this objective.

Where guidance between the ISTS and the [HVAC Design Manual](#) differ, use the guidance in the more restrictive document for design decisions.

4.3.2 Environmental Operating Envelope Conditions

These specifications define the environmental operating envelope conditions and provide design and operations guidance for how to achieve and maintain those conditions in enterprise data centers. This Standard shall be used to specify and design computer room spaces and the environmental control systems and equipment to be operated therein.

VA data center environmental requirements are classified as Environmental Class A1 per American Society of Heating and Air-Conditioning Engineers (ASHRAE) Technical Committee TC9.9 thermal guidelines for data processing environments, requiring “tightly controlled environmental parameters (dew point, temperature, and RH)” to support mission-critical operations.

IT equipment load shall not exceed the overall cooling capacity of the data center. In general, 1 W of power consumed requires 1 W of cooling.

Excess demand requires re-engineering or self-contained high-density cooling solutions.

VA data center facilities shall maintain an average rack-face inlet temperature range of 72 °F to 80.6 °F. The average rack-face inlet temperature will be determined as the average of a standard three-sensor temperature measurement at the bottom, mid, and top height levels as measured 2 in. from the IT equipment inlets. For implementations that do not yet have the standard three-sensor installation, temperature shall be measured at 48 in. above the floor at 2 in. from the IT equipment inlets. Data center temperature and humidity conditions shall be



measured at the air intake to the IT equipment as described, rather than measuring the ambient or average condition(s) throughout the data center.

Cooling equipment set points will vary depending on equipment, set point thermocouple location, equipment location with respect to the IT equipment, and other factors. Establish and modulate the cooling equipment setpoint(s) to achieve the 72 °F to 80.6 °F equipment inlet temperature range while staying within the other (humidity, dew point) specifications. IT equipment exhaust temperatures shall not be used for determination of cooling equipment set points.

The design operating condition for cooling equipment in the data center environment is a 20 °F ΔT between supply and return airflows (e.g., across the heat transfer system of the cooling equipment). This industry standard temperature differential allows the rejection of 1 kW of heat using approximately 160 CFM of airflow. Design cooling systems to operate at a minimum of 20 °F ΔT in order to minimize energy usage by equipment fans.

VA computing facilities shall utilize engineered verified layout designs to optimize energy usage in the environmental control systems supporting the facilities. Proposed deviation from standard layout design requires verification and validation by DCIE and CFD analysis.

In general, HD racks shall be distributed across the entire data center floor to keep cooling systems from becoming ineffective.

Alternatively, dedicated HD areas may be employed with cold aisle containment to provide additional capability to power and cool to an average value below the peak enclosure value for HD equipment. Typically, this includes shortening the airflow path between the cooling system and the rack.

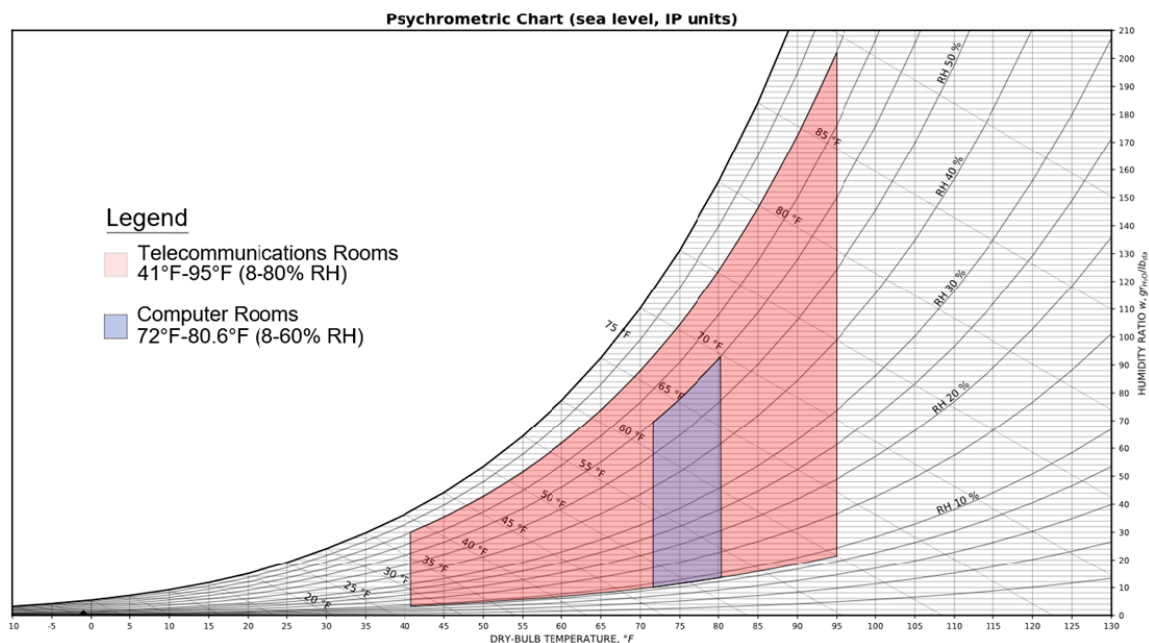

Figure 19: VA-Modified ASHRAE Environmental Classes for Data Center Applications



4.3.3 Data Center Facility Environment Conditioning Standards

Table 23: Data Center Facility Environment Conditioning Standards

ID	Primary Attribute	Secondary Attribute	Specification
1	Environmental Envelope	Temperature (at IT equipment inlet)	72 °F to 80.6 °F dry bulb (VA modified recommendation is intentionally more stringent than ASHRAE minimum of 64 °F for additional energy savings)
		Humidity (at IT equipment inlet)	8 % RH to 60 % RH (in healthcare facilities, the more restrictive requirements of the HVAC Design Manual must be met)
		Dew Point (at IT equipment inlet)	≤ 59 °F
		Rate of Temperature Change	≤ 9 °F per hour
		Room Height (vertical dimension)	16 ft height (12 ft legacy) from finished floor to floor above, with larger heights preferable
		Monitoring	Varies by classification (see Amendments and Exceptions Tables below)
2	Environmental Control Equipment	Primary Air Conditioning Type	CRAC
		Airflow Plenum	Non-ducted architectural plenums (underfloor, above ceiling, etc.) should not be used in new construction or renovation of existing spaces
		Static Pressure (raised floor)	0.15 in. of Water Column (WC), Design distribution shall be not less than 5 kW (1.422 ton) of cooling per each 25 % perforated tile
		Airflow Tile (raised floor)	Placement per CFD analysis; typically: <ul style="list-style-type: none"> • 25 % open for SD racks • 50 % open for HD racks • Air Removal Units (ARU)/active tiles for unique hot spots
		Airflow Control Equipment (raised floor)	Fill in all floor penetrations to eliminate leakage to minimize cooling plenum static pressure loss



ID	Primary Attribute	Secondary Attribute	Specification
		High-Capacity Grate Tiles (raised floor)	May be used in the floor near HD areas (over 5 kW per rack) to eliminate hot-spots and air shortages
		Overhead Supply Air Ducts	<ul style="list-style-type: none"> • Vents directly placed over cold aisle • Placed as closely as possible to equipment intake • No lateral diffusing vents
		Ducted Systems Hot Air Return Vents	When used, placed as closely as possible to equipment exhausts or directly connected via flexible duct connections
		Blanking Panels	Required in every RU where no equipment resides on the front (cold aisle) of each cabinet
		Computational Fluid Dynamics (CFD)	Required for all new or significantly modified computer rooms (except NSCs)
		Containment Systems	<ul style="list-style-type: none"> • Must be considered for all new or significantly modified data centers • Required where close-coupled air conditioning is employed
		Rules-based Borrowed Cooling (existing data centers)	<ul style="list-style-type: none"> • Utilized for high-density deployment to borrow adjacent underutilized cooling capacity • Racks separated to prevent exceeding peak enclosure power and cooling values
		Close-Coupled Air Conditioning Systems	Used only with a containment system and when shown to be effective in CFD modeling

Evaluation Factors

- Temperature and humidity controlled within designated parameters
- Temperature and humidity measured at appropriate locations
- Bypass and recirculation air measures implemented
- CFD modeling used for data center design

Implementation Guidance

Relative humidity of the data center environment must not be less than 8 % to preclude static buildup and must not exceed 60 % to preclude water condensation, hardware corrosion, and early system and component failure.



Identify an environmental control window that is compatible with all the different thermal specifications, types of equipment, and equipment vintages in the data center for optimal energy saving.

CFD modeling shall be used iteratively in data center design to specify equipment requirements and location, duct sizing and location, control system designs, and operating guidance to minimize heat rejection system energy utilization in CDC, CSC, and MSC data center classifications at all operating states (from partially-loaded to ultimate design load).

Minimization of energy use by this system is a primary design consideration. CFD shall not be used to show that a design can be made to work without taking minimization of energy use into account.

4.3.4 Data Center Facility Environment Conditioning Standards (Amendments and Exceptions)

Amendments and exceptions to the requirements in Section 4.3.3 are listed in tables below for each class of data center to include NSC standards which are not covered above.

Table 24: Facility Environmental Requirements (CDC Amendments and Exceptions)

ID	Primary Attribute	Secondary Attribute	Specification
1	Environmental Envelope	Alarming	Automatic alarming when parameters are exceeded is recommended where automated systems are available
		Monitoring	Monitoring integrated into BAS with automatic alarming when conditions exceed prescribed limits

Table 25: Facility Environmental Requirements (MSC Amendments and Exceptions)

ID	Primary Attribute	Secondary Attribute	Specification
1	Environmental Envelope	Monitoring	Monitored by automatic system(s) in multiple locations, with indicators allowing operators to determine the general condition of the computer room



Table 26: Facility Environmental Requirements (NSC Amendments and Exceptions)

ID	Primary Attribute	Secondary Attribute	Specification
1	Environmental Envelope	Temperature (at IT equipment inlet)	For TRs only: 41 °F to 95 °F dry bulb (in healthcare facilities, the more restrictive requirements of the HVAC Design Manual must be met)
		Humidity	For TRs only: 8 % RH to 80 % RH (in healthcare facilities, the more restrictive requirements of the HVAC Design Manual must be met)
		Dew Point	For TRs only: ≤ 82.4 °F
		Room Height (vertical dimension)	No raised floor or suspended ceiling, maximize internal room height
		Monitoring	Monitored with indicators allowing operators to determine the general condition of the computer room
2	Environmental Control Equipment	Primary Air Conditioning Type	Air Conditioner Units in any NSC with active IT server and storage components
		Humidity Control Equipment	No dedicated humidity control equipment required
		Airflow Plenum	Not applicable
		Airflow Control Equipment	Not applicable
		Computational Fluid Dynamics (CFD) Modeling	Not required
		Containment Systems	Not specified



4.3.5 Environmental Control Equipment Requirements

Note: The classification of CRAC units, for the purposes of this document, includes Chilled Water (CW) Fan Coil Units (FCU), Computer Room Air Handler (CRAH) units, split system Direct Expansion (DX) CRAC units, and similar types of dedicated floor-mounted systems.

Table 27: Environmental Control Equipment

ID	Primary Attribute	Secondary Attribute	Specification
1	Computer Room Air Conditioner (CRAC) Equipment	Type	Only downflow CRACs shall be used except where other options can be modeled as the most acceptable efficient design in a CFD model.
		Total Cooling Capacity	Not less than 10 Refrigeration Ton (RT) per unit (Note: NSCs and their subclass telecommunications spaces are covered separately)
		Placement	CRAC units employed with raised access floors should be placed perpendicular to hot aisles for effective air distribution supply to the cold aisles. Applies to all configurations that use CRACs.
		Fan Type	<ul style="list-style-type: none"> • New and replacement units shall utilize Electronically Commutated (EC) fan technology • Upgrade centrifugal fan units with EC plug fans where feasible
		Variable Speed Drive (VSD)	<ul style="list-style-type: none"> • Shall be used in all possible applications • Fan(s) should be controlled by an automated VSD system provided internally to the CRAC or as supplementary external equipment powering the fans • Older CRAC units shall be retrofitted with VSDs



ID	Primary Attribute	Secondary Attribute	Specification
		Intake Chimneys	<p>If not fully ducted return or connected to a return plenum:</p> <ul style="list-style-type: none"> • Utilize CRAC intake hoods, extended returns, or chimneys on downdraft models to draw in heated air from the highest, warmest part of the room when possible to maximize ΔT across the cooling coils. • Do not extend hoods into a void ceiling space. • Leave at least minimum 18 in between top of chimney and the ceiling to allow return air to flow naturally into the chimney without constriction. • Retrofit existing CRAC units with hoods where feasible.
		Floor Stand	Where CRAC units are used in computer spaces with a raised access floor, they shall be mounted level with the finished floor level on an adjustable, seismic-rated floor stand designed for the equipment.
		Service Clearance	Provide clear space around units as recommended by the manufacturer (typically 36 in. on the front and each side)
		Control System	<ul style="list-style-type: none"> • Install a management control system for all computer rooms with two or more CRAC units. • The control system shall operate the system(s) in the most energy-efficient manner possible maintaining planned system redundancy levels, specified IT equipment inlet conditions, and maximizing the ΔT between the CRAC supply and return.



ID	Primary Attribute	Secondary Attribute	Specification
		Local Monitoring	<p>Each CRAC shall have a local monitoring panel affixed to the unit accessing the following information:</p> <ul style="list-style-type: none"> • System automatic restart with programmable delay • Sequential load activation • Sensor calibration • Current temperature set point and location of that set point • Current supply and return temperature and humidity • Unit diagnostics (fan, valve, alarm) • Alarm log history • Runtime log • Audible and visual alarm
2	Split System Air Conditioner Equipment	Operation	Automatic operation to maintain set point temperature in the telecommunications space for outside environmental conditions between the ASHRAE Fundamentals Weather Data 99.6 % column for Heating (Winter) and 0.4 % column for Cooling (Summer)
3	Portable Air Conditioner Equipment	General Usage	Shall not be used as part of a planned cooling system in VA data centers
		Emergency Usage	May be used for supplemental emergency cooling for short durations when primary equipment is unable to support the design load (e.g., until repaired)
4	Portable Fire Suppression	Type	Use only AHJ-approved clean agent portable fire suppression devices in telecommunications spaces

Evaluation Factors

- Equipment redundancy
- CFD analysis
- Energy efficiency
- Heat rejection capacity



Implementation Guidance

CFD modeling is required for all CDC, CSC, and MSC environments. CRAC unit placement and capacity shall be confirmed at computer room ultimate design load condition in all contingency conditions.

CRAC unit selection and placement shall be selected for the most energy efficient approach satisfying computer room ultimate design load condition in all contingency solutions. CRAC unit capacity shall be holistically balanced with computer room ultimate design load, considering required equipment redundancy.

CRAC unit operation shall be designed for the most energy efficient approach at all computer room loading conditions, operating within the prescribed environmental conditions, typically using Supply Air Temperature (SAT) and fan speed controls.

Each IT equipment enclosure in a data center environment (MSC, CSC, and CDC archetypes) shall have a minimum of 5kW of cooling capacity to be available. For design purposes, model the ultimate design load for these data center spaces to require the following amounts of heat rejection:

- Standard Density server cabinet - 5 kW (3.5 kW in raised floor environment used for cooling air distribution)
- HDA network channel rack - 2.8 kW
- MDA active equipment network channel rack or cabinet - 3.5 kW
- MDA passive equipment network channel rack or cabinet - 0 kW

Environmental control in NSC environments (including TRs and entrance rooms) shall typically be accomplished using dedicated split system air conditioners. Each installed enclosure requires 5 kW of cooling capacity to be available, but in aggregate 5kW per enclosure is not required.

Design heat rejection capacity in these telecommunications spaces as follows:

- 1-rack TR = 5 kW
- 2-rack TR = 7 kW
- 3-rack TR = 8.5 kW
- 4-rack TR = 10 kW

Other designs meeting these maximum expected aggregated load levels are acceptable. Multiple smaller units will assist in avoiding equipment freeze-up in some types of equipment.

4.3.6 Airflow Control

4.3.6.1 Room Height

Legacy facilities are encouraged to maximize room height (vertical dimension) through the removal of aesthetic suspended ceilings to maximize cooling efficiency.

4.3.6.2 Air Distribution Ceiling Plenums

In new designs, ceiling void spaces (above a suspended ceiling) shall not be used as plenum spaces for air distribution (return) except when fully ducted above a suspended ceiling. Legacy



facilities may continue to use down flow CRAC units with in-room and above-ceiling return designs. When used as a plenum (without ducting), the horizontal surfaces of the plenum must be periodically cleaned (vacuumed). Taking the friability of typical suspended ceiling acoustic tiles, their location above IT equipment, and the interface of other infrastructure equipment (lighting, fire suppression, structured cabling systems, etc.) into account, the maintenance requirement is not offset by the additional risks and costs incurred.

In existing spaces, unless directly ducted to the IT equipment rack discharges, do not extend CRAC intakes through a closed suspended ceiling, as this makes the space a plenum.

A recommended best practice is to remove suspended ceiling systems in data center facilities altogether to allow additional room for exhausted hot air to rise. Because cooling equipment efficiency is directly proportional to the change in temperature, extending CRAC intake ducts to the hottest exhaust air near the ceiling presents the greatest opportunity for efficiency.

Where the ceiling void space is used as a plenum return in existing (legacy) facilities, future physical infrastructure technical refresh projects shall change the air path to eliminate this usage.

4.3.6.3 Air Distribution Floor Plenums

The goal of using air distribution floor plenums is to provide uniform tile air velocity cooling effect across all perforated tiles or grilles.

Overhead cabling must be used whenever possible to eliminate possible airflow restriction. Under-floor obstructions such as network cables and power cords are minimized to prevent obstruction of airflow and cooling supply to the racks. Any excess unused shall be reclaimed to minimize blockage of air flow. Floor vents are not placed too close to CRAC units to avoid producing negative pressure which causes room air to be drawn back under the floor.

CFD analysis is required before selecting raised-floor solutions.

4.3.6.4 Perforated Tiles and High-Capacity Grates

Perforated tiles or grates are used to introduce cold air directly into the equipment intake in the cold aisle. An appropriate number of tiles or grates are used to match the load that is calculated in the cold aisle. Improperly placed tiles increase non-functional airflow and reduce the pressure of cold air flow where it is required. Placing too few in the cold aisle will cause recirculation and too many will increase the amount of bypass. If airflow efficiency cannot be optimized, bypass is preferred over recirculation.

High-capacity grate tiles may be used in the floor near HD areas (over 5 kW per rack) to eliminate hot-spots and air shortages. These should not be automatically addressed by installing high-capacity grates without considering the complications that may be introduced:

- High-capacity grates pass three times more air than normal capacity tiles and may alter the fixed pressure that is required to feed cold air to other servers
- Additional forced air may bypass the intended target equipment and flow right past the faces to the top of the aisle providing no benefit



- Creates large airflow variations
- Dramatically alters under-floor pressure gradients, making cooling non-uniform and unpredictable
- Impacts airflow in neighboring areas. Some locations will NOT receive sufficient cooling
- Air Removal Units (ARU) or active floor tiles are used to improve targeted air flow for higher density racks

A recalculation of CFD modeling is required when high-capacity grates or active floor tiles are added or relocated.

4.3.6.5 Air Containment Devices

Where an underfloor plenum is used for cooling air distribution, all access floor penetrations shall be sealed with authorized materials such as brushed floor grommets and air dam foam sheets to maintain the rating of any fire and smoke barrier and to minimize cooling plenum static pressure loss.

4.3.6.5.1 Brushed Floor Grommets

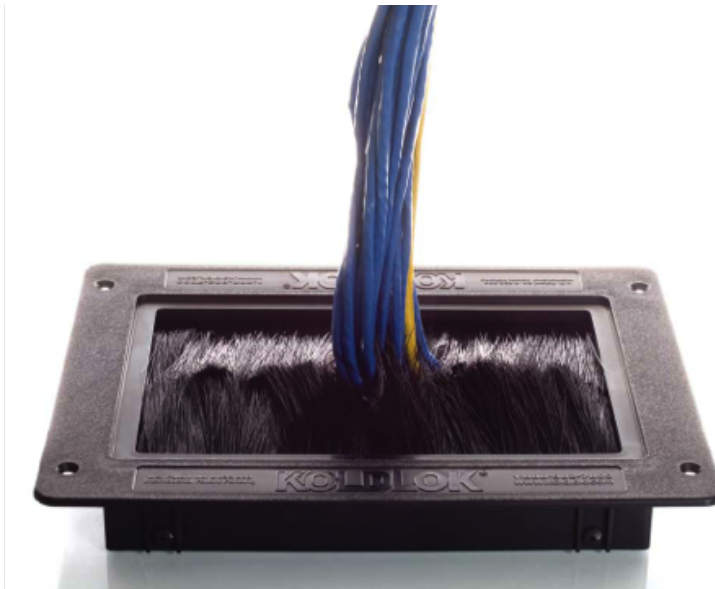

Figure 20: Brushed Floor Grommet

4.3.6.5.2 Air Dam Foam Sheets

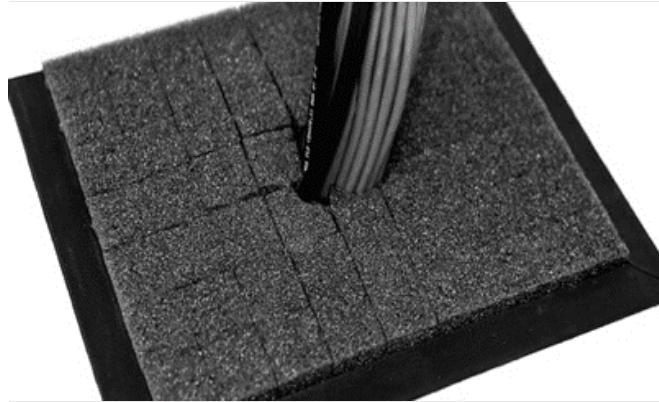

Figure 21: Air Dam Foam

4.3.6.5.3 Blocking Recirculation Paths

Recirculation air from gaps between and under racks and cabinets has been shown in CFD analysis and thermal survey measurements to be a significant contributor to cooling inefficiency in VA data centers.

Ensure that IT equipment racks and cabinets are installed flush to one another without air gaps between the racks. Use appropriate materials to fill gaps between racks to prevent recirculation of exhaust air to the cold aisle.

Install baying kits are required to keep cabinets aligned.

Install blanking materials under IT equipment racks and cabinets in the same plane as blanking panels.

4.3.6.5.4 Blanking Panels

Blanking panels reduce hot spots and recirculation of air by preventing equipment exhaust air or hot-aisle air from migrating to the conditioned air-intake stream at the front of IT equipment racks or cabinets.

All IT equipment racks and cabinets shall have blanking panels and air dams installed in all positions within the enclosure that do not contain equipment to prevent recirculation of cooling airflow.

Failure to do so causes hot exhaust air to mix with the cool supply air (see Figure 22 Example A below) and does not allow for an adequate amount of cool air to reach the intake of all the equipment present in the rack. With blanking panels installed (see Figure 22 Example B below) the hot air does not have a path back to recirculate so only cold air is provided to the equipment intake.

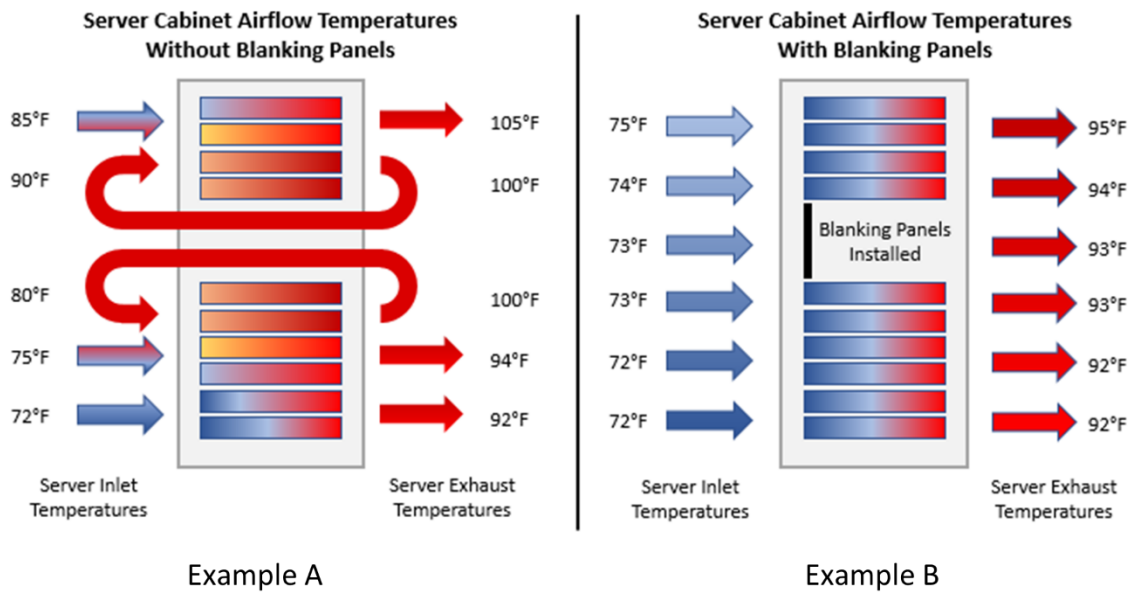

Figure 22: Blanking Panel Application

When angled patch panels are used, angled panel covers are a requirement to block airflow over and under the patch panel. Angled blanking panels can be used between angled patch panels; however, angled panel covers must be used at the top and bottom of an angled stack.

Seal other cabinet holes that traditional blanking panels and panel covers do not fit with manufacturer sealing kits.

Other air containment solutions including expanding foam pillows, fire-stop caulking, temporary metal or fiberboard cover plates, and commercial expanding foam are not acceptable for use in VA data centers; they are either temporary, are not flexible enough to allow for re-cabling, require replacement during any changes, or may present fire and safety hazards.

4.3.6.5.5 Air Distribution Containment Systems

Legacy VA data centers typically use the entire room volume as a heat sink, the least efficient and least effective manner of controlling temperatures and humidity.

Air containment systems may increase the efficiency of data center HVAC systems by separating cold supply and hot return air streams, allowing hotter and drier air to be introduced to the CRAC unit or close-coupled cooling system. The efficiency of these systems is directly proportional to the ΔT between the air streams.

Containment systems may be installed in any VA data center to improve the efficiency and/or effectiveness of the HVAC system. Containment systems are required to be installed in all VA data centers where close-coupled cooling systems are employed. Both hot and cold containment system designs are acceptable and may be appropriate for use in VA data center

facilities. Use CFD modeling to determine which design solution(s) will be most effective and cost-effective prior to implementation.

Local AHJ fire and safety standards may supersede this Standard or make containment solutions cost prohibitive.

4.3.6.5.6 Containment Equipment

Use the most cost-effective containment solution available that will satisfy the efficiency design criteria for a given implementation. Hard walls, sliding doors, and hard roofing containment which may be difficult to retrofit and cost prohibitive, while often the most effective containment, are not required. Polyvinyl chloride (PVC) strip curtain walls (vinyl sheeting) solutions, which are inexpensive and the least complicated solutions to install, are acceptable.

When containment is used, consideration must be given to fire alarm and suppression systems to ensure containment systems do not interfere.

4.3.6.5.7 Cold Containment

Cold containment solutions are intended to collect and contain cold (supply) air from cooling units (CRACs) at the inlets of the IT equipment. Design and operate cold containment solutions such that appropriate volumes of air are presented (generally a 10 % overpressure) to the cold containment zone to provide enough pressure to inhibit reintroduction of hot air into the containment but not overly pressurized to avoid inefficiencies with bypass airflow (either excess air being forced through IT equipment or leakage due to over-pressurization). Cold containment retrofits will generally require the least amount of equipment to implement.

Cold containment may be used in conjunction with heat containment solutions to achieve air stream separation goals. Partial cold containment solutions, when used with proper airflow management equipment, can provide significant efficiency returns with minimal amounts of investment. For example, the addition of end-of-row containment doors, with no other containment, may improve airflow efficiency up to 15 % in some data centers.

4.3.6.5.8 Heat Containment

Heat containment solutions are intended to direct hot (exhaust) air from IT equipment racks away from areas that it can mix with cold (supply) air entering the IT equipment rack face. Heat containment may be used in conjunction with cold containment solutions to achieve air stream separation goals.

4.3.6.5.9 Chimney Return Systems

An effective subset of heat containment, chimney VED return systems direct the exhaust from IT equipment racks vertically to a ducting system that returns the hot air stream directly to the CRAC unit intakes without mixing. This variant on heat containment requires extensive installation work, limiting its ability to be implemented in operational data centers.



Do not employ chimney systems without ducted returns unless the finished ceiling is at least 12 ft and chimney has 18 in. of clearance below the ceiling to allow for natural, unrestricted airflow.

4.3.6.6 Heating, Ventilation, and Air Conditioning Environmental Control Equipment

In general, legacy VA data centers use a pressurized subfloor air distribution plenum for cooling air distribution to IT equipment. It is not necessary for future VA data centers to use this model if other, more efficient and effective environmental control models can be used.

Alternative air conditioning types are allowable provided they increase the efficiency of the HVAC system and do not provide more cooling than the ultimate design load of the data center (for example, do not install a 5-ton CRAC unit in a NSC designed to contain one ton of IT equipment).

4.3.6.7 Computer Room Air Conditioner Units

Floor-mounted CRACs are generally used in conjunction with raised access floor distribution plenums in legacy VA data center facilities. Where used with a raised access floor, CRACs shall be supported by manufacturer-specified, seismic-rated floor stands independent of the access floor.

Utilize high-efficiency Electronically Commutated (EC) plug fans in CRAC units. Retrofit legacy CRAC units with EC plug fans for increased operational efficiency where feasible.

4.3.6.8 Split-System Air Conditioning Units

Split-system air conditioning units are air-cooled Direct Expansion (DX) or water-cooled units which are systems typically with a ductless connection between a compact heat exchanger component in the interior space and a condenser (heat rejection) component external to the controlled environment that is either wall mounted or is mounted within a suspended ceiling system. These units are only appropriate for use in small, non-critical, distributed VA data centers and other small IT-related spaces. The typical configuration of these rooms is a local server room or TR. Size these systems to match the ultimate design load of the space. Due to the non-critical nature of IT equipment operating in these facilities, redundant equipment is not required.

4.3.6.9 Portable Air Conditioning Units

Portable air conditioning units (air-cooled or water-cooled) are considered inappropriate for long-term use in VA data center spaces and shall only be used for temporary spot cooling purposes in the event a primary system is inoperative. Portable units shall not be used to increase the cooling capacity of a VA data center to increase the amount of IT equipment that can be installed.

4.3.6.10 Close-Coupled Air-Conditioners

The use of close-coupled air conditioning systems is permitted in VA data centers when the systems are specifically designed into the support model. In general, use close-coupled systems



in portions of the data center designed for HD (> 5 kW per IT equipment rack). When close-coupled systems are used, containment must be implemented in the zone(s) where the systems are installed.

Close-coupled systems shall not be used to increase the amount of cooling available within a data center unless the power being supplied to the data center is simultaneously being increased (increased design capacity in both power and cooling must match).

4.3.6.11 Fans and Supplemental Airflow Augmentation Devices

The use of fans and supplemental airflow augmentation devices in VA telecommunications spaces is prohibited without CFD analysis confirming their necessity and environmental benefit in the proposed operating environment.

Floor-mounted and portable fans shall not be used in computer rooms or TRs; provide appropriate permanent heat rejection and air circulation equipment instead. Do not use fans to evacuate heat from IT equipment enclosures (except as an integral part of TE design).

4.3.6.12 Humidity Control Equipment

Humidity control equipment shall be used in VA data center facilities to allow operators to maintain the computing environment within the allowable operating parameters and to minimize the energy required to provide a stable and efficient environment for IT equipment.

System design shall comply with ANSI/ASHRAE Standard 188 (current version) and VHA Directive 1061 for Legionella control.

Defer to the HVAC Design Manual for additional guidance.

Evaluation Factors

- CFD Analysis
- IT equipment inlet environmental conditions
- CRAC set points
- CRAC fan speed control
- CRAC intake chimneys
- Floor to ceiling height
- Design redundancy levels maintained

Implementation Guidance

Environmental control of VA data center spaces shall be based on the IT equipment requirements and not cooled for human comfort. Significant energy intensity reductions can be made by modifying these environmental control parameters and ensuring appropriate airflow paths and systems are designed, operated, and maintained. Retrofit all VA data center spaces for maximal energy savings as rapidly as feasible. Operate CRAC units only as required to maintain prescribed operational parameters.



4.3.7 Monitoring

Table 28: Monitored Conditions (MSC, CSC, and CDC)

ID	Primary Attribute	Secondary Attribute	Specification
1	Monitored Conditions	Fire Protection	<ul style="list-style-type: none"> VA telecommunications space fire protection systems shall be as required by the VA Fire Protection Design Manual. Where allowed by the AHJ, fire protection for CSCs and CDCs shall use an early-warning Aspirated Smoke Detection (ASD) system such as Very Early Smoke Detection Apparatus (VESDA).
		Water Detection	<p>All CDCs, CSCs, and MSC shall install a liquid water detection system in all data and infrastructure spaces (not required for NSCs). Required in:</p> <ul style="list-style-type: none"> Raised floor spaces IT spaces where water sources exist in or above electronic equipment HVAC chiller rooms Fire suppression system areas (pumps and controls)
		Power	<p>All data centers shall monitor continuity and quality of:</p> <ul style="list-style-type: none"> Utility power delivery UPS power output Auxiliary generator power output Branch circuit power output
		Temperature - Equipment Cabinets	<ul style="list-style-type: none"> All VA data centers shall monitor air temperatures at multiple points in IT equipment cabinets. Exact quantity and placement of sensors shall be determined according to the design and implementation of airflow management measures to ensure an adequate supply of cooling air All equipment cabinets in facilities lacking best-practice airflow management shall have at least four sensors per cabinet as per sensor location specification below



ID	Primary Attribute	Secondary Attribute	Specification
		Temperature - CRACs	<p>All VA data centers shall monitor supply air and return air temperatures:</p> <ul style="list-style-type: none"> • Supply air temperature shall be monitored at the output of each physical infrastructure device supplying cold air, whether the device is active or not • Return air temperature shall be monitored at the intake of each physical infrastructure device supplying cold air, whether the device is active or not
		Humidity - CRACs	<p>All VA data centers shall monitor supply air and return air Relative Humidity (RH):</p> <ul style="list-style-type: none"> • Supply air RH shall be monitored at the output of each physical infrastructure device supplying cold air, whether the device is active or not • Return air RH shall be monitored at the intake of each physical infrastructure device supplying cold air, whether the device is active or not
2	IT Equipment Cabinets	Temperature and Humidity Sensors	<p>To ensure an adequate supply of cooling air, all IT cabinets in facilities lacking best-practice airflow management shall have at least four temperature sensors per cabinet and one humidity sensor as per sensor location specification below</p> <p>IT Cabinets in facilities with best-practice airflow management may use fewer sensors, meeting the following minimum criteria:</p> <ul style="list-style-type: none"> • Sensors in cabinets at the ends of a contiguous row/string • Sensors in every third cabinet in the middle of a contiguous row/string • At least two sensors per monitored cabinet • Temperature sensors in the Front Middle (FM) and Rear Top (RT) locations • Humidity sensor in the FM location



ID	Primary Attribute	Secondary Attribute	Specification
		Sensor Locations	<p>IT Equipment Cabinet temperature sensor locations shall correspond to VA modified ASHRAE-recommended monitoring locations:</p> <ul style="list-style-type: none"> • Front Top (FT): Centered horizontally, inside the front door, no more than 1 ft from the top of the cabinet • Front Middle (FM): Centered horizontally, inside the front door, 4 ft +/- 6 in. from the finished floor surface • Front Bottom (FB): Centered horizontally, inside the front door, no more than 1 ft from the finished floor surface • Rear Top (RT): Centered horizontally, inside the rear door, no more than 1 ft from the top of the cabinet <p>One humidity sensor in the FM location</p>
3	Communication Protocols	IT Devices	<p>Monitored IT Devices shall use SNMP, configured in a secure mode as required by the TRM. Implementations shall adhere to the VA LAN Security Standard:</p> <ul style="list-style-type: none"> • SNMP v3.0 secured using SSL • SSL using Secure Hash Algorithm (SHA-1) authentication • Advanced Encryption Standard (AES) Encryption, at 128-bit or the highest level supported by the attached hardware
		Monitoring Systems	<p>To support data stream integration, monitoring systems shall support Secured SNMP v3.0 for upstream communication and at least one of the following industrial communication protocols to receive sensor data:</p> <ul style="list-style-type: none"> • BACnet or BACnetIP • Modbus or Modbus IP • CANbus or CANbus IP • Fieldbus or Fieldbus-IP
		Monitoring Devices	<p>Monitoring devices and systems shall be capable of communication using at least one of the following protocols:</p> <ul style="list-style-type: none"> • Secured SNMP v3.0 • BACnet or BACnetIP • Modbus or Modbus IP • CANbus or CANbus IP • Fieldbus or Fieldbus-IP



ID	Primary Attribute	Secondary Attribute	Specification
		Physical Infrastructure Devices	Infrastructure device communication modules shall support at least one of the TRM approved protocols: <ul style="list-style-type: none"> • Secured SNMP v3.0 • BACnet or BACnet IP • Modbus or Modbus IP • CANbus or CANbus IP • Fieldbus or Fieldbus-IP

Evaluation Factors

- Facility actively monitors all required monitoring points
- IT equipment rack temperature/humidity sensors installed as described in ISTS.
- Water detection system design
 - Point leak detection units
 - Zone leak detection panels
 - Linear detection systems
 - Wire-free sensors
 - DCIM integration
- Monitoring systems and equipment comply with communications protocol requirements

Implementation Guidance

IT equipment rack temperature/humidity sensors are required for MSC, CSC, and CDC data centers where there is separation between cold and hot air streams. Sensors are not required in TRs or entrance rooms where heat rejection is accomplished using the entire room as a heat sink.

Monitoring shall be defined as continual real-time observation of a condition or set of conditions affecting computing spaces.

Connect all vertical rPDUs to the rPDU monitoring system. Maximize connectivity of facility equipment within the data center to the rPDU monitoring system.

Provide output feeds from the system to the FMS building monitoring system for remote monitoring capabilities.

Functional definitions of monitoring and metering shall not be interpreted to require separate systems; a single sensor, device, or system may support multiple monitoring and metering functions.

Detection, alerting, and alarming functions, as well as automatic triggering of interventions, shall be considered part of a monitoring system.

Monitoring systems collect forensic data during a period when a detection threshold has been exceeded.



Alerts are communicated when a condition threshold has been reached or exceeded. Alert triggers shall be set to provide sufficient reaction time to respond to, investigate, and correct the underlying cause of the condition.

Alarming systems shall communicate when an absolute limit has been exceeded.

4.4 Telecommunications Standards

Work-Area Outlets (WAO), media, media connectors, and patch panels shall support the minimum performance and capacity requirements of this Standard.

All cabling system components shall be of the same performance category across each entire channel. Components typically may not be mismatched with respect to performance category. For example, where copper telecommunications cabling is used, all components – channel cabling, patch panels, jacks, receptacles, and patch cabling – shall have the same category designation. However, mixed environments are acceptable when supporting a planned upgrade path. For instance, Category 6A (Cat 6A) U/UTP patch cords can be used with Cat 6 patch panels knowing that the performance of the entire channel is at the capability level of the lowest performing component until the upgrade plan is complete.

The specifications for horizontal cabling for LAN applications and cabling for intra- and inter-building backbone are laser-enhanced fiber optics and high-bandwidth UTP. The minimum bandwidth requirement for fiber is 40 Gigabit Ethernet (GbE) and 10 GbE on UTP.

Media types not expressly authorized by this Standard are prohibited for use except for in the direct interconnection of IT equipment within the same enclosure.

IT equipment including both UTP data cabling and active equipment should not be operated in environments where an AC magnetic field level exceeds 12.6 milliGauss (1 A/m). Designers shall provide sufficient separation between EMI sources (i.e., transformers, electric motors) and IT equipment to meet this requirement.

Communications cabling must not be painted. Paint, plaster, cleaners, abrasives, corrosive residues, or other contaminants may result in an undetermined alteration of the cable properties.

Counterfeit communications cabling and termination hardware is a significant problem in the low-voltage industry. It puts entire projects at risk of post-installation performance failure across ISP and OSP infrastructures and it could potentially lead to fire risk since this media may not actually be certified for flame-spread or smoke toxicity. Furthermore, advertised performance ratings may not be achievable. Therefore, all telecommunications media specified and installed for VA projects must be listed by a Nationally Recognized Testing Laboratory (NRTL). The listing status of communications terminating hardware and media delivered to job sites must be confirmed through cross-referencing UL Solutions. UL Certification marks consisting of holographic labels or other verifiable NRTL marks prove that these products are not counterfeit and meet applicable performance and safety ratings prior to unboxing and installation.



Note: Signal cable consisting of copper-clad-steel and copper-clad-aluminum is not permitted for use in VA projects. It is incumbent upon VA staff with authority over any given project to confirm and document ongoing compliance.

This Standard has been harmonized with OIT LAN Baselines.

4.4.1 Structured Cabling

This Standard requires structured cabling as a vendor-neutral, extensible approach to information transport system design in VA facilities, *not limited to data center applications*. All local and campus area networks shall be installed in a structured topology with patch panels serving transition points. Individual “home run” cables are not permitted for LAN applications, including data centers. VA employs a single converged physical telecommunications infrastructure model to support all the telecommunications needs of all consumers of these services at a single campus or facility. Installed cable plant systems (both ISP and OSP) are designed and intended to be shared among the multiple possible users (OIT, CE, FMS, VA police, etc.). Individual projects for systems for any user at the campus or facility shall follow the structured backbone and horizontal distribution model described in these Standards, use equipment and components described in Division 27 specifications and these Standards, utilize already-installed backbone media where it is compliant with these Standards, and follow established OIT processes for isolation architectures to reduce operational risks both to user systems and to the VA network.

New cable plant systems that are not part of the converged physical telecommunications infrastructure are prohibited.

Installation of new equipment and/or systems intended to use legacy cable plant systems rather than the converged physical telecommunications infrastructure are prohibited. All new equipment and/or systems shall, where feasible, be designed and installed to use the converged physical telecommunications infrastructure. Variances may be granted where these systems operate on physical media or protocols that cannot utilize the converged physical telecommunications infrastructure (e.g., coaxial cable).

Legacy cable plant systems (e.g., telephony Cat 3 station cabling, telephony distribution frames, dedicated fiber backbone elements serving specific systems) shall be abated during any modernization project work, including replacement of active equipment being served by the legacy media.

Structured cabling requirements shall be accounted for in all projects impacting the telecommunications infrastructure. Data Center and Infrastructure Engineering are stakeholders in every project involving the physical cable plant installed at a campus or facility, including CE, FMS, and VA police projects that intend to install additional cable plant media, and shall be included in project review to ensure compliance with the converged physical telecommunications infrastructure model.



4.4.1.1 Campus Structured Cabling

In general, fiber optic backbone directly connects the entrance rooms and antenna entrance rooms to the data center's MDAs and the data center MDAs to the TRs. Pathway redundancy requirements are based on the classification archetype of the data center.

Due to a broadly-demonstrated inability to effectively manage and maintain them, the use of Intermediate Cross-Connects (ICCs) between the MDAs and TRs is prohibited in VA campus structured cabling systems.

In general, copper UTP horizontal distribution connects the TRs to the end-user WAOs.

Field termination of media is expected for campus structured cabling systems.

Any differing approaches (e.g., use of fiber optic media for horizontal distribution, or of a Passive Optical Network (PON) to support a campus or part of a campus) to the campus structured cabling must be approved in writing by Data Center and Infrastructure Engineering.

4.4.1.2 Computer Room Structured Cabling

Data center structured cabling systems are required in the MSC, CSC, and CDC facility classifications. This approach is consistent with ITS industry standards, and it supports the SD LAN and data center network design baselines.

These structured cabling systems shall use a redundant, diversely-routed end-of-row (EOR) HDA distribution model supported by redundant MDAs where the main cross-connect is located as defined by ANSI/TIA 942-B specifications.

All elements of these data center structured cabling systems shall be located in the data center installed in overhead cable tray systems. Both HDAs, which serve as the distribution point for horizontal cabling and houses horizontal cross-connects and equipment for connecting to the equipment distribution area and the MDA, should be located adjacent to switching components within the rack to minimize patch cord length and cable management requirements.

All IT equipment will be supported from the HDA elements using the structured cabling system. All networking equipment will be located in the network channel racks and all server/storage equipment will be located in the server cabinets provided in these designs. NSCs using a server cabinet shall follow a modified structured cabling environment appropriate to the specific requirements of the environment.

The use of top-of-rack (TOR) switches and similar networking equipment within server cabinets is prohibited.

The use of pre-terminated structured cabling elements is required in the data center. Specification of data center structured cabling (both copper and fiber) requires calculation of total length of the link pathway in all dimensions (orthogonally) from dimensionally accurate plans. Procure structured cabling elements to not exceed 6 ft (2 m) at each end from the calculated length to avoid coiling of excess cabling.

Media and patch panel quantities for the computer room structured cabling system are based on the Standard Density server cabinet. Equipment Distributors in standard density server



cabinets support A/B redundant cabling with each side consisting of a minimum of 12 duplex LC (two 12-strand MPO cables) and a minimum of 24 UTP cables. Upstream requirements in HDAs and MDAs are based on the quantity of server cabinets in the data center’s master plan.

4.4.2 Unshielded Twisted Pair

This Standard specifies pre-terminated Category 6A (Cat 6A) U/UTP for horizontal distribution. This performance category is applicable to field-terminated or factory pre-terminated cabling for UTP with each cable terminating in an individual connector. While pre-terminated cables require that distances between termination points are known this approach results in the rapid installation of horizontal cabling without risks associated with field termination including wire fragments, impaired cabling performance due to poor installation techniques, faulty terminations, etc. Spiral wrapping pre-terminated bundles is an effective way to maintain the bundle of six cables without impacting ease of installation.

Factory pre-termination is the preferred termination method, but field-termination is acceptable for work-area distribution applications and where pre-termination is impractical such as in horizontal distribution from TRs.

Cat 6A cabling is specified in standard ANSI/TIA-1179 Healthcare Facility Telecommunications Infrastructure for new installations.

Copper Clad Aluminum (CCA) cable is not permitted.

Table 29: Unshielded Twisted Pair Standards

ID	Primary Attribute	Secondary Attribute	Specification
1	Performance Characteristics (Horizontal and First Level Backbone)	Performance Category	<ul style="list-style-type: none"> Cat 6A (10 GbE) Cat 6 (exempted and authorized variance only)
		Performance Specifications	Meets or exceeds TIA-EIA-568.2-D and TSB-155
		Conductor Size	22 AWG to 24 AWG
		Limited Power (LP) Certification	UL Listed as x-LP (0.5 A)
		Termination Method	<ul style="list-style-type: none"> Pre-terminated, 8P8C with TIA-568-B termination method preferred, OR Field-terminated with TIA-568-B termination method where distances cannot be precisely calculated
		Cable Length	Pre-terminated cables not to exceed 6 ft (2 m) of excess length on each end



ID	Primary Attribute	Secondary Attribute	Specification
		Media Connector	<ul style="list-style-type: none"> • 8P8C • Modular Plug Terminated Link (MPTL) authorized for media connecting to Wireless Access Points (WAPs)
		Bundling	Multiple cable harness

Evaluation Factors

- Performance category tuned to match all channel components
- Performance characteristics
- Conductor size
- Termination (factory or field)
- PoE
- Compatibility with specified patch panels
- Combustion rating

Implementation Guidance

Category 6A UTP is required for all new installations for clinical spaces to meet ANSI/TIA-1179 and 10 GbE performance objective.

Cat 6 UTP may be specified for installation for strictly administrative areas with an approved variance from DCIE (see Appendix A:).

Retrofit/replacement decision points to meet minimum 1 GbE objective on legacy cable plant:

- Cat 5e replacement with Cat 6A strongly recommended
- Interim full testing of Cat 5e channels to verify 1 GbE performance.
- Cat 5 or below – replacement with Cat 6A required
- Failed Cat 5e permanent link test – Interim repair, replacement with Cat 6A required

Horizontal channel distance for UTP is limited to 90 m with 10 m reserved for patch cords.

Pre-termination requires that distances between termination points are known; however, it assures maximum performance and rapid installation. Only use field terminations to WAOs

Distribution to WAP locations may be terminated Modular Plug Terminated Link (MPTL) rather than using 'biscuits,' eliminating the requirement for a connecting patch cord.

Shielded twisted pair media (e.g., STP, FTP, S/FTP) are not recognized to have any applicable use cases in typical usage in VA telecommunications systems. In addition to requiring specific additional interface equipment, having a higher procurement and installation cost, and requiring bonding beyond the requirements for UTP, VA configuration management and maintenance capabilities are insufficient to ensure that the intended purpose of these types of media can be sustained.

Over the past decade, power-over-LAN cable technologies such as PoE have become a viable powering option for a wide range of applications. Anticipating future standards, device



manufacturers are pushing the envelope and designing more sophisticated equipment that demands increased power. As the power is increased, the heat generated within the cable increases as well. This is especially true when the cables are bundled. The additional heat generated by the increased current could push the cables beyond their rated temperatures. To address this concern, UL has introduced a Limited Power (LP) certification to simplify the cable choice and installation considerations. The “-LP” cable designation indicates that the cable has been evaluated to carry the marked current under reasonable worst-case installation scenarios without exceeding the temperature rating of the cable. The certification accounts for large bundle sizes, high ambient temperatures, and other issues related to environmental effects, such as enclosed spaces or conduits. If LP certified cable is not used, the number of cables that can be bundled or enclosed in a sealed raceway will be limited per the specifications in the associated NEC ampacity chart.

Where practicable, this Standard recommends Cat 6A UTP with a minimum LP rating 0.5 to support PoE technology up to 100 W. This specification is shown as “UL Listed as x-LP (0.5 A).” If running Type 4 PoE, cables without LP certification are subject to inspection to ensure bundle size and current limitations per the NEC ampacity table are not exceeded.

See Sections 4.4.1 and 5.3.2 on cable routing and implementation.

4.4.3 Unshielded Twisted Pair Patch Panels

Patch panels shall serve as transition points for all horizontal cabling in equipment distributors and horizontal distributors and throughout the MDAs for all backbone and horizontal levels.

This Standard anticipates the bandwidth demands of virtualization by specifying Cat 6A UTP in production and test facilities. This Standard can be applied to field-terminated or factory pre-terminated applications. The preferred termination method is factory pre-terminated cabling for UTP. Cat 6A cabling is specified in standard ANSI/TIA-1179 Healthcare Facility Telecommunications Infrastructure for new installations.

Modularity of structured cabling components in the TRs, entrance rooms, and data centers improves capacity planning and move/add/change outcomes. This Standard specifies a one-RU high, 24 or 48 position patch panel that is performance-tuned to the UTP. Angled panels eliminate the need for horizontal cable management in the rack and are the typical configuration. No horizontal cable management is required when specifying angled panels.

Table 30: Unshielded Twisted Pair Patch Panel Standards

ID	Primary Attribute	Secondary Attribute	Specification
1	Performance Characteristics	Performance Category	<ul style="list-style-type: none"> Cat 6A (10 GbE) Cat 6 (exempted and authorized variance only)
		Position Count	24/48



ID	Primary Attribute	Secondary Attribute	Specification
		Form Factor	<ul style="list-style-type: none"> • 1 RU • Angled
		Components	<ul style="list-style-type: none"> • Angled panel cover • Rear cable manager

Evaluation Factors

- Performance category tuned to match all channel components
- Form factor
- Compatibility with pre-terminated cable interfaces
- Channel installations (including patch panel equipment on each end) certified to media performance category using level IIIe test equipment per ANSI/TIA-1152

Implementation Guidance

Patch panels shall serve as transition points for all horizontal cabling in equipment distributors and horizontal distributors, and throughout the MDAs for all backbone and horizontal levels. The patch panels at the HDA and MDA shall be located in the same rack with the switching components to minimize patch cord length and cable management requirements.

Where installed, the ED patch panels will be installed in the top five rear RUs of each enclosure or within small (five RUs or fewer) pathway racks mounted on cable tray above the associated equipment cabinet.

4.4.4 Unshielded Twisted Pair Patch Cord

This Standard specifies center-tuned Cat 6A (or Cat 6 exempted and authorized variances only) patch cords. This Standard does not specify color-coding for patch cord jackets. Based on the observations of hundreds of VA facilities, color-coded patch cords provide little or no utility and create inventory management issues. Effective color coding has been observed for in-rack, dual-homed server/appliance applications using a simple white/black scheme. Patch cords shall be factory pre-terminated and shall match or exceed the category of the associated patch panel and connected UTP.

Table 31: Unshielded Twisted Pair Patch Cord Standards

ID	Primary Attribute	Secondary Attribute	Specification
1	Performance Characteristics	Performance Category	<ul style="list-style-type: none"> • Cat 6A (Cat 6 exempted and authorized variance only) • Stranded



ID	Primary Attribute	Secondary Attribute	Specification
		Jacket Color	Not specified
		Termination Method	Factory pre-terminated
		Conductor Size	22 AWG to 28 AWG

Evaluation Factors

- Performance category tuned to match all channel components
- Performance characteristics
- Center-tuned to installed patch panels
- Patch cords of shortest appropriate length used

Implementation Guidance

Use most appropriate length to meet cable management standards.

The use of 28 AWG cords is allowable; however, the reduced overall horizontal channel distance and other factors must be considered when used:

- Total allowable patch cord length is reduced from 32 ft (10 m) to 20 ft (6 m) (see Table 1. ANSI/TIA-568.0-E)
- The total channel (patch cords plus permanent link) length maximum is, therefore, reduced from 321 ft (98 m) to 315 ft (96 m)
- The maximum bundle size (cables and cords bundled together with hook and loop straps) is twelve (see Annex Q. TIA-568.2-D-2)
- Per VA and industry standards concerning DC powering over UTP, Category 6A 4-pair balanced twisted-pair cabling as specified in ANSI/TIA-568.2-D is required media for the permanent link (see Annex A. TIA TSB-184-A)
- The patch cord performance category must meet or exceed the performance of the permanent link (regardless of patch cord OD). Maximum individual patch cord length is limited to 10 ft (3 m) to eliminate use of patch cords for horizontal or backbone connectivity.

ISP design best practices dictate that component-level compliance to a performance standard must be maintained across the entire horizontal link. The quality of patch cords and adherence to performance standards is critical to the reliable operation of a high-speed LAN.

4.4.5 Fiber Optic Cable

This Standard specifies laser-optimized Optical Multimode (OM) OM4- and OM5-rated Multimode (MM) fiberoptic cable primarily for ISP use.

OM4 is primarily used to support single-pair 10 GbE, four-pair 40 GbE or ten-pair 100 GbE, access-layer to aggregation or core layers. Typical intra-building backbone between TRs and



MDAs will consist of a minimum of two diversely routed 24-strand cable assemblies from both A- and B-side MDAs and two 12-strand Single-mode (SM) cables to both A and B as required by the LAN baseline.

OM5 is designed to support Short Wavelength Division Multiplexing (SWDM) where switch transceivers can support 40 Gigabit per second (Gb/s) and 100 Gb/s on two fibers. OM5 is included in this Standard for specialized data center applications only.

In backbone distribution, field selectable OS1 or OS2 SM 12/24-strand fiber optic cable assemblies using Multi-fiber Push On (MPO) connectors are specified. Typical intra-building backbone between TRs and MDAs will consist of a minimum of two diversely routed 12-strand cable assemblies for path diversity from both A and B MDAs as required by the LAN baseline. However, if intra-building distances exceed the OM4 limit and only SM is used, then two 24-strand cable assemblies are required.

OS2 12/24-strand indoor/outdoor rated assemblies SM fiber optic cable is primarily used for OSP and long-distance transmission for requirements exceeding the capabilities of MM fiber. Additionally, it is necessary for some special systems and for intra-building as well as inter-building connectivity. Typical inter-building backbone will consist of a minimum of two diversely routed 24-strand cable assemblies from both A and B MDAs as required by the LAN baseline. Where separate buildings are serviced with SM fiber, each TR in that building requires the minimum redundant SM cable distribution.

Factory pre-termination is the preferred termination method, but field-termination is acceptable for work area distribution applications and where pre-termination is impractical such as in horizontal distribution from TRs. Pre-termination requires that distances between termination points are known; however, it assures maximum performance and rapid installation.

If fiber media is required for horizontal distribution to WAO, a structured approach is required. A stated need for fiber to work WAOs should be scrutinized by the planner and justified by sound technical requirements. This application must be approved in writing by DCIE via a variance request.

Table 32: Fiber Optic Cable Standards

ID	Primary Attribute	Secondary Attribute	Specification
1	Multimode	Performance Category	<ul style="list-style-type: none"> OM4 (horizontal and backbone) OM5 (specialized data center applications)
		Performance Specifications	Laser Optimized 50/125 μm fibers with minimal effective modal bandwidth of 4,700 MHz·km at 850 nm



ID	Primary Attribute	Secondary Attribute	Specification
		Combustion Rating	<ul style="list-style-type: none"> • Communications Riser (CMR) rated for vertical runs through floors • Communications Plenum (CMP) rated for plenum spaces • Communications (CM) minimum jacket rating suitable when riser or plenum are not required • Or as per AHJ requirement
		Jacket Color	Refer to the TIA standard
		Termination Method	<ul style="list-style-type: none"> • Factory pre-terminated (computer room structured cabling use) • Field terminated (connections between telecommunications spaces)
		Media Connector	LC/Angled Physical Contact (APC), Ultra Physical Contact (UPC), or as required by application
		Strand Count	<ul style="list-style-type: none"> • 12 or 24 per assembly • Constructed in strand bundles of 6 or 12 for compatibility with specified splice cassettes
		Cable Length	Cables not to exceed 6 ft (2 m) of excess length on each end
		Bundling	Dielectric, Tight Buffered
		Polarity	<ul style="list-style-type: none"> • Straight (or Type A-Key up one end & key down on the other) • Type B with “universal” cassettes
2	Single Mode	Performance Category	OS1/OS2 to be field selectable)
		Performance Specifications	Laser Optimized 9/125 μm with effective modal bandwidth of at least 850 MHz·km at 1310 nm



ID	Primary Attribute	Secondary Attribute	Specification
		Combustion Rating	<ul style="list-style-type: none"> • Riser cable for vertical runs through floors • Plenum rated for plenum spaces • Tight-buffered for OS1 • Loose-tube gel-filled for OS2 riser rated when used for OSP indoor/outdoor transition • Or as per AHJ requirement
		Jacket Color	Yellow
		Termination Method	<ul style="list-style-type: none"> • Factory pre-terminated (computer room structured cabling use) • Field terminated (connections between telecommunications spaces)
		Media Connector	MPO or LC (application dependent)
		Strand Count	<ul style="list-style-type: none"> • 12 or 24 per assembly • Constructed in strand bundles of 6 or 12 for compatibility with specified splice cassettes
		Cable Length	Cables not to exceed 6 ft (2 m) of excess length on each end
		Bundling	Dielectric <ul style="list-style-type: none"> • Tight-Buffered – ISP Use • Loose-Tube Gel-Filled – OSP Use
		Polarity	<ul style="list-style-type: none"> • Straight (or Type A-Key up one end & key down on the other) • Type B with “universal” cassettes

Evaluation Factors

- Warranty
- Performance category tuned to match all channel components
- OM4 performance characteristics for up to 10 GbE intra-building backbone
- OM5 performance characteristics for data center distribution for specialized application
- SM performance characteristics for vertical backbone OS1 or OS2 to be field selectable for inter-building backbone and OSP
- Combustion rating requirements
- Technical requirements for inclusion in horizontal distribution to the WAO



Implementation Guidance

Dual 24-strand OM4 50/125 MM and dual 12-strand field selectable OS1/OS2 SM per TR with path diversity will support most small/medium capacity distribution needs. Some larger TRs may require additional fiber counts.

Pre-termination requires that distances between termination points are known; however, it assures maximum performance and rapid installation.

This Standard specifies the polarity of horizontal pre-terminated MPO-based fiber optic cabling as Type A (straight-through) or Type B with 'universal cassettes' for LC cassette breakout. If a polarity flip for the channel is necessary, use a Type A/A patch cord on one end and a Type A/B patch cord on the other end. In some cases, an A/B cord can be converted to an A/A by switching the connector position on one end of the patch cord. Type C polarity is not authorized.

There should be two simultaneous A/B redundant, diverse distribution paths minimally to all TRs in clinical spaces. Diverse path routing is also required for the service provider circuits to diverse entrance rooms and within the data center between the equipment distributors and HDAs, and between the HDAs and the MDAs. Path diversity to administrative spaces should have diverse distribution paths wherever possible. Where not possible, media should not be in the same conduit.

MPO-8 cassettes for SR4 should be planned directly with the distribution designer or DCIE.

See Sections 4.4.1 and 5.3.2 on cable routing and implementation.

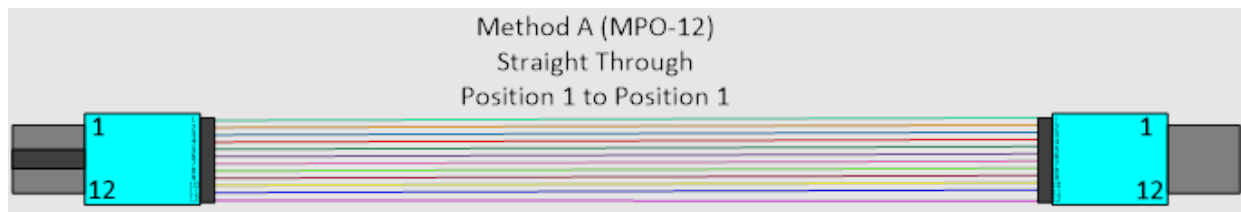

Figure 23: Method A Polarity of Horizontal Pre-terminated MPO-based Fiber Optic Cabling

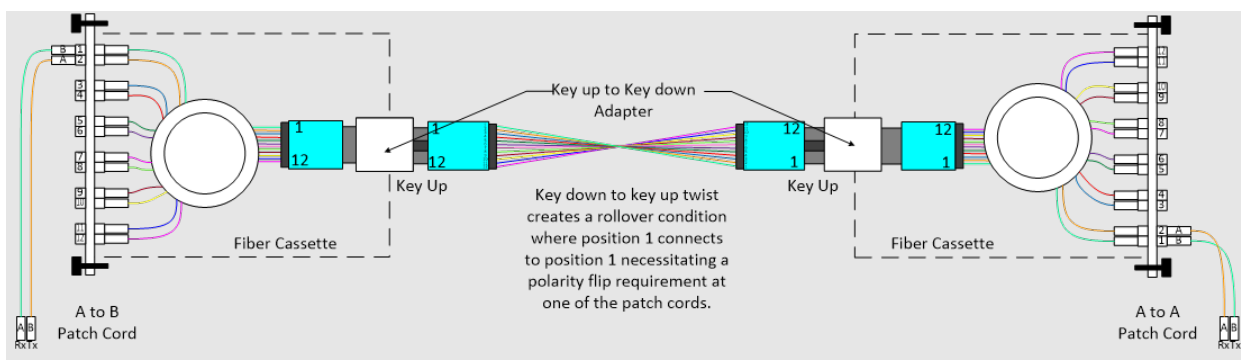

Figure 24: Method A Polarity End to End Connectivity (A-B and A-A Patch Cords Required)



4.4.6 Fiber Distribution Cassettes

This Standard specifies the transition component of the structured cabling system for fiber optic cabling in telecommunication spaces. It is the fiber equivalent to UTP patch panels. This Standard specifies 12/24-strand, OM4- or OM5-rated MM cassettes for ISP and use SM cassettes for SM applications. The cassette will be equipped with dual, 12-strand or single 24-strand MPO interfaces as the backbone or horizontal interface.

Table 33: Fiber Distribution Cassettes

ID	Primary Attribute	Secondary Attribute	Specification
1	Performance Characteristics	Form Factor	1 RU
		Capacity	3-12 cassettes
		User Interfaces	LC connectors (6/12 duplex per cassette) MPO connectors (8 fibers)
		Backbone Interfaces	12-strand or 24-strand MPO (50 micron)
		Type	OM4 Laser Enhanced 10 GbE or OM5 Laser Enhanced 50/125 Multimode to match media

Evaluation Factors

- Performance category tuned to match all channel components
- Performance characteristics
- Form factor
- Interfaces
- Channel installations (including cassette equipment on each end) certified to Tier I and Tier II performance standards

Implementation Guidance

This Standard specifies Optical Multimode-4 and -5 (OM4 and OM5) rated 850 nm laser-enhanced multi-cable fiber cable assemblies pre-terminated with MPO connectors. One cassette will be used to provide LC interfaces at both ends of the horizontal or backbone link and will support one or two 12-strand cable assemblies or one 24-strand cable assembly for a total capacity of 6 or 12 duplex LC interfaces. Cassettes can also be used to breakout 24-strand MPO backbone trunks into three MPO connections of eight fiber strands.



4.4.7 Fiber Patch Cords

This Standard specifies high-bandwidth, factory pre-terminated fiber patch cords. The standard media interface for fiber patch cords is duplex LC. Patch cord polarity requirements can be accommodated by specifying a polarity-reversible duplex interface or by using universal cassettes. When polarity requirements are not known, the polarity-reversible duplex LC interface should be specified.

Table 34: Fiber Patch Cord Standards

ID	Primary Attribute	Secondary Attribute	Specification
1	Performance Characteristics	Performance Category	<ul style="list-style-type: none"> OM4 OM5 (used only for specific data center applications (see Section 4.4.1))
		Performance Specifications	Laser enhanced, 50/125 MM fiber, Duplex LC
		Jacket Color	Refer to TIA standard
		Termination Method	Factory pre-terminated
		Polarity	<ul style="list-style-type: none"> Type A/A (Straight) or Type A/B (Crossover) as required

Evaluation Factors

- Performance category tuned to match all channel components
- Polarity reversibility
- Performance specifications

Implementation Guidance

ISP design best practices dictate that component-level compliance to a performance standard must be maintained across the entire horizontal link. The quality of patch cords and adherence to performance standards is critical to the reliable operation of a high-speed LAN or SAN.

The polarity of the fiber optic channel may need to be flipped depending on the application. This will ensure that the equipment sending or transmitting will be connected to the receiving port of the equipment at the other end. If typical A/B fiber patch cords are used on both sides of the channel, continuity may be lost. As shown in Figure 25 below, this is corrected by either switching the connector position of both strands at one end of the patch cord or by using a Type A/A patch cord on only one end of the channel.

Pre-termination requires that distances between termination points are known; however, it assures maximum performance and rapid installation.

See Sections 4.4.1 and 5.3.2 on cable routing and implementation.



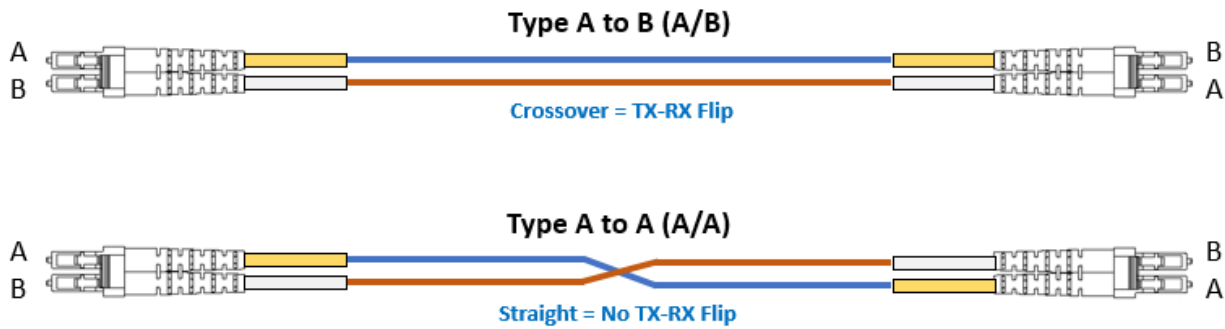

Figure 25: Polarity of Fiber Optic Patch Cord

4.4.8 Fiber Distribution Panel/Cabinet

This Standard specifies a one RU panel for mounting fiber cassettes. The smallest form-factor has been selected for application flexibility.

Table 35: Fiber Distribution Panel/Cabinet Standards

ID	Primary Attribute	Secondary Attribute	Specification
1	Performance Characteristics	Form Factor	1 RU
		Cassette Capacity	3-12 cassettes
		Type	<ul style="list-style-type: none"> • Cabinet • Panel

Evaluation Factors

- Form factor
- Cassette capacity
- Locking requirements

Implementation Guidance

ED Fiber Distribution Panels will be installed in the top RU (RU44 or RU45) of each server cabinet where required.



4.4.9 Cable Support Infrastructure

This Standard creates uniform high-capacity horizontal and vertical cable management for Cat 6A patch cords.

Table 36: Cable Support Infrastructure Standards

ID	Primary Attribute	Secondary Attribute	Specification
1	Horizontal Cable Management Panels	Form Factor	<ul style="list-style-type: none"> • 1 RU (up to 50 Cat 6A patch cords) • 2 RU (up to 100 Cat 6A patch cords)
		Cover	Double-hinged
		Finger Spacing	To meet requirements; typically, 6-port spacing (five fingers)
2	Vertical Cable Management Panels	Door	Double-hinged
		Dimensions	6 in. to 16 in.

Evaluation Factors

- RU Finger spacing
- Double-hinged cover capacity

Implementation Guidance

Vertical cable management will be utilized for the HDA and the MDA. Horizontal cable management within the rack will be utilized as necessary to encourage defined and traceable routing of individual patch cords from switches to the vertical cable managers.

4.4.9.1 Cable Distribution

This Standard offers consistency in the construction characteristics of overhead cable tray to achieve common mounting, hanging, support, bonding, and interconnecting features for the benefit of data center and ITS designers and end-users.

Network cable distribution should be distributed in overhead cable trays in all new installations when overhead space allows. Existing underfloor cable trays will be phased out during major upgrades to existing data centers and ITS.



Table 37: Cable Distribution Standards

ID	Primary Attribute	Secondary Attribute	Specification
1	Cable Tray	Design	Wire Basket
		Capacity	<ul style="list-style-type: none"> Maximum fill ratio not to exceed 50 % Depth of telecommunications cables not to exceed 6 in.
		Bonding Kit	Mechanically bond cable pathway sections and trays to one another and to the Supplemental Bonding Network in accordance with ANSI/TIA-607-D
		Clearance	<ul style="list-style-type: none"> 2 in. from top of cable tray to bottom of access floor in legacy underfloor installation 6 in. clearance between cable trays in stacked overhead installations Media types will be segregated
		Installation	Per manufacturer’s recommendations
		Intended Use	Applications in the horizontal (X,Y) plane
2	Fiber Raceway	Design	Rigid plastic, modular, nominally 4 in. x 4 in.
		Intended Use	Applications in the horizontal (X,Y) plane in MSCs, CSCs, and CDCs
		Installation	Per manufacturer's recommendations
3	Ladder Rack	Design	12 in. width steel or aluminum ladder with stringers and cross members
		Intended Use	Applications in the vertical (Z) plane
		Installation	Per manufacturer's recommendations

Evaluation Factors

- Wire-basket construction
- Toolless joining kits
- ASTM coating

Implementation Guidance

Cable pathways shall meet the clearance requirements of fire detection, suppression, and prevention systems, and these systems must be coordinated with other systems (e.g., electrical, mechanical, telecommunications) and meet the requirements of the manufacturer and the AHJ.



Cable tray in MSC, CSC, and CDC facility classifications is intended to support UTP distribution only, with fiber optic distribution to be in fiber optic raceways.

If both power and telecommunications cabling are distributed from below the access floor, then:

- The power cabling should be routed either adjacent to or within the cold aisle
- The telecommunications cabling should be routed adjacent to or within the hot aisle
- Power and communication pathways should be positioned at different heights off the floor so that they can cross each other without interference. Alternatively, at every point where the power and copper cabling cross the path of each other, the crossing should be at a right (90-degree) angle

4.4.10 Work Area Outlets

Work Area Outlets (WAOs) are user interfaces to the cabling system within a workspace, floor, or building. Each telecommunications outlet/receptacle connected by media to a patch panel in the supporting TR is considered a single WAO, so a faceplate at an end-user location may typically have two WAOs.

This Standard specifies the typical quantity and type of faceplate, wall box, conduit, and outlets for typical administrative work areas. However, this guidance does not preclude variations based on atypical capacity requirements nor does it supersede guidance or requirements set forth by CFM concerning WAO specifications for specialized spaces.

Typical in-wall work boxes shall be a single-gang telecommunications-rated work box with rigid conduit extending to the horizontal pathway.

Floor boxes shall be single-gang or “poke-thru” type. Cable that extends through a slab penetration shall terminate in the nearest practicable TR on the same serving floor.

The typical standard density work area telecommunications data faceplate will consist of two RJ45 interfaces (two WAOs). This provides both redundancy and support for future equipment requirements. IP phone systems used in VA shall have gigabit throughput capabilities and be connected in-line between the WAO and workstation. This allows the workstation to interface with the network via the phone base at the full planned bandwidth of the horizontal channel media and leaves one RJ45 at the faceplate available for future use.

Evaluation Factors

- Serving zone capacity requirements
- Special safety, desktop support, or medical device requirements

Implementation Guidance

WAO media interfaces shall be tuned to the horizontal media, specified to the same performance rating, and installed according to best practices.

No RJ-11 “phone outlets” are specified in this Standard. A second gang with outlets for analog telephony purposes are acceptable.



Single-outlet posted faceplates shall be configured with one RJ45 interface. The high-density WAO configuration consists of four RJ45 interfaces. This configuration is typically used for desktop support and other technical staff or in cases where multiple devices need network access from the same WAO.

4.4.11 Horizontal Distribution

Horizontal distribution is defined as structured cabling that connects the WAO or the equipment distributor to a horizontal distributor. The horizontal distributor will be located in the end of row HDA in a computer room or in a TR depending on the application.

Horizontal media shall be specified per Section 4.4.1. If the application, such as a data center, requires fiber, specify the media per Section 4.4.5.



4.4.12 Fiber Optic Backbone Distribution

Backbone distribution is defined as structured cabling that connects the horizontal distributor to the Main Distributor (MD). The MDA will be located in a centralized location within the building, data center, or LAN serving area. Typically, this will be in the computer room.

The A-side and B-side MDAs shall be separate and distinct telecommunications spaces within the LAN serving area. It is preferred that the MDAs are built in separate locations, but they can be combined into one space. The MDAs shall not be located in a TR.

Campus fiber optic backbone distribution shall be diversely routed to each TR and entrance room from the A/B redundant MDAs. Administrative and healthcare buildings require full backbone diversity and redundancy as described. Buildings with strictly craft, maintenance, or service purposes (e.g., laundry, physical plant, trade shop) may be supplied with a single backbone path.

This Standard only recognizes 50/125 Laser-Enhanced Multimode (OM4 and OM5) and 9/125 Single Mode (OS1 and OS2) as acceptable backbone media (see Section 4.4.5).

UTP shall be utilized only if fiber media cannot serve specialized applications such as legacy phones, fax machines, or security panels. Where copper backbone is required, this Standard specifies quantity two riser-rated Cat 5e, 25-pair cables to be installed between the TR HDA and the MDA. This approach will support 12 patch panel positions. One 12-position Cat 6 patch panel shall be installed in the HDA and the MDA. Individual 4-pair Cat 6 riser-rated cables may be used, but this approach is not recommended and will require technical review by DCIE.

Criteria requirements for diverse path backbone:

- Supports VA clinical staff function in a healthcare setting
- Supports VA clinical-supporting staff function with end-user desktop and/or VOIP phone requirement
- Supports VA administrative staff function with end-user desktop and/or VOIP phone requirement (reduced fiber count routing may be considered if space cannot be used for a healthcare/clinical function, e.g., Washington DC administrative buildings, VBA regional office buildings)
- Not required for patient-only areas without any VA staffing function presence (non-diverse and reduced fiber count routing may be considered)
- Not required for VA technician, maintenance, or trades areas or facilities (non-diverse and reduced fiber count routing may be considered)

4.4.12.1 Intra-building

4.4.12.1.1 Multimode

This standard specifies Laser Optimized 50/125 OM4 required for new installations to meet single-pair 10 GbE objective.

Replace or retrofit the following legacy cable:

- Laser Optimized 50/125 (OM3 is exempted; OM4 for all tech refresh projects required)



- 62.5 core (OM1) – replace
- Non-optimized (OM2) – replace

4.4.12.1.2 Single Mode

This standard specifies 9/125 field selectable OS1 or OS2 MPO for intra-building SM application.

SM may be required for backbone distribution in support of specialized applications, such as DAS.

4.4.12.2 Inter-building

Inter-building backbone shall not transition at an intermediate cross-connect. Therefore, the MDA will connect directly to each TR in all campus buildings outside of the computer room building.

For all inter-building connectivity, 9/125 indoor/outdoor rated OS2 SM fiber will be utilized. when paths are outside of MM range and not connected by environmentally protected conditioned spaces.

4.4.13 Copper Backbone Distribution

Copper backbone is intended to provide the broadest amount of flexibility in supporting analog telephony, single-pair ethernet, building automation, and other, non-ethernet future applications. Copper backbone replaces Cat 3 legacy station cabling and the Main and Intermediate Distribution Frames (MDFs and IDFs) used for analog and POTS telephony distribution, as the sunset of local-loop copper-based infrastructure and replacement of Private Branch Exchange (PBX) telephone systems with VoIP systems require modern approaches and equipment.

Install non-redundant Cat 5e-rated 25-pair 24 AWG copper backbone from a Main Distribution Area (MDA) in the facility computer room to each distributed TR on the campus. Install additional backbone to TRs where the TR's serving zone is identified to require more than 24 connections. Install a minimum of two each 25-pair trunks between the computer room and the entrance room where POTS lines demarcate from the service provider.

Copper backbone and equipment is specified to be rack-mounted (as opposed to wall-mounted) on each end allowing direct patching to horizontal media and future systems.

Typical termination will use pins 4 and 5 of the RJ45 connector, following the T568B standard (solid/striped). Terminate the first port of each 24-port patching element with pins 3, 4, 5, and 6 to connect the 'extra' backbone pair.

4.4.13.1 Intra-building

Terminate backbone to 24-port UTP patch panels at the TR end and 48-port UTP patch panels at the computer room end.

Lightning surge protection is required at the facility antenna entrance room where transients could be generated and transmitted back to the computer room.



4.4.13.2 Inter-building

Terminate backbone to 24-port UTP patch panels on both ends.

Lightning surge protection is required when copper backbone transits OSP pathways that could expose the conductors to electrical transients. For copper backbone applications where surge protection is required, use only flat (not angled) 24-port patch panels. Adjacent to each 24-port UTP patch panel requiring protection, install 1U rack-mount 24-position surge protector equipment.

4.4.14 Server Cabinets

VA designs and implements telecommunications spaces fully built out with IT equipment enclosures, power, cooling, and structured telecommunications cabling. Install all IT equipment in these standard enclosures following the VA structured cabling model.

Because of this design philosophy, during post-commissioning lifecycle, vendor-provided server cabinets, wall-mounted enclosures, and similar are not required and are not accounted for in telecommunications space layouts intended for “roll-in” spaces for future vendor-provided enclosures. Do not plan, specify, order, or install additional vendor-provided enclosures for installation into the master-planned, built-out data center.

These specifications define a standardized server enclosure with sufficient depth to accommodate active hardware and cable management.

Table 38: Server Cabinet Standards

ID	Primary Attribute	Secondary Attribute	Specification
1	Dimensions	Height	7.5 ft maximum
		Width	<ul style="list-style-type: none"> • 24 in. • 30 in. permitted in groups of four to maintain alignment with floor tiles in raised floor environments only
		Depth	48 in. nominal with all doors and accessories installed
		Rack Units	44/45
2	Design	Rails	<ul style="list-style-type: none"> • Square-punched (two pair = front + rear) • Toolless adjustable • Rear rails installed with not less than six in. clearance to inside of rear cabinet doors to accommodate ED patch panels
		Rack Marking	Present on front and rear rails graduated starting with RU1 from the bottom
		Static Capacity	2,500 lb minimum



ID	Primary Attribute	Secondary Attribute	Specification
		Color	White or existing match
		Bonding Connection	Doors, frame, and side, top, and bottom panels
		Green Technology	Heat containment per data center cooling architecture
3	Panels	Front Door	Single perforated (minimum 63 % open)
		Rear Door	<ul style="list-style-type: none"> • Single or split solid when VEDs are used, or • Split, perforated where VEDs cannot be implemented
		Latches	Keyed lock upgradable to keyless system compression latch
		Top	<ul style="list-style-type: none"> • VEDs (heat containment) required in facilities equipped with overhead return air ducting systems • High-capacity cable access w/brushes
		Side	<ul style="list-style-type: none"> • Solid • Locking
		Bottom	<ul style="list-style-type: none"> • Solid • With high-capacity cable access w/ brush grommets or air dam foam in raised access floor locations
4	Required Accessories	Air Dam and Sealing Kit	Required under each cabinet and between rails and cabinet sides
		Castors	Required for safe cabinet movement
		Leveling Legs	Required
		Baying Kit	Required to keep cabinets aligned
		Grounding	<ul style="list-style-type: none"> • RBC • Bonded in accordance with ANSI/TIA-607-D Generic Telecommunications Bonding and Grounding (Earthing) for Customer Premises • Tagged with “Do Not Disconnect” See Section 4.2.9 for specific requirements and guidance
		rPDU brackets	Zero U vertical single mount brackets for SD cabinets Double mount brackets for HD cabinets



Evaluation Factors

- Dimensions
- VEDs/heat containment
- Available RUs
- Grounding equipment and bonding

Implementation Guidance

This Standard specifies green technology in the form of heat containment. This approach to thermal management does have corresponding data center design requirements and, therefore, should be selected based on the cooling architecture of the target data center.

Server cabinets with VEDs shall be specified and provided for deployment to computer rooms with overhead return air ducting systems installed. In facilities with these supply/return air separation systems, cabinets shall be specifically designed to match the needs of the engineered environmental control system. Where a provider wants to install a non-standard cabinet, re-racking of equipment into a standard cabinet is required.

Where required by VA Seismic Design Requirements (H-18-8), enclosures require seismic restraint by bracing, anchorage, or similar practice. Rear rails of server cabinets shall be set not less than 6 in. from the rear door(s) of the cabinet to allow space for rear-mounted angled patch/distribution equipment in the Equipment Distributor and to accommodate up to four vertical rPDUs in high density applications.

Active networking equipment shall not be installed in server cabinets. This includes fabric interconnects, fabric extenders, and other types of equipment (e.g., TOR switches) used for network distribution, even when part of a 'converged' system. Except for in authorized wall-mounted TEs, active networking equipment shall only reside in designated network racks and network cabinets (HDAs and MDAs in data centers), using structured cabling systems to distribute network services to IT equipment in server cabinets. White server cabinets are specified for reduced energy absorption and increased reflectivity for improved visibility. Black servers, switches, patch panels, blanking panels, and other equipment makes it difficult for technicians to work within a dark cabinet due to the low light levels.

Cabinet height of 7.5 ft maximum is required to leave room for structured cabling, power busbars, containment systems, fires suppression, etc. A larger cabinet does not provide an advantage because the limiting load factor is the power and heat rejection capability of the cooling systems, not rack space. A taller cabinet also makes the equipment difficult to access without a ladder.



4.4.15 Network Equipment Racks

Table 39: Network Equipment Racks

ID	Primary Attribute	Secondary Attribute	Specification
1	Dimensions	Height	7.5 ft maximum
		Width	24 in. nominal minimum
		Depth	30 in. minimum
		Rail Style (Front/Rear)	<ul style="list-style-type: none"> EIA threaded or Square punched
		Rack Units	44/45
2	Design	Style	Channel rack
		Static Capacity	2,000 lb minimum
		Cable Management	Built-in overhead waterfall and cable management strap attachment points
		Rail Marking	Present on front and rear rails graduated starting RU number one at the bottom-most position
		Color	White or existing match
3	Required Accessories	Grounding	<ul style="list-style-type: none"> Rack Bonding Busbar (RBB) Bonded in accordance with ANSI/TIA-607-D Generic Telecommunications Bonding and Grounding (Earthing) for Customer Premises Tagged with "Do Not Disconnect" See Section 4.2.9 for specific requirements and guidance
		rPDU	rPDU brackets
		Side Air Intake Scoops	Required for racks with side-to-side airflow equipment

Evaluation Factors

- Dimensions
- Cable management capacities
- Available accessories for horizontal and vertical cable management
- Grounding equipment and bonding
- Static capacity
- Locking front or rear doors
- Side air intake scoops



Implementation Guidance

Racks and network equipment cabinets shall be used for all networking gear to include the MDA and the HDA.

Racks are mandatory for use in TRs.

Two-post and four-post (open wall) racks are prohibited for use in VA telecommunications spaces. Replace all existing racks with specified network equipment (channel) racks or network cabinets (depending upon the application). This Standard specifies a deep channel open rack to accommodate the depth and weight of most data networking equipment while providing high capacities for horizontal cable and large diameter Cat 6A patch cords.

White racks are specified for reduced energy absorption and increased reflectivity for improved visibility. Black networking equipment, patch panels, blanking panels, and other equipment makes it difficult for technicians to work within a dark rack due to the low light levels.

Server cabinets shall not be used in place of network racks due to inherent cable management limitations. Specifically designed network cabinets greater than 30 in. wide may be used in place of network racks if the proper cable management accessories are installed.

Where required by VA Seismic Design Requirements (H-18-8), enclosures require seismic restraint by bracing, anchorage, or similar practice.



4.4.16 Network Equipment Cabinets

Table 40: Network Equipment Cabinet Standards

ID	Primary Attribute	Secondary Attribute	Specification
1	Dimensions	Height	7.5 ft maximum
		Width	<ul style="list-style-type: none"> • 30 in. minimum • 40 in. maximum and preferred
		Depth	48 in. nominal with all doors and accessories installed
		Rack Units	44/45
2	Design	Rails	<ul style="list-style-type: none"> • Square-punched (2 pair = front + rear) • Toolless adjustable
		Rack Marking	Present on front and rear rails graduated starting one RU from the bottom
		Static Capacity	2,500 lb minimum
		Color	White or existing match
		Bonding Connection	Doors and frame
		Green Technology	Heat containment per data center cooling architecture
3	Panels	Front Door	Single or double perforated (minimum 63 % open)
		Rear Door	<ul style="list-style-type: none"> • Split solid when VEDs are used, or • Split, perforated where VEDs cannot be implemented
		Latches	Keyed lock upgradable to keyless system compression latch
		Top	<ul style="list-style-type: none"> • VEDs (heat containment) required in facilities equipped with overhead return air ducting systems • High-capacity cable access w/brushes
		Side	<ul style="list-style-type: none"> • Solid with brush sealed cable openings to allow for horizontal distribution • Vertical cable management • Locking
		Bottom	<ul style="list-style-type: none"> • Solid • With high-capacity cable access w/ brush grommets or air dam foam in raised floor environments



ID	Primary Attribute	Secondary Attribute	Specification
4	Required Accessories	Air Dam and Sealing Kit	Required under each cabinet and between rails and cabinet sides
		Castors	Required for safe cabinet movement
		Leveling Legs	Required
		rPDU brackets	Zero U vertical single mount brackets
		Grounding	<ul style="list-style-type: none"> RBC bonded in accordance with ANSI/TIA-607-D Generic Telecommunications Bonding and Grounding (Earthing) for Customer Premises Tagged with "Do Not Disconnect" See Section 4.2.9 for specific requirements and guidance
	Baying Kits	Required to keep cabinets aligned	

Evaluation Factors

- Dimensions
- VEDs/heat containment
- Available RUs
- Grounding equipment and bonding

Implementation Guidance

This Standard specifies green technology in the form of heat containment. This approach to thermal management does have corresponding data center design requirements and, therefore, should be selected based on the cooling architecture of the target data center.

Network equipment cabinets with VEDs shall be specified and provided for deployment to computer rooms with overhead return air ducting systems installed. In facilities with these supply/return air separation systems, cabinets shall be specifically designed to match the needs of the engineered environmental control system. Where a provider wants to install a non-standard cabinet, re-racking of equipment into a standard cabinet is required.

Where required by VA Seismic Design Requirements (H-18-8), enclosures require seismic restraint by bracing, anchorage, or similar practice.

White network cabinets are specified for reduced energy absorption and increased reflectivity for improved visibility. Black networking equipment, patch panels, blanking panels, and other equipment makes it difficult for technicians to work within a dark network cabinet due to the low light levels.

Cabinet height of 7.5 ft maximum is required to leave room for structured cabling, power busbars, containment systems, fires suppression, etc. A taller cabinet does not provide an advantage because the limiting load factor is the power and heat rejection capability of the



cooling systems, not rack space. A taller cabinet also makes the equipment difficult to access without a ladder.

4.4.17 Telecommunications Enclosure Layout Standards

Telecommunications Enclosures (TE) are permitted for use in non-clinical spaces in lieu of standard TRs when meeting the established criteria. They are not permitted in clinical spaces.

Table 43: Telecommunications Enclosure Layout Standards

ID	Primary Attribute	Secondary Attribute	Specification
1	Cabinet	Construction	<ul style="list-style-type: none"> NEMA-12 or equivalent Tempered glass front door Dust seals and replaceable inlet/outlet vents/airflow openings/fans
		Access	<ul style="list-style-type: none"> Cabinet swings open to access rear of installed equipment Swinging front door to access front of installed equipment Both sections able to be physically locked
		Racking Rails	EIA-310-D 19 in. front and rear adjustable
		Height	<ul style="list-style-type: none"> 12 RU (horizontal distribution only) 26 RU (main distribution area function only)
		Width	24 in. minimum
		Mounting	16 in. on-center for standard stud construction
2	Outfitting of TEs	Input Power	A/B redundant L5-30 120 V 20 A circuits
		UPS	<ul style="list-style-type: none"> Rack-mounted 2880 VA metered L5-30 input/output Dual/delta conversion not required Connected to A-side input power circuit
		Rack Power Distribution	<ul style="list-style-type: none"> A/B redundant 1 RU horizontal rPDUs L5-30 input; minimum eight 5-15R outlets
		Heat dissipation	120 V fans
		Fiber Backbone	<ul style="list-style-type: none"> 1 RU fiber distribution cabinet Flat cabinet authorized



ID	Primary Attribute	Secondary Attribute	Specification
		Horizontal Distribution	<ul style="list-style-type: none"> • 1 RU UTP patch panels • Flat patch panels authorized • Maximum one patch panel for 12 RU TE; two patch panels for 26 RU TE
		Network Switches	<ul style="list-style-type: none"> • Standard 1 RU 48-port network switches • Maximum one switch for 12 RU TE; two switches for 26 RUTE
		IT Equipment Power Cord Type	<ul style="list-style-type: none"> • 120 V 15 A • C13 at IT equipment power supply and NEMA 5-15 at rPDU
		IT Equipment Power Cord Color Code	<ul style="list-style-type: none"> • A-side: Black • B-side: A distinctly different color (white or gray preferred) • Differentiated by source bus (jacket or other marking) • Comply with any established local color schema
		Bonding	Standard equipment and interconnections as per a TR and network channel rack

Evaluation Factors

- Installation environment
- Rack Unit count required for horizontal distribution
- Number of WAO served
 - Network switch count requirement
 - Patch panel count requirement
- Access locks for both front and rear access
- Grounding equipment and bonding

Implementation Guidance

A maximum of 96 WAOs can be supported by a standardized TE. Each data jack in a workspace telecommunications outlet, wired back to the patch panels in the TE, is considered a WAO for these purposes.

- Where 1-48 WAOs are planned, a 12 RU (half-height) standardized TE is used
- Where 49-96 WAOs are planned, a 26 RU (full height) standardized TE is used

No services other than VA LAN horizontal distribution can be supported from a standardized TE, except in a building with no VA staffing presence and no requirements for VA LAN but where guest WiFi is provided.



TEs may be deployed to spaces falling within the environmental envelope conditions for a TR, as described in Figure 19 and Figure 24 of the ISTS. Ambient air conditions in the space are between 41 °F - 95 °F dry bulb, 8 % - 80 % RH, and a dew point less than 82.4 °F. In healthcare facilities, the more restrictive requirements of the [HVAC Design Manual](#) must be met.

Non-standard environmentally conditioned TEs may be approved by variance for use in spaces where the ambient air conditions extend outside of these limits.

All knockouts and cable entry points shall be sealed to prevent liquid and dust entry.

Accessories include cable port brush kit, low-noise dual fan and filter kit, replacement filter kit, shelves, vertical rail-mounted cable managers, and LED light kit.

Non-diverse pathways for backbone media may be served by a single TE, but the pathway must still contain redundant fiber backbone media (both A/B backbone elements present).

Criteria requirements for diverse path backbone:

- Supports VA clinical staff function in a healthcare setting
- Supports VA clinical-supporting staff function with end-user desktop and/or VOIP phone requirement
- Supports VA administrative staff function with end-user desktop and/or VOIP phone requirement (reduced fiber count routing may be considered if space cannot be used for a healthcare/clinical function, e.g., Washington DC administrative buildings, VBA regional office buildings)
- Not required for patient-only areas without any VA staffing function presence (non-diverse and reduced fiber count routing may be considered)
- Not required for VA technician, maintenance, or trades areas or facilities (non-diverse and reduced fiber count routing may be considered)



5 Administration Standards

These specifications are intended to allow complete and consistent identification and physical location information for VA data center and computing facilities, physical plant and distribution equipment supporting VA data center facilities, equipment located within the VA data center environment, and the component types and elements described for use in physical and logical information management systems describing the connectivity of physical elements present in the data center environment.

Identification specifications are based on the current version of ANSI/TIA-606-C, with modifications for the VA operating environment.

5.1 Data Center Position Identification

The purpose of this specification is to establish guidance for identifying physical locations for equipment and components in the VA data center environment. This specification contains instruction for uniform identification of equipment and component locations used at telecommunications spaces across the enterprise.

Specifically, because of the legacy nature of VA facilities, no single facility location system is implemented enterprise-wide. Individual VA locations (i.e., VAMCs) have developed and implemented individual location identification methodologies that are beyond the scope of this document. Telecommunications spaces within VA facilities shall follow the location identification guidance herein.

Table 41: Data center Position Identification Conventions

ID	Primary Attribute	Secondary Attribute	Specification
1	Data Center Floor Grid Location Identification	Alignment	Aligned with plan North in building drawings
		Location Origin	Northwest corner
		Location Increments	<ul style="list-style-type: none"> • Two-foot increments with alphanumeric identification • Begin at the appropriate designator such as A1 for first full floor tile, depending on number of tiles in the data center • Increase letters from left to right • Increase numbers from top to bottom
		Variance/Waivers	Required but granted automatically if existing (legacy) system is compatible



Evaluation Factors

Each data center uses a compliant grid identification scheme allowing detailed location identification of physical equipment.

Implementation Guidance

Data center layouts shall be master-planned. Equipment layouts can be adequately defined by location in the data center master floor plan. This location identification scheme shall be applicable to all enterprise data centers, existing and new. Individual facilities shall apply for a variance if there is an existing location schema differing from the one stated. Variance for compatible legacy systems will be approved automatically in the DCIM system of record for facilities with an approved variance. A characteristic watermark or similar shall be assigned to the plan view to indicate a non-standard layout.

While some buildings are built to align with true north, many are not – but the architectural plans for all facilities will have a “Plan North,” aligned with the top of the drawing. This specification assumes that data center access floor grids will align with Plan North.

The ANSI/TIA-606-C standard initiates the computer room location system at the top left (plan NW) corner of the computing floor space. The access floor grid (where used) shall be alphanumeric with tile location A1 (*depending on data center size; see below*) denoting the (plan) northwestern-most full tile on the floor. For grid location identification purposes, beginning with alphanumeric tile location A01, letters shall increase across the X-axis (left to right) from A to Z, or from AA to AZ, then BA to BZ, and so on. Numbers shall increase down the Y-axis (top to bottom) from 1, or 01, onward (spreadsheet orientation). Representative examples of grid identification are shown below for reference.

If a facility has more than 26 tiles on the X-axis, use AA as the starting location (rather than A) to allow sorting in database tools. For example, AA through AZ, then BA through BZ – do not start with A through Z in these larger facilities. If the data center has:

- Fewer than 10 tiles on the Y-axis, then use “A1-A9.”
- 10 or more tiles on the Y-axis, then use “A01-A99.”
- 100 or more tiles on the Y-axis, then use “A001-A999.”
- The same follows for the X-axis where “A1-Z1” are used for 26 tiles or fewer in the Y-direction, and “AA01-ZZ01” are used for data centers with over 26 tiles in the Y-direction.

Where an irregular arrangement of the facility means that there is no tile in what would typically be the A1 position, label floor tiles from this location using 2-foot increments. This system is of use in designating equipment locations for non-standard raised floor items, including CRAC units and larger storage or mainframe units. Note that there may be partial tiles around the first full tile(s) in any row or column that are not numbered in this system.

In data centers operated without an access floor grid, apply stenciled grid crosshairs at 24-inch centers to the floor (where the crosshair locations are accessible). The crosshairs should extend in each cardinal direction at least 4 in. and 4 in. on each axis). Note that the grid need not begin in the physical corner of the room and may be moved a simulated ‘partial tile’ in to better align with installed equipment.



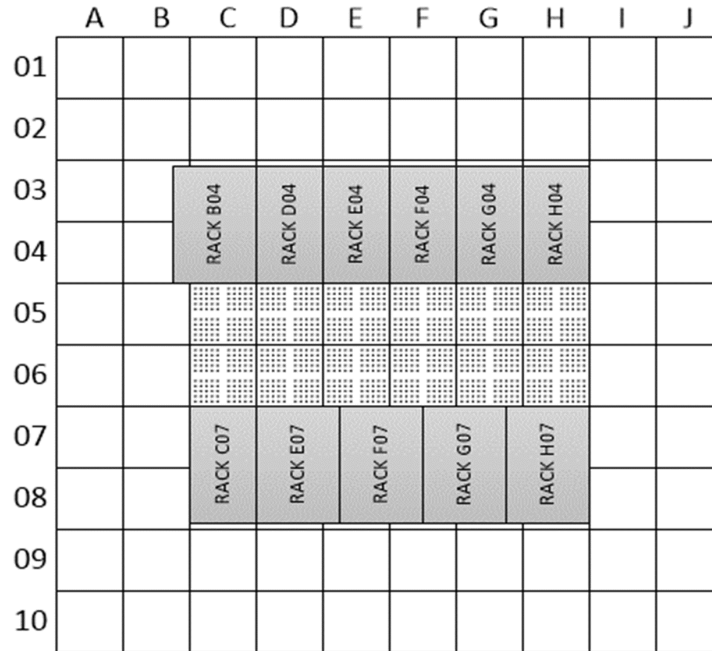

Grid Identification — Typical Small Computer Room

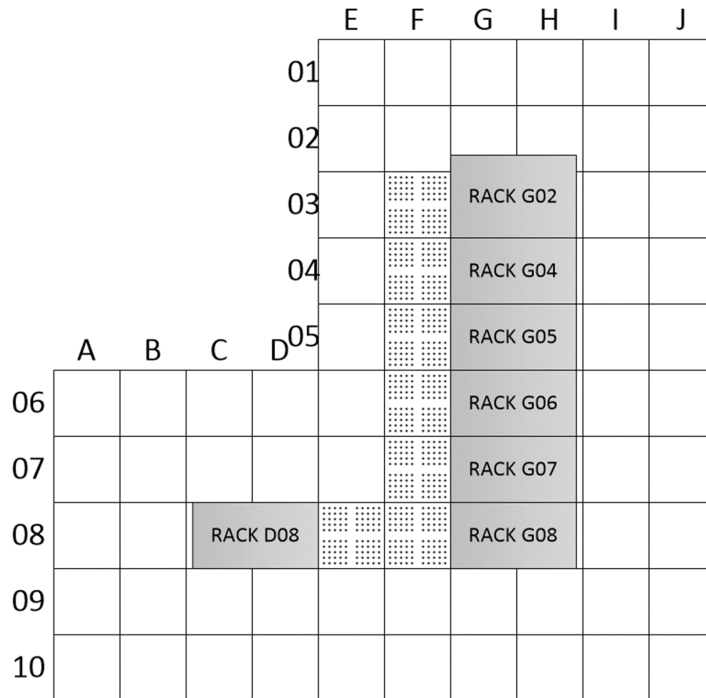

Grid Identification — Offset Start Computer Room

Figure 26: Typical Position Identification Examples



Identification of individual computer spaces within a single building depends upon the configuration of those spaces. Where access floor spaces are adjacent and use the same grid (i.e., rooms separated by partition walls for security or other isolation purposes), both spaces shall use the same grid beginning with the A01 tile in the northwestern-most space. Where access floor spaces are separated and/or are based on separate grids (i.e., one room in one portion of a building and the other in a different portion), each space shall use individual grids, each starting with its own A01 tile.

Grid identification within each data center space shall be posted to allow occupants to understand their current location. Post location identifiers on walls, columns, and/or from hanging tags as necessary to allow occupants to reasonably determine all grid locations. Identifiers shall be a minimum of 4-inch high characters, semi-gloss black lettering, with top of character not more than 6 inches below ceiling, concrete slab, truss line or typically accepted physical divider between workspace and ceiling line.

Items on the floor shall be noted as being located at locations in accordance with ANSI/TIA-606-C, meaning the grid location of the tile containing the left front corner of the item (when facing the front of the item). If the item has no identifiable front, the first full tile covered closest to the grid origin shall be the location identifier.

5.1.1 Cross-Reference to Other Identification Systems

Nothing in the DCIM specification is designed or intended to conflict with any other mandatory standard(s) affecting the VA data center environment.

VA information management tools such as DCIM, BAS, and Computerized Maintenance Management Systems (CMMS) shall include database fields (where applicable) to identify the standardized location identifier (and other location identifiers) as specified herein. These fields are not intended to supplant or replace other identification numbers already in use by other systems.

5.1.2 Standardized Data Center Facility Type Identification

Data centers across VA generally support the local mission and are tailored to the mission of the local office. This leads to multiple types of (and names for) the facilities, which must be standardized to ensure that the intent of using a facility's name is clearly understood.

The list of FACILITYTYPE attributes is intended to align with (but will not be replaced by) the data center classification schema described in Section 2 as VA undergoes further transformation and data center consolidation activities.

Evaluation Factors

- Each data center is classified as a single FACILITYTYPE.
- All data centers are classified as a FACILITYTYPE on the current FACILITYTYPE list.
- Use of FACILITYTYPE is consistent in OIT-standardized data structures.



Implementation Guidance

The FACILITYTYPE attribute describes at a high-level what type of facility the data center supports, the specific mission of the facility, or what type of information is processed by the data center.

The FACILITYTYPE list is maintained by NDCOL and is anticipated to be simplified as the enterprise completes transformative data center consolidation activities.

Classify all data center facilities as exactly one of the facility types in the list below. Computer room facilities in VAMCs, whether OIT, CE, facility management service, R&D, or otherwise, are classified as VAMCs in the FACILITYTYPE list.

FACILITYTYPE names shall only consist of three or four alpha characters and not contain ampersands, numbers, or other special characters to prevent issues with DCIM systems or other database queries.

Table 42: Standard FACILITYTYPE Naming Conventions – Campus Support Centers (CSC)*

FACILITYTYPE	Description
VAMC	VA Medical Center
OPC	Large Outpatient Clinics
CBOC	Large Community-Based Outpatient Clinics
HCC	Health Care Center

* There are some specific instances of overlap between CDCs and VAMC facilities (e.g., Cleveland, Temple) as the data centers in these locations operate both as CSCs and also provide or are designed and built to meet the intent of operation as a CDCs.

Table 43: Standard FACILITYTYPE Naming Conventions - Mission Support Centers (MSC)

FACILITYTYPE	Description
CMOP	Consolidated Mail Outpatient Pharmacy
CPAC	Consolidated Patient Account Center
OIFO	Office of Information Field Office
HEC	Health Eligibility Center
NCPS	National Center for Patient Safety



FACILITYTYPE	Description
PBM	Pharmacy Benefits Management Office
ALC	Acquisition Logistics Center
CSP	Cooperative Studies Program
HSRD	Health Services Research & Development Center

Table 44: Standard FACILITYTYPE Naming Conventions - Network Support Centers (NSC)

FACILITYTYPE	Description
NSC	Network Support Center (generic if no other designation is appropriate)
CBOC	Typical size Community-Based Outpatient Clinics (CBOC)
VARO	VBA Regional Office
VRE	Vocational Rehabilitation & Employment Center
RMC	Records Management Center

5.1.3 Standardized Data Center Naming Convention

Facility legacy and common names are not standardized and do not yield sufficient clarity on where an OIT-operated or OIT-supported computer or telecom space is located, what its function is, or what the intended mission supported by the facility or space is, in the context of VA's data center strategy.

Evaluation Factors

- Each data center is assigned a single standardized data center name.
- Use of CITYNAME is consistent in OIT-standardized data structures for all data center facilities.
- Use of FACILITYTYPE is consistent in OIT-standardized data structures for all data center facilities.

Implementation Guidance

The basic Standardized Data Center Name is formatted as [CITYNAME FACILITYTYPE]. The master naming list for Standardized Data Center Names shall be maintained by NDCOL.



The CITYNAME attribute is intended to be the physical municipality in which the site or facility is primarily located which is unique from other municipality names in use and is the most discrete and descriptive. This field is qualitative depending on the mission and function of the type of VA facility; for example, the new VAMC supporting the Denver, CO metropolitan area is actually located in Aurora, CO, but the CITYNAME will be Denver.

Although the VAMC supporting Augusta, ME, is located in Togus, ME; because Augusta, GA is the more commonly known metropolitan area, the Georgia facility will be assigned CITYNAME Augusta, while the Maine facility will be assigned CITYNAME Togus.

The FACILITYTYPE attribute describes at a high-level what type of facility the data center supports, the specific mission of the facility, or what type of information is processed by the data center. The available types align with the data center classification archetypes. As classes of facilities are simplified and collapsed through data center consolidation efforts, this list may be revised.

A site or facility will be referred to by its “standard name” where possible. Where there is more than one reportable computer room at a single site or facility, both computer rooms share the same “standard name” and are differentiated using its OMB assigned DCOI facility ID number. This naming convention includes the ability to identify all OIT computer support spaces (computer rooms, TRs, non-OIT computer rooms, and similar) uniquely, drilling down from the site or facility ‘standard name’ with additional record fields as described. Due to the wide variety of legacy configurations at individual facilities, additional detailed guidance on how to linguistically identify these individual spaces is not provided.

Example: The fictional VAMC in MyTown is classified as a Campus Support Center for the hospital campus; its standardized data center name is MyTown CSC. There are other IT support spaces on the campus supported by this CSC, including a biomed server room that is determined to not be able to be consolidated to the main data center, two main TRs servicing remote buildings on campus, auxiliary TRs servicing other floors in the remote buildings, and auxiliary TRs servicing different wings and floors of the main hospital building. All these spaces are considered hierarchically under (attached to) the MyTown CSC. They are specifically identified by building number and room number; for example, MyTown CSC, Bldg 3, Rm 3-102.

Not all computing support spaces will be assigned a Standardized Data Center Name. All computing support spaces, from computer rooms to TRs to non-reportable rooms containing IT equipment that requires IT or physical environment management, shall be assigned a VA Record ID number, separate from the DCOI-assigned facility ID number. The VA Record ID numbers shall be of the format “VA-YYYYY,” where YYYYY is a unique five-digit number. VA Record ID numbers are not intended to be sequential, either at time of assignment or in the future. ID numbers are assigned at the enterprise data warehouse level by NDCOL and distributed by the NDCOL DCIM team.



Example: MyTown CSC is assigned DCOI facility ID number DCOI-99999. The VA Record ID number for the reportable data center is VA-12345, and the TRs supporting two-story remote building 3 are VA-34201 and VA-58456. The TRs, -34201 and -58456, are supported by the reportable data center but are not assigned a DCOI facility ID number.

Example: A fictional National Cemetery has a computing support space, operating a router connecting the facility with the VA wide area network. NCA spaces do not operate data centers. This facility will not be assigned a Standardized Data Center Name or DCOI facility ID number but will be assigned a VA Record ID number, VA-56789.

Where a computing support space is directly supported by a data center with a DCOI facility ID number, include record field information that the space is supported by that data center, indicating the hierarchical arrangement. Not all computing support spaces are located in facilities with a data center, or directly supported by a facility subject to the standardized naming convention. Assign these spaces a VA Record ID number; they will be further identified by their physical address and having blank record field information where the standard name and DCOI facility ID number of the supporting facility would otherwise be recorded.

The legacy (or official) site or facility name shall be retained and record fields available in all databases and systems to cross-reference the standardized name with the legacy name. An example of a legacy name that may not be sufficiently descriptive is “John J Pershing VAMC.” Without additional information, the location of this facility could be in doubt.

5.2 Information Transport Systems Equipment and Component Labeling

The purpose of this specification is to establish guidance for labeling physical locations, equipment, and components in the VA data center environment congruent with the identification specifications in this Standard.

This specification contains instruction for uniform and appropriate labeling of data center and ITS equipment at VA data center facilities. Applications include:

- Identifying and labeling new systems when installed
- Re-labeling existing systems as field verification documentation is generated
- Uniform labeling of equipment and components used at data processing facilities across the enterprise

5.2.1 Label Materials

Materials for labeling purposes are not specifically defined in this Standard. Use materials appropriate to the purpose, intent, environment, and equipment being labeled.



5.2.1.1 Approved Materials

Labels should be resistant to the environmental conditions at the point of installation (such as moisture, heat, or ultraviolet light), and should have a design life equal to or greater than that of the labeled component.

5.2.1.2 Unapproved Materials

Materials which can be lost, damaged, rendered unreadable, easily removed, soiled or degraded by operating environment, or which are of a non-permanent nature shall not be used for labeling or identification purposes. This includes (but is not limited to) paper, paper in clear plastic protectors, and direct labeling of equipment and components with markers or paint.

Table 45: Information Technology Systems Equipment and Component Labeling Conventions

ID	Primary Attribute	Secondary Attribute	Specification
1	Equipment Labeling	Attachment	Permanent
		Position	<ul style="list-style-type: none"> • Readily visible • Horizontal orientation where feasible • Top right corner of equipment faceplate where feasible • Shall not interfere with operation of labeled equipment
		Materials	<ul style="list-style-type: none"> • Appropriate for the installation environment • Durable and permanent • Heat resistant in high-temperature areas
		Coloration	Not specified
2	IT Equipment Rack/Cabinet Labeling	Governing Industry Standard	ANSI/TIA-606-C, NFPA 70
3	Data Communications Cabling Labeling	Labeling Requirements	Floor Grid Location
		Label Location	Top right front door, top right back door, top right front inside cabinet, top right back inside cabinet
		Governing Industry Standard	ANSI/TIA-606-C
		Label Location	Both ends of all installed cables and cords
		Coloration	Following local site schema



ID	Primary Attribute	Secondary Attribute	Specification
4	Power Distribution Labeling	Governing Industry Standard	ANSI/TIA-606-C, NFPA 70
		Label Location	<ul style="list-style-type: none"> Both ends of all installed cords Within 36 in. of leaving distribution panel enclosure Within 12 in. of the point-of-use end of conduit
		Coloration	<ul style="list-style-type: none"> No enterprise specification is prescribed Colors shall be used to differentiate electrical bus power sources

Evaluation Factors

- All equipment and components are labeled as specified
- Labeling is done in a legible, professional manner
- Facility location systems are in place in the data center environment
- Power distribution is labeled appropriately from end-to-end and uses bus color scheme allowing rapid visual identification

Implementation Guidance

Data center equipment and components shall be labeled per operational requirements before being designated operable or in service.

- Labels shall be permanently attached and designed to withstand wear, erosion, and corrosion.
- Position labels so they are readily visible and, where feasible, oriented in a horizontal position. Where feasible, labels should be placed near the top right corner of permanently installed equipment faceplates. Labels shall be legible without manipulation by site personnel. Although not recommended, vertical orientation may be used only where space is limited. Vertical orientation shall be read from top to bottom.
- Labels or tags installed under this specification shall not interfere or alter existing manufacturer's nameplate or code information. Labels described in this specification are intended for identification within the local facility and are not expected to support or substitute for asset management labeling.
- Labels shall be located to eliminate any possible confusion as to the item being identified and shall not obscure other items nearby.
- Labels shall not interfere with an operator's ability to read the instrument, display, or gauge, or to operate the equipment.
- Labels shall be mounted in such a way as to preclude accidental removal.
- Labels shall be mounted on a flat surface, if possible.
- Use ANSI/TIA-607-D identifier scheme for telecommunications bonding and grounding system elements.



- Use compatible terms in ISO/IEC 30129 for all new construction or renovation.

For existing infrastructure, labels using legacy terms from earlier revisions of ANSI/TIA-607-D are exempted until routine tech refresh, lifecycle replacement, upgrades, new installations, or renovations of existing space.

5.2.2 Support Infrastructure Identification

This section identifies equipment support elements covered under this Standard. Equipment support elements are passive components such as racks and cabinets that serve to house or mount both passive and active components such as patch panels or servers.

Table 46: Support Infrastructure Identification Conventions

ID	Primary Attribute	Secondary Attribute	Specification
1	Equipment Support	Row	Label: ROW-xxx ROW designates row xxx is a sequential number (pad number of digits in designator (x, xx, xxx) to match the total number) Example: Row 01
		Rack/Cabinet (Final)	Label: RK-aann <ul style="list-style-type: none"> • RK designates rack (or cabinet) labeled left to right when looking at the front of the rack • aa is the alphabetic portion of the floor grid location (pad number of digits in designator (a, aa) to align with the number of floor location tiles in the plan E-W axis) • nn is the numeric portion of the floor grid location (pad number of digits in designator (n, nn, nnn) to match the total number) Example: RK-AM45
		Rack/Cabinet (Design Phase Only)	Label: RK-nnxxx <ul style="list-style-type: none"> • RK designates rack (or cabinet) labeled left to right when looking at the front of the rack • n is the numeric row designator (pad number of digits in designator (n, nn) to match the total number of rows) • xxx is a sequential number (pad number of digits in designator (x, xx, xxx) to match the total number) Example: RK-101 <i>Note: These will be converted to alphanumeric locations upon physical installation for sustainment.</i>



ID	Primary Attribute	Secondary Attribute	Specification
		Pathway Rack (Final)	<p>Label: PRK-aann</p> <ul style="list-style-type: none"> • PRK designates pathway rack, which is a small enclosure (typically five RU) that is generally attached to an overhead cable tray assembly above an IT equipment rack or cabinet for the purposes of terminating structured cabling to a patch panel in the pathway rack • aa is the alphabetic portion of the floor grid location (pad number of digits in designator (a, aa) to align with the number of floor location tiles in the plan E-W axis) • nn is the numeric portion of the floor grid location (pad number of digits in designator (n, nn, nnn) to match the total number) <p>Example: PRK-AM45</p>
		Pathway Rack (Design Phase Only)	<p>Label: PRK-nnxxx</p> <ul style="list-style-type: none"> • PRK designates pathway rack, which is a small enclosure (typically five RU) that is generally attached to an overhead cable tray assembly above an IT equipment rack or cabinet for the purposes of terminating structured cabling to a patch panel in the pathway rack • n is the numeric row designator (pad number of digits in designator (n, nn) to match the total number of rows) • xxx is a sequential number (pad number of digits in designator (x, xx, xxx) to match the total number) <p>Example: PRK-101</p> <p><i>Note: These will be converted to alphanumeric locations upon physical installation for sustainment.</i></p>
		Rack Unit	<p>Label: ru</p> <ul style="list-style-type: none"> • ru is the RU number present (stamped or painted) on front and rear rails corresponding to the bottom left corner of the item in the rack or server <p>Example: SERVER AD02-35 with 35 indicating the RU.</p>
2	Cable Tray	Not Defined	Not Defined



ID	Primary Attribute	Secondary Attribute	Specification
3	Cable Management Panels	Horizontal	Label: CMH-aann-ru <ul style="list-style-type: none"> • CMH designates cable management panel • aann designates installed location by rack or cabinet identifier • ru is the RU in which the panel is installed Example: CMH-AM45-30 (cable management panel at position RU30 in rack or cabinet AM45)
		Vertical	Label: CMV-aann-aann; CMV-aann-L; CMV-aann-R <ul style="list-style-type: none"> • CMV designates cable management panel • aann-aann designates rack or cabinet identifiers, left-to-right, viewed from front, between which panel is installed • L or R designates on which side of rack panel is installed, as viewed from front of rack, if not installed between racks Example: CMV-AM45-AM46 (cable management panel is between racks or cabinets AM45 and AM46)

5.2.2.1 IT Equipment Cabinet/Rack Location Identification

Use the modified ANSI/TIA-606-C compatible labeling format with cabinet/rack grid location and cabinet/rack RU position (format xy-ru) to identify IT equipment, switch, patch panel, and similar equipment locations. Equipment location in IT equipment racks shall be identified by the bottom RU that the equipment occupies (e.g., a four-RU height server position occupying positions 36-39 is located at RU position 36). VA-standard IT equipment racks have 44 or 45 RU of spaces for racked equipment. RU numbering shall begin at the bottom-most mounting space and increase upwards (one RU is 1.75 in. in height, and the numbering is typically printed on the mounting rails).



In the example shown in Figure 27 below, the server in IT equipment rack AD02 that occupies spaces 27 and 28 RU from the bottom of the rack would be identified with location AD02-27.

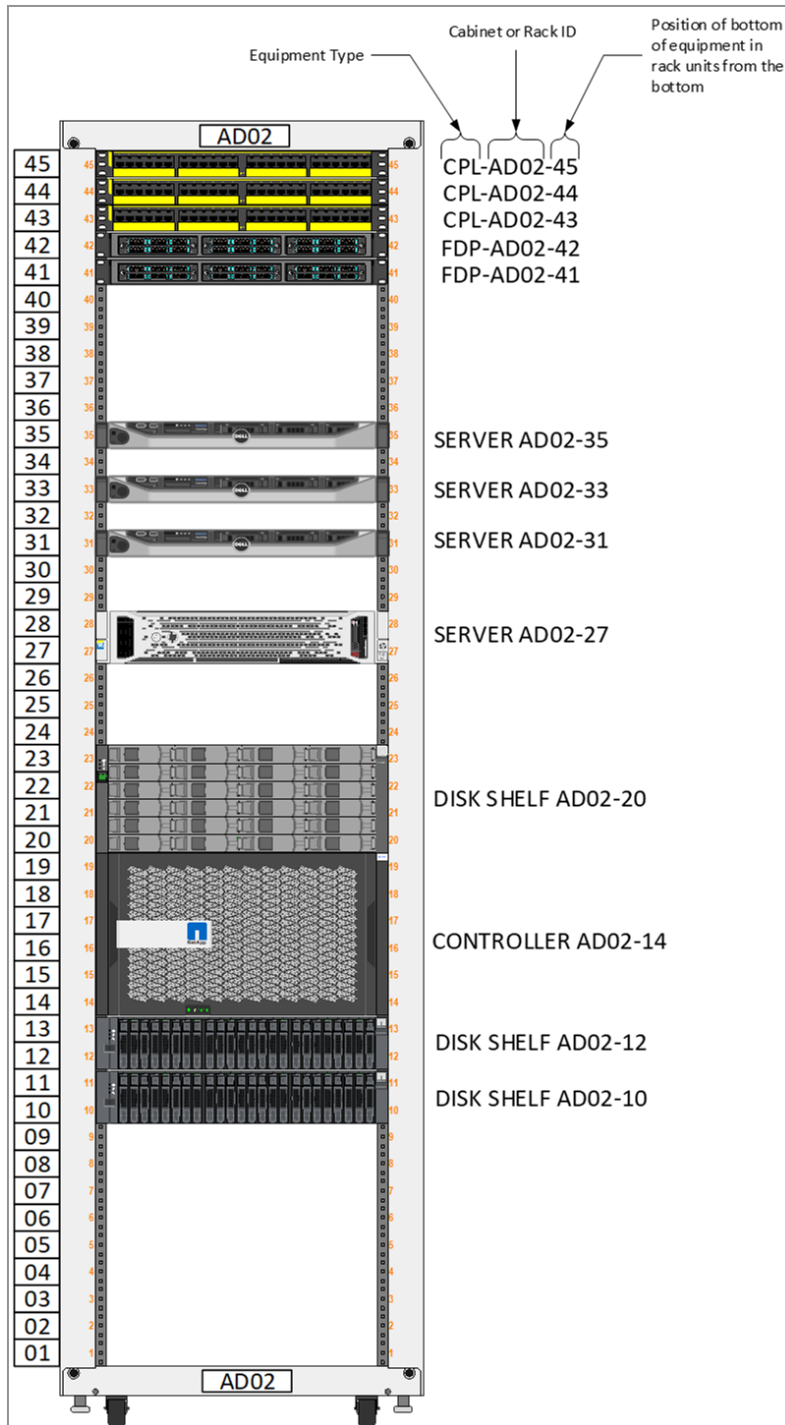

Figure 27: Rack Unit Identification Example



5.2.3 Transport Media and Interface Identification

This section identifies transport media and associated elements covered under this Standard. Transport media includes, but may not be limited to, all horizontal and vertical (backbone) cabling and patch cords. Associated elements include, but may not be limited to, patch panels and fiber termination elements.

Table 47: Transport Media and Interface Identification Conventions

ID	Primary Attribute	Secondary Attribute	Specification
1	Patch Panel	UTP	Label: CPL-aann-ru <ul style="list-style-type: none"> • CPL designates UTP patch panel • aann designates installed location by rack or cabinet identifier • ru is the RU in which installed Example: CPL-AM45-40 (patch panel installed in RU40 in rack, cabinet, or pathway rack AM45) <i>Note: aann-ru may be utilized as the sole label designator (without CPL). The fully qualified name is intended to support reporting activities through a physical layer asset management system.</i>
		UTP Patch Panel Position	Label: CPL-aann-ru.xx <ul style="list-style-type: none"> • CPL designates UTP patch panel • aann designates installed location by rack or cabinet identifier • ru is the RU the panel is installed • xx is the position number as identified by the patch panel stamped label Example: CPL-AM45-AA.24 (position 24 in the patch panel designated as AA in rack, cabinet, or pathway rack AM45) <i>Note: aann-ru.xx may be utilized as the sole label designator. The fully qualified name is intended to support reporting activities through a physical layer asset management system.</i>
2	Fiber Distribution Termination Hardware	Fiber Distribution Panel/Cabinets	Label: FPL-aann-ru <ul style="list-style-type: none"> • FPL designates fiber distribution panel • aann designates installed location by rack or cabinet identifier • ru is the RU the distribution panel is installed Example: FPL-AM45-30 (fiber cabinet at position RU30 in rack or cabinet AM45)



ID	Primary Attribute	Secondary Attribute	Specification
		Fiber Distribution Cassette	<p>Label: FCS-aann-ru.L</p> <ul style="list-style-type: none"> • FCS designates fiber distribution panel cassette • aann designates installed location by rack or cabinet identifier • ru is the RU in which the FCS is installed. • L designates the fiber distribution cabinet/panel slot location ID numbered from left to right starting at 1 <p>Example: FCS-AM45-40.2 (the cassette in slot location two of FCS in RU40 in rack or cabinet AM45)</p>
		Fiber Distribution Cassette Interface Position	<p>Label: FCS-aann-ru.L.xx</p> <ul style="list-style-type: none"> • FCS designates fiber distribution cassette interface position • aann designates installed location by rack or cabinet identifier • ru is the RU in which the FDC is installed • L designates the fiber distribution cabinet/panel slot ID • xx is the position identifier as labeled on the cassette. If a label is not available, then use (L) for the left MPO and (R) for the right MPO <p>Example: FCS-AM45-40.2.05 (position five in the cassette in slot two of FCS installed in RU40 in rack or cabinet AM45), alternately FCS-101-40.2.L</p>
3	Cable (Data Communications)	Bulk Unshielded Twisted Pair (UTP)	<p>Label: UTP[aann-ru.yy]/[aann-ru.yy]</p> <ul style="list-style-type: none"> • UTP designates unshielded twisted pair • aann designates terminal locations by rack or cabinet identifier • ru is the patch panel RU designator • yy is a two-digit number corresponding to the patch panel position <p>Example: UTP[AM45-42.24]/[AAR15-03.24] UTP connecting position 24 in patch panel located at RU42 in rack AM45 to position 24 in patch panel located at RU03 in pathway rack AR15</p>



ID	Primary Attribute	Secondary Attribute	Specification
		Pre-terminated Cable Assemblies (UTP)	<p>Label: UTP[aann-ru]/[aann-ru].nn-mm</p> <ul style="list-style-type: none"> • UTP designates unshielded twisted pair • aann designates terminal locations by rack or cabinet identifier • ru designates RU in which installed • nn-mm are two numbers that identify the start and end ports to be connected by the bundle <p>Example: UTP[AM45-AA]/[AR15-AB].01-06 UTP bundle connecting patch panel AA located in rack AM45 to patch panel AB in rack AR15 port 01 to port 06 (inclusive)</p>
4	Fiber Cable (Data Communications)	Pre-terminated Cable Assemblies (Multi-mode)	<p>Label: FMM[aann-yy.L]/[aann-yy.L]</p> <ul style="list-style-type: none"> • FMM designates fiber optic cabling, multimode • aann designates terminal locations by rack or cabinet identifier • yy is a numeric fiber distribution cabinet/panel identifier per rack or cabinet • L designates the fiber distribution cabinet/panel cassette or slot ID and the left or right MPO connector <p>Example: FMM[AM45-03.2L]/[AR15-03.2L] Multi-mode cable assembly connecting cassette two, left MPO in FCS 03 located in rack AM45 to cassette two, left MPO in FCS 03 located in rack AR15</p>
		Pre-terminated Cable Assemblies (Single-mode)	<p>Label: FSM[aann-yy.L]/[aann-yy.L]</p> <ul style="list-style-type: none"> • FSM designates fiber optic cabling, single mode • aann designates terminal locations by rack or cabinet identifier • yy is a numeric fiber distribution cabinet/panel identifier per rack or cabinet • L designates the fiber distribution cabinet/panel cassette or slot ID and the left or right MPO connector <p>Example: FSM[AM45-03.2R]/[AR15-03.2R] Multi-mode cable assembly one connecting cassette two, right MPO in FCS 03 located in rack AM45 to cassette two, right MPO in FCS 03 located in rack AR15</p>



ID	Primary Attribute	Secondary Attribute	Specification
5	Patch Cords	UTP	<p>Label: CCA[aann-ru.xx]/[aann-ru.xx]</p> <ul style="list-style-type: none"> • CCA designates UTP patch cord • aann designates terminal locations by rack or cabinet identifier • ru is the RU location of the patch panel or device • xx is the port or visually identifiable network interface card ID to which the end of the patch cord is connected <p>Example: CCA[AM45-44.12]/[AR15-30.2] UTP patch cord connecting patch panel 44 position 12, located in rackAM45 to IT equipment port 2, located in RU position 30, rack AR15</p>
		Modular Plug Terminated Link (MPTL) for security cameras, WAPs, and other PoE equipment	<p>Label: CCA[aann-ru.xx]/[CAMxxx] or [WAPxxx] or [aann-RPDU.s(.x)]</p> <ul style="list-style-type: none"> • CCA designates UTP patch cord • aann designates terminal locations by rack or cabinet identifier • ru is the RU location of the patch panel or device • xx is the port or visually identifiable network interface card ID to which the end of the patch cord is connected • CAM designates camera (by local site camera naming convention) • WAP designates wireless access point (by local site WAP naming convention) • RPDU designates RPDU. For RPDUs, the .s is either A or B indicating the side, and the (.x) is either 1 or 2, only used for HD cabinets <p>Example: CCA[AM45-44.12]/[AR15-CAM118] UTP patch cord connecting patch panel 44 position 12, located in rackAM45 to IT camera 118</p>



ID	Primary Attribute	Secondary Attribute	Specification
		Fiber Optic	<p>Label: FCA[aann-ru.xx]/[aann-ru.xx]</p> <ul style="list-style-type: none"> • FCA designates fiber patch cord • aann designates terminal locations by rack or cabinet identifier • ru is the RU location of the patch panel or device • L designates the fiber distribution cabinet/panel slot location ID numbered from left to right starting at 1, then from top to bottom (see explanatory diagram in implementation guidance below) • xx is the port or visually identifiable network interface card ID to which the end of the patch cord is connected <p>Example: FCA[AM45-44.2.06]/[AM45-24.2] Fiber patch cord connecting patch panel in RU44, cassette in slot 2, port 06, located in rack AM45 to IT equipment port 2, located in RU position 24, rack AM45</p>

Implementation Guidance

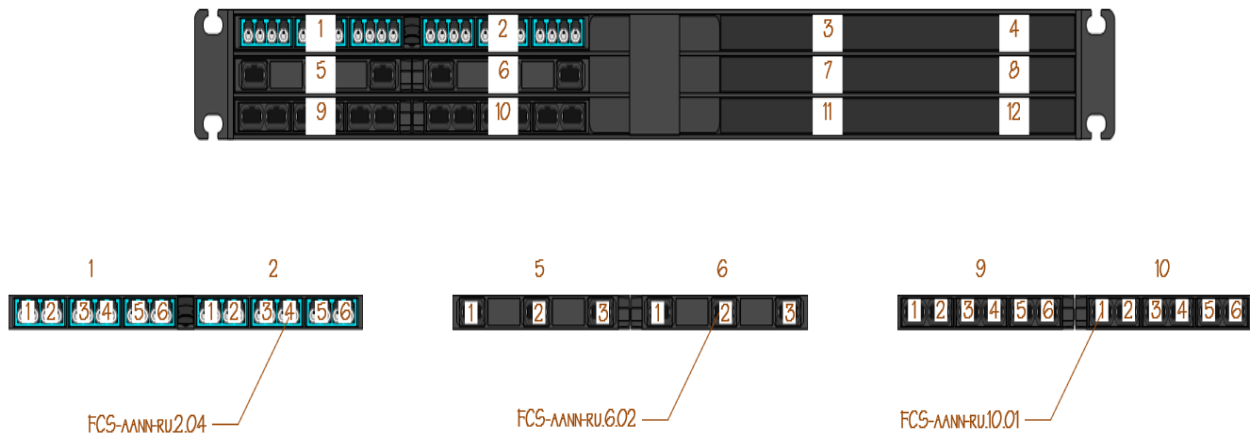

Figure 28. Fiber Panel Slot Location ID Numbering Example

5.2.4 Power Distribution Identification

This section identifies power distribution components and associated elements covered under the ISTS. Power distribution includes, but may not be limited to, active and passive facilities equipment that transfers electricity from source equipment and panels to the terminal receptacles on rack-mounted power distribution assemblies. Associated elements include, but may not be limited to, PDUs, distribution panels, power whips, and in-rack power distribution systems.



Identification of power distribution is limited to physical location of the equipment and not to power chain relationships. Power chain relationships will be elaborated upon in a future standard revision.

Table 48: Power Distribution Identification Conventions

ID	Primary Attribute	Secondary Attribute	Specification
1	Power Distribution Source (data center level)	Power Distribution Unit (PDU)	<p>Label: PDU-xxxx</p> <ul style="list-style-type: none"> • PDU designates Power Distribution Unit • xxxx is the host name matching the VA naming convention for networked PDUs within the facility or local naming convention for non-networked PDUs. In facilities with multiple (A/B) bus distribution to the IT equipment, local naming conventions should indicate which bus the power is supplied from. <p>Example: PDU-3A</p>
		Remote Distribution Cabinet (RDC)	<p>Label: RDC-xxxx</p> <ul style="list-style-type: none"> • RDC designates a Remote Distribution Cabinet, which is a stand-alone expansion distribution panel unit fed from a sub-feed breaker in a PDU • xxxx is the local naming convention for the RDC within the facility. The typical RDC designator will be a sub-designation of the parent PDU, i.e., RDC-3A-1 indicates an RDC fed from sub-feed breaker 1 on PDU3A <p>Example: RDC-3A-1</p>
		Distribution Panel (DP)/ Branch Circuit Panelboards (BCP)/ Remote Power Panels (RPP)	<p>Label: DP-xxxx</p> <ul style="list-style-type: none"> • DP designates a wall-mounted distribution panel fed from an upstream DP, sub-feed breaker in a PDU, or other similar source • xxxx is the local naming convention for the DP within the facility <p>Example: DP-CR3A</p> <p><i>Note: Naming conventions for DPs at the facility or data center level are not specified.</i></p>



ID	Primary Attribute	Secondary Attribute	Specification
		Busway	<p>Label: BUS-xxxx</p> <ul style="list-style-type: none"> • BUS designates an overhead power distribution busway, which is a ceiling-mounted conductor enclosure fed from an upstream distribution panel, sub-feed breaker in a PDU, or other similar source, to which individual ‘taps’ with integral power whips are attached • xxxx is the local naming convention for the busway within the facility <p>Example: BUS-ROW3</p> <p><i>Note: Busways are typically associated with rows of IT equipment</i></p>
		Power Tap	<p>Label: TP[ELEMENT1]/[ELEMENT2]</p> <ul style="list-style-type: none"> • TP designates a power tap off a power busway system • ELEMENT components select the source (ELEMENT1) and powered item (ELEMENT2) using nomenclature described elsewhere in this specification. Many combinations of taps are possible using this designation depending upon the specific power distribution schema used in individual data center facilities. <p>Example: TP[BUS-xxxx]/[RPDU-aann.gl.zn]</p> <p><i>Note: There are two busways per row in a small data center so a busway element example would be [BUS-03A] or [BUS-03B] to identify the 03 A- or B-busway. However, in larger data centers there are multiple pods in rows along each line. In that case BUS-03A1, BUS-03A2, etc. will identify which pod along the 03 line is specified.</i></p>
2	Power Distribution Source (rack/enclosure level)	Zone Power Distribution Unit (zPDU)	<p>Label: ZPDU-aann.ru</p> <ul style="list-style-type: none"> • ZPDU designates a Zone Power Distribution Unit, which is a rack-mounted unit allowing A/B distribution to standard and HD power distribution topologies • aann designates terminal locations by rack or cabinet identifier • ru is the RU where a horizontal ZPDU is installed in the rack or cabinets viewed from the rear of the rack <p>Example: ZPDU-AM45.03 is a horizontal ZPDU installed in rackAM45 at RU position 03</p>



ID	Primary Attribute	Secondary Attribute	Specification
		Subzone Vertical Rack Power Distribution Unit (rPDU)	<p>Label: RPDU-aann.gl.zn or RPDU-aann.aann.gl.zn</p> <ul style="list-style-type: none"> • RPDU designates Rack Power Distribution Unit, which is a distribution power strip that power cords from terminal IT equipment plug into • aann designates terminal locations by rack or cabinet identifier • gl is the group and leg designation as labeled on the zPDU outlet connected to the rack-mounted PDU • z designates left or right (L or R) mounting of the PDU • n is the number of the PDU starting at the rear of the rack <p>Example: RPDU-AR16.A2.L2 is the second power strip mounted on the left of the rack connecting to the zPDU's A bus in rack</p> <ul style="list-style-type: none"> • RPDU-aann.yx.zn (Alternative, when no zPDU is present, ie., direct connection from rPDU to a power whip from a DP, RDC, or PDU) -y designates the power bus to which the rPDU is connected. Where there is a single bus supporting a space, the bus is denoted as "A". Multiple busses will be "A" and "B". • -x designates the number of the rPDU, in that rack, on that bus. The first rPDU in the cabinet on the bus is number 1, the second 2, and so on. If no zPDU is present (direct connection from the rPDU to a power whip from a DP, RDC, or PDU), this refers to the power strip. <p>Example: RPDU-AR16.A2.L1 is the second power strip on the A Bus, and is the first power strip on the Left side in the rear of cabinet AR16</p> <p>Example: RPDU-AR18.B1.R2 is the first power strip on the B Bus, and is the second power strip on the Right side in the rear of cabinet AR18</p>



ID	Primary Attribute	Secondary Attribute	Specification
3	Power Distribution (conductors)	Power Whips	<p>Label: WHIP[ELEMENT1]/[ELEMENT2]</p> <ul style="list-style-type: none"> • WHIP designates a set of electrical conductors in a conduit or other flexible power cord assembly intended to move electricity from a distribution point to a point-of-use component • ELEMENT components select the source (ELEMENT1) and powered item (ELEMENT2) using nomenclature described elsewhere in this specification. For example, they may be written as [PDU-xxx.aa,bb,cc]/[ZPDU-aann.ru]. Many combinations of whips are possible using this designation depending upon the specific power distribution schema used in individual data center facilities. • aa,bb,cc is the set of circuit breaker positions used at the source end corresponding to the positions in the breaker panel, if applicable. For whips beginning at a busway tap, do not use the .aa,bb,cc portion of the designator <p>Example: WHIP[PDU-3A.13,15,17]/[ZPDU-AR14-03] Power whip connecting three-pole circuit breaker in positions 13, 15, and 17 in PDU-3A to zPDU in rack AR14 located at position RU03</p>
		Power Cords (from rPDU to IT Equipment)	Not Defined



5.2.4.1 IT Equipment In-Rack/In-Cabinet Power Distribution Labeling

Rack power information shall be labeled on each individual vertical rPDU, on the frame behind the door, front and back, as well as on the doors, front and back. Machine-printed paper tags secured with clear plastic or acetate adhesive tape are the minimum standard for these tags. Hand written labels of any type are not permitted.

Alternative IT equipment (non-rack based) shall be labeled with physical location (grid identification) and power distribution sources and with any additional identifying information needed to identify that specific piece of equipment. Install power designator labels near or on the power cord leaving the equipment. Place equipment location tags on the front top, or at location associated with the first full tile closest to the origin.

5.2.4.2 Power Distribution to IT Labeling

Data center power distribution components such as breakers, switches, receptacle junction boxes, and IT equipment power circuits (“whips”) shall be labeled with approved machine generated adhesive tape, cable tags or other approved method. Hand written labels of any type are not permitted.

All non-IT power distribution in the data center space should be labeled in the same manner to ensure a safe environment. All electrical equipment which is served by, or which contains multiple sources of power, shall comply with NFPA 70 standards to identify both disconnecting means.

The source end of each whip shall be labeled within 3 ft of the conduit leaving the distribution panel enclosure. The point-of-use end of each whip shall be labeled on the junction box, on the connector, or within 1 ft of the end of the conduit.

Labels installed internal to electrical or electronic components shall not provide a ground or short circuit path or interfere with the operation of components.

5.2.5 Data Communications Cabling Labeling

The Administration Standards specify use of ANSI/TIA-606-C compatible formats for identifying data communications cabling. (More complicated installations may require reference to that document.) Data communications cabling (UTP, fiber, and other) shall be labeled on both ends with information about the network port that it connects to on each end. Machine-printed paper tags secured with clear plastic or acetate adhesive tape are the minimum standard for these tags as in Figure 29 below. Handwritten labels of any type are not permitted.





Parallel (in-line) labels – preferred



“Flag” labels – not preferred

Figure 29: Example of Communications Cable Labeling

IT equipment (including switch and patch panel) network ports shall be individually identified from manufacturer information, typically provided in equipment drawings available for integration with rack elevation drawings and a DCIM tool. Where not otherwise provided, cardinally number ports along the top row from left-to-right, then along the next row down from left-to-right, and so forth.

Equipment ports and the cables in each (if any) are denoted by the equipment position with the additional identifier xx. Thus, a cable end will be labeled in VA-modified ANSI/TIA-606-C compliant format [aann-ru.xx].

To identify the connected path of each data communications cable, the physical position identifiers at both ends are needed. The label for each cable shall identify the near side (NS) location and the far side (FS) location in VA-modified ANSI/TIA-606-C compatible format (e.g., “NS/FS”). Therefore, a UTP patch cord going from AD02-35 port 10 to patch panel BD02-19 port 04 would be identified (on the near end) as CCA[AD02-35.10]/[BD02-19.04], and labeled (on the far end) as CCA[BD02-19.04]/[AD02-35.10]. Automated systems adopted within VA shall understand the reciprocal relationship in these identifiers as representing a single connection.

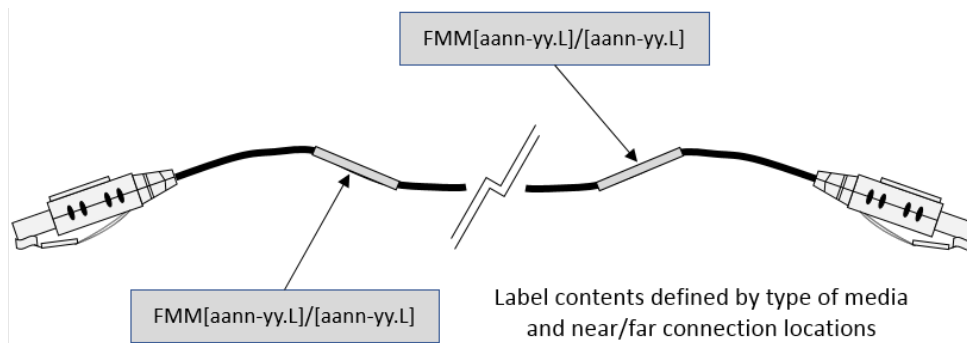

Figure 30: Detailed Example of Communications Cable Labeling



5.2.6 IT Equipment Rack/Cabinet Labeling

To cross-identify network and IT equipment enclosures (hereafter, generically referred to as 'racks') located on the floor with critical safety information (including power sources), each rack shall be labeled with its physical location (grid identification) and power distribution sources. Rack identifying physical location shall be posted on both the front and rear of each rack, on the frame above or at the top of the door (as applicable).

5.2.7 Power Whip IT Equipment In-Rack/In-Cabinet Power Distribution Labeling

Rack power information shall be labeled on each individual vertical rPDU, on the frame behind the door, front and back, as well as on the doors, front and back. Machine-printed paper tags secured with clear plastic or acetate adhesive tape are the minimum standard for these tags. Hand written labels of any type are not permitted.

Alternative IT equipment (non-rack based) shall be labeled with physical location (grid identification) and power distribution sources and with any additional identifying information needed to identify that specific piece of equipment. Install power designator labels near or on the power cord leaving the equipment. Place equipment location tags on the front top, or at location associated with the first full tile closest to the origin.

5.2.8 Power Distribution to IT Labeling

Data center power distribution components such as breakers, switches, receptacle junction boxes, and IT equipment power circuits ("whips") shall be labeled with approved machine generated adhesive tape, cable tags or other approved method. Hand written labels of any type are not permitted.

All non-IT power distribution in the data center space should be labeled in the same manner to ensure a safe environment. All electrical equipment which is served by, or which contains multiple sources of power, shall comply with NFPA 70 standards to identify both disconnecting means.

The source end of each whip shall be labeled within 3 ft of the conduit leaving the distribution panel enclosure. The point-of-use end of each whip shall be labeled on the junction box, on the connector, or within 1 ft of the end of the conduit.

Labels installed internal to electrical or electronic components shall not provide a ground or short circuit path or interfere with the operation of components.

5.2.9 Physical Label Format

Labels on power whips shall contain the following information:

- PDU/Panel Source
- Circuit Number
- Whip Length
- Equipment Location
- Receptacle Type



Figure 31 below shows an example of a self-adhesive label for use on a whip. There is no prescribed format for these labels.

PDU/Panel Source:	PDU A-3 Panel 2	
Circuit Number:	2,4,6	Length: 50'
Equipment Location:	Rack E8	
Receptacle Type:	L21-30R	

Figure 31: Power Whip Label Example

5.3 Management Standards

5.3.1 Color Coded Identification

Table 49: Color Identification Conventions

ID	Primary Attribute	Secondary Attribute	Specification
1	Color Identification	Backbone Telecommunications Cabling	See Table 32
		Telecommunications Patch Cabling	Not specified, follow local site schema
		Power Distribution	Colors shall be black on A-side and other distinguishable color on B-side to differentiate electrical bus power sources

5.3.1.1 Data Communication Cabling Color Coding

The ISTS does not specify an enterprise color scheme for UTP patch cords. Color coding scheme for patch cords should be avoided, however; individual site schemas are acceptable if consistent and documented.

5.3.1.2 Power Distribution Color Coding

All redundant power distribution within the computing spaces shall incorporate specific color identification to differentiate between different electrical bus power types. Use of specific color identification for each electrical bus shall stay consistent throughout building distribution. No enterprise color specification is prescribed. A suggested strategy is to use blue Liquid-tight Flexible Metal Conduit (LFMC) conduit for A-bus circuits and grey LFMC conduit for B-bus circuits. Use of different label colors to differentiate electrical bus power is an acceptable solution.

Within IT equipment racks/cabinets, separate A-side and B-side power and segregate equipment power cords (between vertical rack power distribution units and IT equipment) by color (black on A-side and other distinguishable color on B-side) for identification of A/B power to each piece of IT equipment (see example below). Follow best practices for managing the power cords similarly to other cabling.



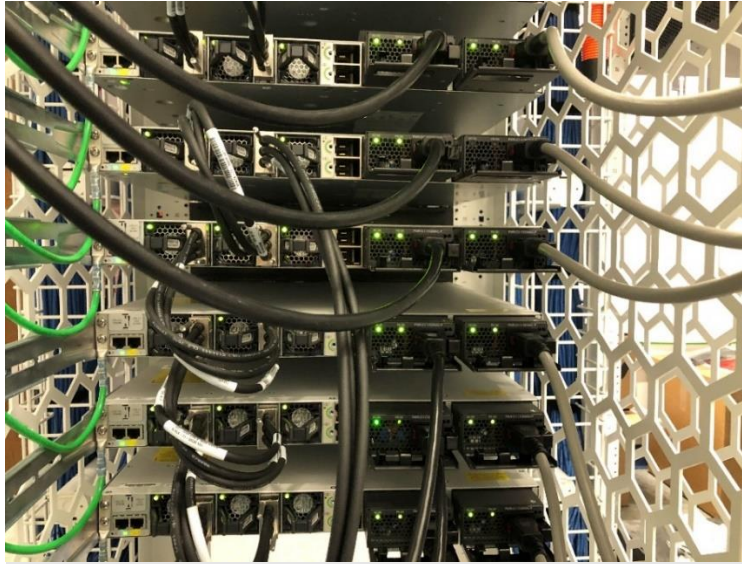

Figure 32. Example of Best-Practice Differentiated Power Cord Coloration Implementation

5.3.2 Management of Telecommunications Cabling

Cable management is largely qualitative in nature, requiring the exercise of judgment by IT staff. Proper cable management is necessary to enable optimal airflow through IT equipment (minimizing energy usage), to allow identification and management of cabling throughout the IT equipment lifecycle, and to minimize risks of damage to the networking system by minimizing opportunities for damage to cables, connectors, and conveyances. Aesthetically, proper cable management reflects the professional approach expected and necessary to support the mission of providing the best possible IT support to the Veteran.

Evaluation Factors

- Cable management allows appropriate airflow
- Cables properly labeled to allow easy identification
- Cable management is organized, logical, systematic, and aesthetic

Implementation Guidance

Cabling plants shall be planned to enable the installation of IT equipment. Install and utilize cable conveyances (cable trays, cable managers, and similar) in all IT installations. Free-run telecommunications cabling is not maintainable or sustainable and has a higher lifecycle cost than properly designed and installed cabling plant systems.

- Cabling shall be run in horizontal, vertical, or overhead cable management systems where available. Procure and install cable management equipment when cabling installations need such to enable aesthetic, managed cabling outcomes.
- Always plan the cabling path and manage the cabling installation, down to the level of the patch cord to the individual piece of IT equipment. Individual cables shall not be free-run.

- Individual cable lengths shall be selected appropriately for their purpose. Cable slack shall be managed with attention to installation criteria such as bend radius. Excessive slack indicates a poor choice of cable length.
- Patch cords shall not be run from one IT equipment rack to another.
- Power cords shall not be run from one IT equipment rack to another. Power distribution specifically calls out zPDUs that supply power to multiple racks to obtain maximum power densities. These devices and their power supplies are not affected by this guidance.
- Power cords shall be matched to the manufacturer specifications for the hardware receptacles intended without the use of adapters.
- Patch and power cords shall not be left unmanaged where they may interfere with exhaust airflow or have the potential to catch or snag on people or equipment.
- Document all cabling components and their linkage between components and make sure that this information is updated on a regular basis. The installation, labeling, and documentation should always match. Maintain cabling documentation, labeling, and logical/physical cabling diagrams.
- No enterprise color scheme is specified for UTP patch cords. Where a local or organizational color scheme for cabling exists, it shall be followed. Color schemes for patch cords should be avoided.
- Consider vendor-specific IT equipment requirements for cabling so as not to impede intended operation of that equipment, such as blocking exhaust ports. For example, cabling management in the picture below is appropriate except for the aqua-colored cables entering from the left, which cover the fan module on the left of the switch. This keeps the fan module from being replaced without disconnecting the network.

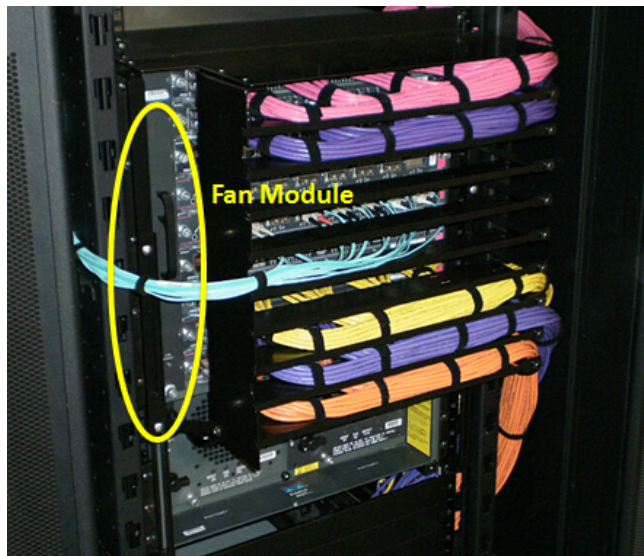

Figure 33: Equipment-Specific Cable Management Requirements

Below (Figure 34) are examples of aesthetically *acceptable* cabling management implementations. No installation is ever optimal for all considerations, but these represent the level of workmanship expected in the VA computer room environment.



Figure 34: Acceptable Cable Management Results

Below (Figure 35) are examples of *unacceptable* cabling management implementations that will require remediation.

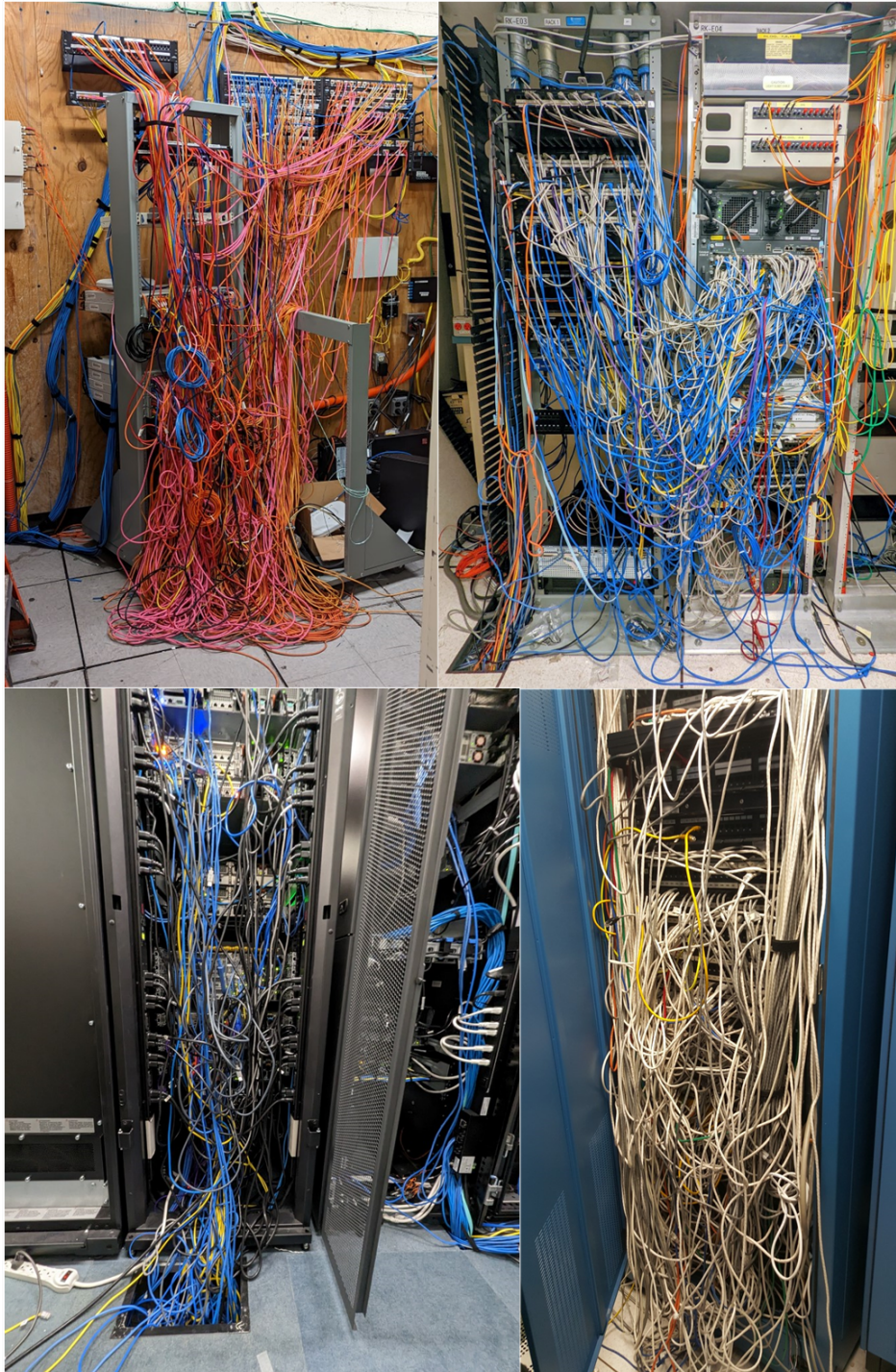

Figure 35. Unacceptable Cable Management Results

5.3.2.1 Installation Guidance

- Cross-connects are only authorized at the MDAs, HDAs, TRs, and entrance rooms.
- No splicing or intermediate cross-connecting are authorized for intra-building or inter-building connectivity.
- All TRs shall be connected directly to the MDAs.
- All cabling shall be installed in a neat, workmanlike manner without twists, kinks, and unnecessary crossovers.
- Cables should not be in contact with the ground. Use cable management components and techniques to maintain a clean, clear, and safe work environment.
- Do not mount cabling in locations that block access to other equipment (e.g., power strip or fans) inside and outside the racks.
- Patch cords should follow the side of the IT equipment rack closest to the assigned network interface card.
- Cables should not be looped around themselves or other objects.
- Route cables with gentle loops to avoid damage due to exceeding bend radius limitations. Glass fiber can be easily broken with rough handling or overly tight bends.
- Cables should be tight enough to maintain position but not tight enough to deform the jacket or put tension on the connectors.
- Based on heat exhaust (airflow), serviceability, and excess cable lengths, do not install folding/retractable cable management arms for IT equipment in VA computer spaces. Arms currently installed on existing equipment may be used until the equipment is refreshed and removed.
- All cable slack should be concealed within the rack either vertically or within cable managers. Slack should not be looped. With use of the correct length cables, there should not be sufficient slack to enable looping.
- Use the correct length patch cords.
- Cables should not be twisted or wrapped around other cables, including when bundled.

5.3.2.2 Cable Bundling Guidance

- Bundle cables together in groups of relevance (for example, cables to a single equipment distributor or uplinks to core devices), as this will ease management and troubleshooting.
- Bundles of cables, when necessary, should be built from sub-bundles of no more than 6-8 individual cables. The larger bundles should not exceed four sub-bundles of like quantity.
- When bundling or securing cables, use Velcro-based ties not more than every 3 ft (1 m) to 6 ft (2 m), and more frequently as needed to maintain a clean installation. Do not use zip ties or twist ties for cable bundling or securing, as these apply pressure on the cables.
- Only bundle like cable types. Do not bundle fiber, power, and UTP together.
- Cable labels shall be visually accessible to local personnel following installation, for future identification and troubleshooting purposes. Rather than bundling groups of cabling in a manner that prevents identification of individual cables, bundle in a different manner and/or relocate the cabling to locations where they will not be obscured. Consider bundling so all cables are on the exterior of the bundle, so they are visible as shown in Figure 36 below. The exception to this is when factory pre-bundled cabling is used.



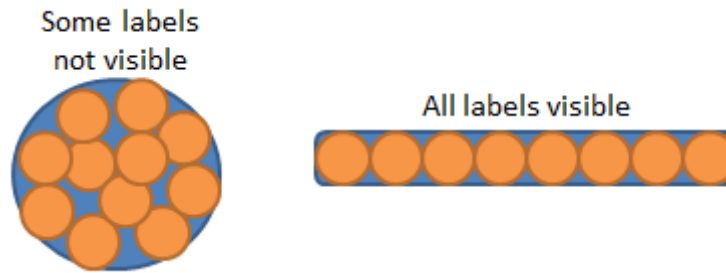

Figure 36: Cable Labels in Bundles

5.3.2.3 Unshielded Twisted Pair, Fiber, and Power Cabling Guidance

- Segregate power and telecommunications cabling in separate cable tray systems; use different conveyance systems located not less than 1 ft apart when these two systems are run in parallel.
- Where possible, run power and telecommunications in separate paths to reduce risks of Electromagnetic Interference (EMI)/Radio Frequency Interference (RFI) and data transmission losses.
- Do not install UTP cabling on top of fiber cabling to prevent damage to the fiber transmission medium.
- Segregate UTP and fiber telecommunications cabling, using different conveyances where possible. Where not possible or provided, ensure fiber cable is protected from damage. Use fiber innerduct where necessary within the same cabling conveyance.
- Use properly-sized equipment power cords; use of 6 ft length power cords where 2 ft cords are needed is not considered a best practice.
- Separate A-side and B-side power and segregate equipment power cords (between vertical rack power distribution units and IT equipment) by color for identification of A/B power to each piece of IT equipment. Follow best practices for managing the power cords similarly to other cabling.

5.3.3 Management of Airflow

VA computing facilities shall utilize engineered, verified layout designs to optimize energy usage in the environmental control systems supporting the facilities. Proposed deviation from standard layout design requires verification and validation by DCIE and CFD analysis.

Evaluation Factors

- Designated hot and cold aisles are utilized in facilities with more than eight IT equipment rack/cabinet equivalents.
- Perforated floor tiles and similar vents are strategically placed to prevent cooling air supply is not directly mixed with return air
- Blanking panels and air dams are deployed in all IT equipment cabinets to minimize bypass air across the surface area of the cabinets.

Implementation Guidance

Unless otherwise designated through validated engineering design, utilize a hot/cold aisle arrangement for equipment located in VA data centers. This applies to both facilities that use a raised access floor plenum for cooling distribution and those that do not.

5.3.4 Physical Access to Telecommunications Spaces

VA telecommunications spaces are intended to support all distributed equipment telecommunications requirements of all users of the facility in a combined manner. Separate telecommunications spaces to support individual functions are unnecessary and wasteful of limited resources. Multiple data centers (computer rooms) on a campus or supporting a single facility are prohibited.

Distributed equipment systems of all facility stakeholders (e.g., nurse call, telemetry, distributed antenna systems, security systems, other 'special telecommunications systems,') and backbone/horizontal distribution for all these types of systems are deployed to the same TR.

Administrative solutions to physical access to VA telecommunications spaces for all user groups with valid technical reasons to routinely access the spaces (e.g., OIT, FMS, CE, R&D, police, custodial staff, etc.) are required to support mission requirements.

5.3.5 Custodial Services

Custodial services are required to be provided for telecommunications spaces:

- Clean floors to prevent an excessive buildup of dust, dirt, or floor finish on floor surface, along walls, and in corners. Ensure electrostatic discharge coating for raised floor systems and static dissipative coating or material for slab floors and other qualities of the surface are maintained as designed.
- Remove accumulation of dust, dirt, grime marks, streaks, smudges, or fingerprints from all vertical and horizontal surfaces.
- Empty all trash containers.
- Dust lights and fixtures.
- Replacement of burned-out lamps.



Appendix A: Request for Variance

A.1 Request for Variance from Infrastructure Standards

An updated printable [Request for Variance form](#) has moved to permanent storage on the Technical Information Library (TIL).

Requests for variance for allowable deviations from specific requirements of any standards published within may be authorized where a proposed alternate method of installation or operation will provide equal or higher safety, reliability, redundancy, or sustainability objectives. Requests for variance shall be submitted for consideration to DCIE (VAITSEDatacenterEngineering2@va.gov) using a [Request for Variance form](#). If a variance is granted, it shall be limited to the particular site and installation covered in the application and will NOT be considered as a precedent for other installations.

Note: This is a separate process from VHA's process and form for requesting variances from other TIL standards and design manuals.

A.2 Request for Change to Infrastructure Standards for Telecommunications Spaces

Requests for changes shall also be submitted to DCIE (VAITSEDatacenterEngineering2@va.gov) for consideration using a [Request for Variance form](#). If approved, the proposed change(s) will be ratified through the Enterprise Baseline and Standard Review (EBSR) process and submitted to the Enterprise Change Advisory Board (CAB) for final approval (if required) before publication.



Appendix B: OIT Design Guide Templates

B.1 Design Narrative

The Data Center and Infrastructure Engineering (DCIE) team has developed the [OIT Design Guide Templates for Critical Infrastructure in Telecommunications Spaces](#), also located at this link in the Technical Information Library, for Architect/Engineer (A/E) partners to use in their data center design drawing development for new construction, restoration, and modernization projects across VA. These generic Main Computer Room (MCR), entrance room, and Telecommunications Rooms (TR) designs can be applied without significant modifications to future construction projects.

The existence of a standardized, standards-based design will prevent non-compliant, incorrectly sized, unbalanced, and unsustainable data center designs from being produced by VA mission partners, will reduce design project timelines and costs, and prevent unnecessary rework and change orders.

These designs utilize a standardized ANSI/TIA-942-B Telecommunications-Electrical-Architectural-Mechanical (TEAM) approach that will allow A/E designs to separate requirements by discipline. Disciplines not directly related to the telecommunications infrastructure (e.g., structural, plumbing, fire protection) are not addressed. The use of these templated layouts and outfitting plans is required for VA telecommunications space design, construction, and modernization efforts. They provide a ninety percent solution for most designs; however, projects in the planning, design, or implementation phases shall contact DCIE for additional assistance in telecommunications space design and standards compliance.

Iterative CFD analysis shall be used to determine heat rejection equipment sizing, layout, and operating parameters to minimize energy usage by the mechanical systems when templates cannot be used without modification for CDC, CSC, and MSC data center classifications.

Transmit all communications to DCIE at VAITESDatacenterEngineering2@va.gov.

B.2 Main Computer Rooms

Main Computer Rooms (MCR) serve as Campus Support Centers (CSC) and provide IT services for most typical VA Medical Center (VAMC) campuses.

These spaces are intended to provide for collocation of IT equipment and systems from all provider organizations including VAMCs, VBA Regional Offices, Office of Information Field Office (OIFO), R&D, Police, Security, local FMS, Health Informatics, CE, etc. into the minimum number of operational spaces on a campus; that is, consolidated data centers providing environmental and area network support appropriate to all IT equipment needed by tenant organizations on a particular campus to perform their missions. Legacy MCRs typically support between 25 kW and 75 kW of critical load, with significant additional loads anticipated as VA modernizes electronic health record systems and deploys additional medical systems increasingly dependent upon IT systems.



Analysis of IT trends and projected needs has led VA to standardize on a single CSC design appropriate for an estimated 90 % of VAMCs' needs for a twenty-year data center life cycle. Most medical centers will require a 'small' design to support their IT requirements (see Sheet 09, Small Data Center). Only a few will require larger design sizes or capabilities. Unless otherwise indicated by DCIE, utilize a 'small' design for computer rooms to support VAMCs. Consult DCIE for design details for this type of facility.

For Ambulatory Care Centers (ACCs), Health Care Centers (HCCs), Community Based Outpatient Centers (CBOCs), and other classifications of VA healthcare facilities that may provide limited clinical services, an 'extra-small' design or smaller footprint will typically be appropriate. Guidance for these generally smaller healthcare facilities may be found in VA's Lease Design Narrative (LDN). Consult DCIE for design details for non-leased facility design efforts.

For Core Data Centers (CDC) and Mission Support Centers (MSC), consult DCIE for the appropriate size and design during project scoping for these classifications.

B.3 Entrance Rooms

Entrance rooms are a subset of the NSC classification archetype with less stringent temperature range requirements. Entrance rooms have the additional requirement of matching the electrical distribution and heat rejection redundancy requirements of the computer room that they support.

In new construction, the entrance rooms require special consideration for earlier beneficial occupancy than other building functions. Plan completion of construction and outfitting of entrance rooms to occur earlier in projects than for other telecommunications spaces. Entrance room outfitting must be complete by the time that carrier circuits and carrier equipment from service providers are brought onto campus, allowing other systems to be tested and commissioned.

Carrier circuits shall be terminated in entrance rooms generally located in the same building as the MCR.

There shall be a minimum of one entrance room per campus. Individual buildings do not require separate entrance rooms, as VA does not use building distributors in its design for the converged physical telecommunications infrastructure. Entrance rooms shall be a minimum of 80 ft² for a one-rack entrance room and an additional 20 ft² for each additional rack required (see sheet four).

Two entrance rooms are required for the diverse providers for CDCs and CSCs with a minimum separation of 66 ft (20 m) between entrance points and entrance rooms. Entrance points located 180° apart (on opposite sides of a building) are preferred, both to service entrance rooms and in buildings supported by the campus backbone.

Health care facility entrance rooms shall be a minimum of 170 ft². See Sheet 04, Telecommunications Entrance Rooms, for construction and outfitting guidance for these redundant entrance rooms.



Follow guidance for the NSC telecommunications space classification (and entrance room specific exceptions) in the Standard for electrical distribution and environmental control requirements for these spaces.

B.4 Antenna Entrance Rooms

Antenna entrance rooms are a subset of the NSC classification archetype with less stringent temperature range requirements. Antenna entrance rooms are the telecommunications entrance room for roof-mounted antenna, microwave, satellite dish, and other telecommunications services mounted at the roof level. They accommodate all provided and planned Radio Frequency (RF) based systems and headend equipment cabinets housing cellular reinforcement Distributed Antenna System (DAS), Master Antenna Television (MATV), Television Receive Only Master Antenna Satellite Television (TVRO), Very Small Aperture Terminal (VSAT), High Frequency (HF), microwave, Radio Entertainment Distribution (RED), Public Address (PA), Two-Way Radio, Radio Paging System (RPS), and Video Surveillance Systems including Closed Circuit Television (CCTV), Security Surveillance Television (SSTV), etc.

This room will have the same TIA-942 rating as lower entrance rooms, but will have additional power, racks, and bonding to support the associated carrier and radio equipment. Where feasible, all signal amplifiers, carrier equipment, cellular transceivers, etc. for intrabuilding DAS and public access cellular service should be installed in this entrance room. Generally, a single antenna entrance room shall be present for a medical center and other large healthcare facilities.

See Sheet 07, Antenna Entrance Room, for construction and outfitting guidance for these entrance rooms.

B.5 Telecommunications Rooms

Backbone media from the MCR terminates in Telecommunications Rooms (TR) distributed around the buildings on campus, which provide horizontal distribution media to end-user WAOs.

There shall be a minimum of one TR per floor. Telecommunications rooms shall be a minimum of 80 ft² for a one-rack TR and an additional 20 ft² for each additional rack required (see Sheet 5 of Appendix B).

Health care facility TRs shall be a minimum of 170 ft².

Telecommunications Room construction and outfitting requirements are detailed in sheet five of Appendix B. Follow guidance for the NSC telecommunications space classification in the Standard for electrical distribution and environmental control requirements for these spaces.

Multiple organizations including Veterans Affairs Medical Centers (VAMC), VBA Regional Offices, Office of Information Field Office (OIFO), Research & Development (R&D), Police, Security, local Facilities Management Service (FMS), Health Informatics, CE, etc. use TRs for their distribution, security camera feeds, cable TV, etc. The TRs are intended to provide for collocation of IT equipment and systems from all provider organizations into the minimum number of operational spaces on a campus; that is, consolidated TRs providing environmental



and area network support appropriate to all IT equipment needed by tenant organizations in the TRs to perform their missions.

VA TRs are intended to support all distributed equipment telecommunications requirements of all users of the facility in a combined manner. Separate TRs to support individual functions (e.g., OIT, FMS, CE) are unnecessary and wasteful of limited resources.

Distributed equipment systems of all facility stakeholders (e.g., CE, nurse call, telemetry, distributed antenna systems, security systems, other 'special telecommunications systems,' and backbone/horizontal distribution for all of these types of systems) are deployed to the same TR. End-user devices for these systems shall be connected via horizontal distribution from the TR serving the zone in which the device(s) are located.

Administrative solutions to physical access to VA telecommunications spaces for all user groups with valid technical reasons to routinely access the spaces (e.g., OIT, FMS, CE, R&D, police, custodial staff, etc.) are required to support mission requirements.

B.6 Telecommunications Enclosures

Standardized Telecommunications Enclosures (TEs) are authorized for use in lieu of a TR in specific limited circumstances where a standard TR is not feasible or warranted for the telecommunications space.

See Sheets 12-17, Telecommunications Enclosures, for construction and outfitting guidance for TEs.

Implementation Guidance

Space classification. Telecommunications Enclosure (TEs) may be deployed to the following types of non-healthcare spaces (any space below may also be granted a variance to use a TR less than 80 ft² as long as the excepted clearance requirements are maintained and the maximum of 96 WAOs is not exceeded):

- Parking structures
- Technical spaces such as warehouses, kitchens, laundries, mechanical/electrical plant buildings, chiller or boiler plants, garages, and paint shops
- Historical quarters converted to administrative use
- Buildings with no or limited VA staffing presence and limited connectivity requirements such as gyms, auditoriums, chapels, etc.
- Temporary modular trailers (Temporary buildings and trailers must be validated to be actually temporary, with a planned date of removal and no history of previously deferred or canceled removal plans)
- NCA field facilities
- Fisher House buildings
- VHA mental health administration facilities (veterans centers)

A maximum of 96 WAOs can be supported by a standardized TE. Each data jack in a workspace telecommunications outlet, wired back to the patch panels in the TE, is considered a WAO for



these purposes. Where 1-48 WAOs are planned, a 12RU (half-height) standardized TE is used. Where 49-96 WAOs are planned, a 26RU (full-height) standardized TE is used.

No services other than VA LAN horizontal distribution can be supported from a standardized TE, except in a building with no VA staffing presence and no requirements for VA LAN but where guest WiFi is provided.

TEs may be deployed to spaces falling within the environmental envelope conditions for a TR, as described in the ISTS. Ambient air conditions in the space are between 41 °F - 95 °F dry bulb, 8 % - 80 % RH, and a dew point less than 82.4 °F.

Non-standard environmentally conditioned TEs may be approved by variance for use in spaces where the ambient air conditions extend outside of these limits.

All knockouts and cable entry points shall be sealed to prevent liquid and dust entry.

Accessories include cable port brush kit, low-noise dual fan and filter kit, replacement filter kit, shelves, vertical rail-mounted cable managers, and LED light kit.

Criteria requirements for diverse path backbone:

- Supports VA clinical staff function in a healthcare setting
- Supports VA clinical-supporting staff function with end-user desktop and/or VOIP phone requirement
- Supports VA administrative staff function with end-user desktop and/or VOIP phone requirement (reduced fiber count routing may be considered if space cannot be used for a healthcare/clinical function, e.g., Washington DC administrative buildings, VBA regional office buildings)
- Not required for patient-only areas without any VA staffing function presence (non-diverse and reduced fiber count routing may be considered)
- Not required for VA technician, maintenance, or trades areas or facilities (non-diverse and reduced fiber count routing may be considered)



Appendix C: Figures, Tables, & Other References

C.1 Figures

<i>Figure 1: Generic Redundancy Level Standards for Physical Plants, Facilities, and Infrastructure Systems</i>	16
<i>Figure 2: Hot Aisle/Cold Aisle Approach</i>	30
<i>Figure 3: Power Distribution Options- Simplified Visualization (CDC, CSC, MSC)</i>	37
<i>Figure 4: Standard Density Underfloor/Whip Distribution Topology (CDC, CSC, MSC) – 60 A Zone PDU</i>	38
<i>Figure 5: Standard Density Underfloor/Whip Distribution Topology (CDC, CSC, MSC) – 30 A Zone PDU</i> ...	38
<i>Figure 6: High Density Underfloor/Whip Distribution Topology (CDC, CSC, MSC) – 60 A Zone PDU</i>	39
<i>Figure 7: High Density Underfloor/Whip Distribution Topology (CDC, CSC, MSC) – 30 A Zone PDU</i>	39
<i>Figure 8: Whip Distribution Topology with In-Rack UPS (NSC, TR, Entrance Room) – 60 A Zone PDU</i>	40
<i>Figure 9: Whip Distribution Topology with In-Rack UPS (NSC, TR, Entrance Room) – 30 A Zone PDU</i>	41
<i>Figure 10: Single Rack Whip Distribution Topology with In-Rack UPS (NSC, TR, Entrance Room) – 20 A Circuits</i>	41
<i>Figure 11: International Electrotechnical Commission (IEC) Standard C13/14 Cord Set</i>	53
<i>Figure 12: Typical Bonding Connection</i>	57
<i>Figure 13: Typical Rack Bonding Layout</i>	58
<i>Figure 14: Typical Bonding Requirements for IT Equipment Enclosures</i>	58
<i>Figure 15: OEM Equipment Ground Lug Connection</i>	59
<i>Figure 16: OEM Equipment Ground Connection</i>	60
<i>Figure 17: Primary Bonding Busbar</i>	60
<i>Figure 18: Power Usage Effectiveness</i>	69
<i>Figure 19: VA-Modified ASHRAE Environmental Classes for Data Center Applications</i>	71
<i>Figure 20: Brushed Floor Grommet</i>	81
<i>Figure 21: Air Dam Foam</i>	82
<i>Figure 22: Blanking Panel Application</i>	83
<i>Figure 23: Method A Polarity of Horizontal Pre-terminated MPO-based Fiber Optic Cabling</i>	102
<i>Figure 24: Method A Polarity End to End Connectivity (A-B and A-A Patch Cords Required)</i>	102
<i>Figure 25: Polarity of Fiber Optic Patch Cord</i>	105
<i>Figure 26: Typical Position Identification Examples</i>	124



Figure 27: Rack Unit Identification Example..... 135

Figure 28. Fiber Panel Slot Location ID Numbering Example..... 140

Figure 29: Example of Communications Cable Labeling..... 146

Figure 30: Detailed Example of Communications Cable Labeling 146

Figure 31: Power Whip Label Example..... 148

Figure 32. Example of Best-Practice Differentiated Power Cord Coloration Implementation..... 149

Figure 33: Equipment-Specific Cable Management Requirements..... 150

Figure 34: Acceptable Cable Management Results..... 151

Figure 35. Unacceptable Cable Management Results 152

Figure 36: Cable Labels in Bundles 154



C.2 Tables

<i>Table 1: Revision History</i>	1
<i>Table 2: Data Center Classification Standards</i>	13
<i>Table 3: Data Center Planned Redundancy Levels</i>	17
<i>Table 4: Core Data Center and Campus Support Center Planned Redundancy Levels</i>	19
<i>Table 5: Mission Support Center Planned Redundancy Levels</i>	21
<i>Table 6: Network Support Center, Telecommunications Room, Entrance Room, and Antenna Entrance Room Planned Redundancy Levels</i>	23
<i>Table 7: Building Specifications</i>	26
<i>Table 8: Data Center Floor Layout Standards</i>	28
<i>Table 9: Small Clinical Environment Racks and Telecommunications Room Sizing per Serving Area</i>	31
<i>Table 10: Non-medical Space Racks and Telecommunications Room Sizing per Active Work Area Outlet Density in Supported Serving Zone</i>	32
<i>Table 11: Data Center Uninterruptible Power Supply Specifications</i>	42
<i>Table 12: Branch Power Circuit to Rack/Cabinet Standards (Underfloor/Whip Distribution)</i>	47
<i>Table 13: Branch Power Circuit to Rack/Cabinet Standards (Busway Distribution)</i>	48
<i>Table 14: Zone Power Distribution Unit Standards</i>	49
<i>Table 15: Rack Mounted Uninterruptible Power Supply Standards</i>	51
<i>Table 16: Vertical Rack Power Distribution Unit Standards</i>	52
<i>Table 17: IT Equipment Power Cord Standards</i>	54
<i>Table 18: Busbar Standards</i>	61
<i>Table 19: Building Earth Ground System Standards</i>	62
<i>Table 20: Lightning Protection System</i>	62
<i>Table 21: Metered Energy Consumption Data</i>	64
<i>Table 22: Energy Consumption Performance Metrics</i>	68
<i>Table 23: Data Center Facility Environment Conditioning Standards</i>	72
<i>Table 24: Facility Environmental Requirements (CDC Amendments and Exceptions)</i>	74
<i>Table 25: Facility Environmental Requirements (MSC Amendments and Exceptions)</i>	74
<i>Table 26: Facility Environmental Requirements (NSC Amendments and Exceptions)</i>	75
<i>Table 27: Environmental Control Equipment</i>	76
<i>Table 28: Monitored Conditions (MSC, CSC, and CDC)</i>	87
<i>Table 29: Unshielded Twisted Pair Standards</i>	94
<i>Table 30: Unshielded Twisted Pair Patch Panel Standards</i>	96



Table 31: Unshielded Twisted Pair Patch Cord Standards 97

Table 32: Fiber Optic Cable Standards..... 99

Table 33: Fiber Distribution Cassettes 103

Table 34: Fiber Patch Cord Standards..... 104

Table 35: Fiber Distribution Panel/Cabinet Standards..... 105

Table 36: Cable Support Infrastructure Standards..... 106

Table 37: Cable Distribution Standards..... 107

Table 38: Server Cabinet Standards..... 112

Table 39: Network Equipment Racks..... 115

Table 40: Network Equipment Cabinet Standards 117

Table 41: Data center Position Identification Conventions..... 122

*Table 42: Standard FACILITYTYPE Naming Conventions – Campus Support Centers (CSC)** 126

Table 43: Standard FACILITYTYPE Naming Conventions - Mission Support Centers (MSC)..... 126

Table 44: Standard FACILITYTYPE Naming Conventions - Network Support Centers (NSC)..... 127

Table 45: Information Technology Systems Equipment and Component Labeling Conventions..... 130

Table 46: Support Infrastructure Identification Conventions 132

Table 47: Transport Media and Interface Identification Conventions..... 136

Table 48: Power Distribution Identification Conventions 141

Table 49: Color Identification Conventions..... 148

Table 50: Acronyms..... 181

Table 51: Contributors..... 189



C.3 Definitions

Access Provider: The operator of any facility that is used to convey telecommunications signals to and from a customer premises.

Administration: The method for labeling, identification, documentation, and usage needed for installation, moves, additions and changes of the telecommunications infrastructure.

Alarming: Communicating when an absolute limit has been exceeded.

Alerting: Communicating when a condition threshold has been reached or exceeded.

American Society of Heating and Air-Conditioning Engineers (ASHRAE) Recommended Monitoring Locations (Modified):

- Front Top (FT): Centered horizontally, inside the front door, no more than 1 ft from the top of the cabinet
- Front Middle (FM): Centered horizontally, inside the front door, 4 ft +/- 6 in. from the finished floor surface
- Front Bottom (FB): Centered horizontally, inside the front door, no more than 1 ft from the finished floor surface
- Rear Top (RT): Centered horizontally, inside the rear door, no more than 1 ft from the top of the cabinet
- Rear Middle (RM): Centered horizontally, inside the rear door, 4 ft +/- 6 in. from the finished floor surface (not required by VA but recommended)
- Rear Bottom (RB): Centered horizontally, inside the rear door, no more than 1 ft from the finished floor surface (not required by VA but recommended)

Antenna Entrance Room: A room to accommodate all provided and planned Radio Frequency (RF) based systems and headend cabinets and equipment.

Backbone:

- A facility (e.g., pathway, cable, conductors, optical fibers) between any of the following spaces: telecommunications rooms (TRs), Telecommunications Enclosures (TE), common TRs, floor-serving terminals, entrance facilities, equipment rooms, and common equipment rooms.
- In a data center, a facility (e.g., pathway, cable, conductors, optical fibers) between any of the following spaces: entrance rooms or spaces, antenna entrance rooms, Main Distribution Areas (MDA), Horizontal Distribution Areas (HDA), Zone Distribution Areas (ZDA), and TRs.

Backbone Bonding Conductor: A telecommunication bonding connection which interconnects telecommunications bonding.

Busway: A pre-fabricated electrical distribution system used as an effective alternative to cable and conduit consisting of busbars in a protective enclosure, including straight lengths, fittings,



devices, and accessories. Busway transports electricity and connects to electrical gear such as switchgear, panelboards and transformers.

Bonding: The permanent joining of metallic parts to form an electrically conducive path that ensures electrical continuity and the capacity to conduct safely any current likely to be imposed.

Cabinet: A container that may enclose connection devices, terminations, apparatus, wiring, and equipment.

Channel: All telecommunications cable elements, permanent cable (link) and patching elements, that connect two pieces of IT equipment.

Channel Rack: A network four-post rack with sides having a cable management pattern of staggered shapes (circles, hexagons, etc.) to allow for connection points for cable management accessories used for housing networking equipment.

Compression Connection: A means of permanently bonding a conductor to a connector by permanently deforming the connector using a compression tool.

Computer Room: An architectural space whose primary function is to accommodate data processing equipment.

Concurrently Maintainable: The ability to have planned maintenance performed at any time on any path, equipment, or component of the system without interrupting the operation of the system.

Cross-connect: A facility enabling the termination of cable elements and their interconnection or cross connection.

Conduit: (1) A raceway of circular cross-section. (2) A structure containing one or more ducts.

Data Center: A building or portion of a building whose primary function is to house a computer room and its support areas.

Demarcation Point: A physical location, typically in the entrance room, where the operational control or ownership of the incoming service provider media changes from Service Provider to customer.

Dew Point: The temperature to which air must be cooled (assuming constant air pressure and moisture content) to reach a relative humidity of 100 % (i.e., saturation).

Electromagnetic Interference (EMI): Radiated or conducted electromagnetic energy (noise) of any frequency that has an undesirable effect on electronic equipment or signal transmissions.



Entrance Room: A space in which the joining of inter or intra building telecommunications cabling takes place.

Equipment Distributor (ED): Reservation of the top 5 Rack Units (RU) of space in a server cabinet for copper and fiber patch panel equipment.

Exothermic Weld: A method of permanently bonding two metals together by a controlled heat reaction resulting in a molecular bond.

Facility Total Electrical Consumption (FEC): Total of all energy used from all sourced by the building housing the data center. This metric requires totaling the amount of electrical energy going into the building through the building's main step-down transformer(s) and the amount of electrical energy generated through running any facility or data center generator equipment.

Ground: A conducting connection, whether intentional or accidental, between an electrical circuit (e.g., telecommunications) or equipment and the earth, or to some conducting body that serves in place of earth.

Grounding: The act of creating a ground.

Grounding Electrode: A conductor, usually a rod, pipe, or plate (or group of conductors) in direct contact with the earth for the purpose of providing a low-impedance connection to the earth.

Grounding Electrode System: One or more grounding electrodes that are connected.

Horizontal Cabling: (1) The cabling (media) between and including the telecommunications outlet and connector and the horizontal cross connect, usually in a telecommunications room. (2) Within a data center, the media between the equipment distributor and the horizontal distributor.

Horizontal Distribution Area (HDA): Distribution used to serve equipment areas when the horizontal cabling is not located in the main distribution area. When used, the horizontal distribution area may include the horizontal cabling, which is the distribution point for cabling to the equipment distribution areas.

Information Transport Systems (ITS): The physical connectivity elements required to deliver a high-performance, reliable network system infrastructure for all requirements including data, voice, and video.

Infrastructure (telecommunications): A collection of those telecommunications components, excluding equipment, that together provide the basic support for the distribution of information within a building or campus.

Link: A single permanently-installed telecommunications cable element. See also permanent link.



Listed: Equipment included in a list published by an organization, acceptable to the authority having jurisdiction, that maintains periodic inspection of production of listed equipment, and whose listing states either that the equipment or material meets appropriate standards or has been tested and found suitable for use in a specified manner.

Main Distribution Area (MDA): The central point of distribution for the data center structured cabling system which includes the main cross-connect and may include horizontal cross-connect when equipment areas are served directly from the main distribution area.

Mechanical Connection: A reversible means of connecting a conductor to a connector using a set screw or other bolt and nut device.

Mechanical Room: An enclosed space serving the needs of mechanical building systems.

Media: Wire, cable, or conductors used for telecommunications (transmission of signal).

Mesh Bonding Network: The set of metallic components that are interconnected to form the principle means for effectively bonding equipment inside a building to the grounding electrode system.

Metering: Measurement of a condition or set of conditions over a period of time. Metering is primarily a data collection function, intended to support analysis of operational characteristics of a data center.

Monitoring: Continual real-time observation of a condition or set of conditions affecting a data center.

Multimode Optical Fiber: An optical fiber that carries many paths of light.

Patch Cord: A cord used to establish connections on a patch panel.

Patch Panel: A connecting hardware system that facilitates cable termination and cabling administration using patch cords.

Pathway: A facility for the placement of telecommunications cable.

Permanent Link: The permanent, or fixed part of the network comprised of components that will permanently stay in place, such as patch panels, horizontal or backbone cable, and an outlet.

Plenum: A compartment or chamber to which one or more air ducts are connected and forms part of the air distribution system.

Pod: A modular subset of the data center.



Power Usage Effectiveness (PUE): A dimensionless metric which describes how efficiently a data center is designed and operated to conserve power. PUE is defined as the ratio: Total Data Center Energy Consumption (TEC)/Total IT Equipment Energy Consumption (TITEC) or TEC/TITEC.

Primary Bonding Busbar (PBB): The dedicated extension of the building grounding electrode system for the telecommunications infrastructure. The PBB also serves as the central attachment point for the TBB(s) and equipment.

Rack: Supporting frame equipped with side mounting rails to which equipment and hardware are mounted.

Rack Bonding Busbar (RBB): A busbar within a cabinet, frame, or rack.

Rack Bonding Conductor (RBC): The bonding conductor from the rack or rack bonding busbar to the telecommunications equipment bonding conductor.

Rack Unit (RU): Vertical mounting space of 1.75 in. for cabinets or racks compliant with IEC 60297 or EIA/ECA-310-E.

Radio Frequency Interference (RFI): Radiated or conducted electromagnetic energy (noise) of a specific frequency that has an undesirable effect on electronic equipment or signal transmissions.

Raised Floor aka Access Floor: A platform with removable panels where equipment is installed, with the intervening space between it and the main building floor used to house the interconnecting cables and at times is used as a means for supplying conditioned air to the IT equipment and the room.

Secondary Bonding Busbar (SBB): A common point of connection for telecommunications system and equipment bonding to ground located in the distributor room.

Service Provider: The operator of any service that furnishes telecommunications content(transmissions) delivered over access provider facilities.

Single-Mode Optical Fiber: An optical fiber that carries only one path of light.

Site Infrastructure Energy Efficiency Rating (SIEER): A dimensionless metric which describes how efficiently a data center is designed and operated to conserve power. SIEER is defined as the ratio: Total Data Center Energy Consumption (TEC)/Total Uninterruptible Power Supply (UPS) Load Energy Consumption (TUPEC) or TEC/TUPSC.

Telecommunications: Any transmission, emission, and receptions of information by cable, radio, optical, or other electromagnetic systems including signaling commonly referred to as "data."



Telecommunications Room (TR): A telecommunications space that differs from equipment rooms, entrance rooms, and antenna entrance rooms in that this space is a floor-serving space that provides a connection point between backbone and horizontal cabling. The terms “closet,” “telecom closet,” “phone closet,” “Intermediate Distribution Frame (IDF),” etc. are no longer used. Design documents are to use the abbreviation “TR.”

Telecommunications Space: An area used for housing the installation and termination of telecommunications equipment and cable. Telecommunications spaces include telecommunications rooms, entrance rooms, antenna entrance rooms, data centers, computer rooms, horizontal pathways, vertical pathways, etc. The term “telecommunications spaces” is used interoperably with the term “IT support space.”

Total Data Center Energy Consumption (TEC): Summation of all energy used from all sources required to power all infrastructure and equipment within the confines of a data center.

Total Data Center Physical Infrastructure Energy Consumption: Summation of all energy used by facilities physical infrastructure equipment that supports the computer space. This is the total amount of electricity necessary to run all mechanical and electrical equipment providing support to the computer space but does not include the IT Equipment Load Electrical Consumption.

Total IT Equipment Energy Consumption (TITEC): Summation of all energy directly consumed by IT equipment in the data center. IT equipment includes, but is not limited to, computers, storage systems, and networking gear.

Total Renewable Energy Usage by Data Center (RENEW): Summation of all electricity consumed by the facility housing the VA computer facility generated from renewable resources (solar, wind, hydro, wave, and similar) locally or through the supplying utility. Hydrocarbon and nuclear utility sources are not considered renewable for the purposes of this value.

Total UPS Load Energy Consumption (TUPEC): Summation of all energy used on the load (not source) side(s) of all UPS system(s) supporting the critical load in the computer space.

Track Busway: A continuous rail design where tap-off boxes can be installed or removed nearly anywhere along the busway system. The tap-off boxes come equipped with cord whips and fixed receptacles allowing for power distribution to equipment below the busway.

Uninterruptible Power Supply (UPS): A buffer between utility power or other power source and a load that requires continuous precise power.

Work Area: A building space where the occupants interact with telecommunications terminal equipment.

Work Area Outlet (WAO): A fixed connector in an equipment outlet assembly consisting of faceplate, body, housing, and one or more telecommunications cabling interface in the building



space where the occupants interact with telecommunications terminal equipment. The term “jack” is no longer used.

Zone Distribution Area (ZDA): A space in a data center where an equipment outlet or a consolidation point is located.

C.4 References

References are effective from their date of publication unless otherwise stated and are inclusive of supplements or addenda published by the standards body, amendments adopted by Authority Having Jurisdiction (AHJ), and superseding standards. The list is not comprehensive; compliance with all applicable standards is required. References consist primarily of nationally recognized “model” building codes, and technical standards developed or adopted by voluntary consensus standards bodies, use of which is required by P.L. 100-678, P.L. 104-113, and OMB Circular A119.

ANSI/ASHRAE Addendum 15c, Safety Code for Mechanical Refrigeration

ANSI/ASHRAE Addendum 15d, Safety Code for Mechanical Refrigeration

ANSI/ASHRAE 62.1, Ventilation for Acceptable Indoor Air Quality

ANSI/ASHRAE 135, BACnet - A Data Communication Protocol for Building Automation and Control Networks

ANSI/ASHRAE 135 ERTA, BACnet - A Data Communication Protocol for Building Automation and Control Network

ANSI/ASHRAE 135 INT 1, BACnet - A Data Communication Protocol for Building Automation and Control Network

ANSI/ASHRAE 135 INT 2, BACnet - A Data Communication Protocol for Building Automation and Control Network

ANSI/ASHRAE Standard 90.4, Energy Standard for Data Centers

ANSI/ASHRAE Standard 188, Legionellosis: Risk Management for Building Water Systems

ANSI/BICSI 002-2019 Data Center Design and Implementation Best Practices

ANSI/BICSI 004-2018, Information Communication Technology Systems Design and Implementation Best Practices for Healthcare Institutions and Facilities

ANSI/BICSI N1-2019, Installation Practices for Telecommunications and ICT Cabling and Related Cabling Infrastructure

ANSI/NECA/BICSI 568-2006, Standard for Installing Commercial Building Telecommunications Cabling (superseded by ANSI/BICSI N1-2019)

ANSI/NECA/BICSI 607-2011, Standard for Telecommunications Bonding and Grounding Planning and Installation Methods for Commercial Buildings



ANSI/TIA-232-F, Interface Between Data Terminal Equipment and Data Circuit-Terminating Equipment Employing Serial Binary Data Interchange

ANSI/TIA-455-C, General requirements for standard test procedures for optical fibers, cables, transducers, sensors, connecting and terminating devices, and other fiber optic components

ANSI/TIA-455-1-B, Cable Flexing for Fiber Optic Interconnecting Devices

ANSI/TIA-455-2C, Impact Test Measurements for Fiber Optic Devices

ANSI/TIA-455-4C, FOTP-4 Fiber Optic Component Temperature Life Test

ANSI/TIA-455-5C, FOTP-5 Humidity Test Procedure for Fiber Optic Components

ANSI/TIA-455-6-B, FOTP 6 Cable Retention Test Procedure for Fiber Optic Cable Interconnecting Devices

ANSI/TIA-455-8, FOTP-8 Measurement of Splice or Connector Loss and Reflectance Using an OTDR

ANSI/TIA-455-13-A, FOTP-13 Visual and Mechanical Inspection of Fiber Optic Components, Devices, and Assemblies

ANSI/TIA-455-21-A, FOTP-21 Mating Durability of Fiber Optic Interconnecting Devices

ANSI/TIA-455-34A, FOTP-34 Interconnection Device Insertion Loss Test

ANSI/TIA-455-36-A, FOTP-36 Twist Test for Fiber Optic Connecting Devices

ANSI/TIA 455 78B, FOTP 78 IEC 60793 1 40 Optical Fibres - Part 1 40: Measurement Methods and Test Procedures Attenuation

ANSI/TIA-455-107-A, FOTP-107 Determination of Component Reflectance or Link/System Return Loss Using a Loss Test Set

ANSI/TIA-455-171A, FOTP-171 Attenuation by Substitution Measurement for Short-Length Multimode Graded-Index and Single-Mode Optical Fiber Cable Assemblies

ANSI/TIA-455-185, FOTP-185 Strength of Coupling Mechanism for Fiber Optic Interconnecting Devices

ANSI/TIA-455-188, FOTP-188 Low Temperature Testing of Fiber Optic Components

ANSI/TIA-470.000-E, Telecommunications Telephone Terminal Equipment Overview of Performance Standards for Analog Telephones



ANSI/TIA-470.110-D, Telecommunications Telephone Terminal Equipment - Transmission Requirements for Analog Telephones with Handsets

ANSI/TIA-485-A, Electrical Characteristics of Generators and Receivers for Use in Balanced Digital Multipoint Systems

ANSI/TIA-492AAAA-B, Detail Specification for 62.5- μm Core Diameter/125- μm Cladding Diameter Class Ia Graded-Index Multimode Optical Fibers

ANSI/TIA-492AAAB-A, Detail Specification for 50- μm Core Diameter/125- μm Cladding Diameter Class Ia Graded-Index Multimode Optical Fibers

ANSI/TIA-492AAAC-B, Detail Specification for 850-nm Laser- Optimized, 50- μm Core Diameter/125- μm Cladding Diameter Class Ia Graded-Index Multimode Optical Fibers

ANSI/TIA-492CAAA, Detail Specification for Class IVa Dispersion-Unshifted Single-Mode Optical Fibers

ANSI/TIA-492CAAB, Detail Specification for Class IVa Dispersion-Unshifted Single-Mode Optical Fibers with Low Water Peak

ANSI/TIA-526-7-A, Measurement of Optical Power Loss of Installed Single-Mode Fiber Cable Plant, Adoption of IEC 61280-4-2 edition 2: Fibre-Optic Communications Subsystem Test Procedures; Part 4-2: Installed Cable Plant Single-Mode Attenuation and Optical Return Loss Measurement

ANSI/TIA-526-14-C, Optical Power Loss Measurement of Installed Multimode Fiber Cable Plant; Modification of IEC 61280-4-1 edition 3.1, Fiber-Optic Communications Subsystem Test Procedures- Part 4-1: Installed Cable Plant-Multimode Attenuation Measurement

ANSI/TIA-561, Simple 8-Position Non-Synchronous Interface Between Data Terminal Equipment and Data Circuit-Terminating Equipment Employing Serial Binary Data Interchange

ANSI/TIA-568.0-E, Generic Telecommunications Cabling for Customer Premises

ANSI/TIA-568.1-E, Commercial Building Telecommunications Infrastructure Standard

ANSI/TIA-568.2-D, Balanced Twisted-Pair Telecommunications Cabling and Components Standard

ANSI/TIA-568.2-D-2, Balanced Twisted-Pair Telecommunications Cabling Standard Addendum 2: Power Delivery Over Balanced Twisted- Pair Cabling

ANSI/TIA-568.3-D, Optical Fiber Cabling and Components Standard

ANSI/TIA-568.4-D, Broadband Coaxial Cabling and Components Standard



ANSI/TIA-568.5-2022, Balanced Single Twisted-pair Telecommunications Cabling and Components Standard

ANSI/TIA-569-D, Telecommunications Pathways and Spaces

ANSI/TIA-569-D-1, Telecommunications Pathways and Spaces: Addendum 1- Revised Temperature and Humidity Requirements for Telecommunications Spaces - Addendum to TIA-569-D

ANSI/TIA-598-D, Optical Fiber Cable Color Coding

ANSI/TIA-604-3-B, FOCIS 3 Fiber Optic Connector Intermateability Standard- Type SC and SC-APC

ANSI/TIA-606-C, Administration Standard for Telecommunications Infrastructure

ANSI/TIA-607-D, Generic Telecommunications Bonding and Grounding (Earthing) for Customer Premises

ANSI/TIA-607-C-1, Generic Telecommunications Bonding and Grounding (Earthing) for Customer Premises - Addendum to ANSI/TIA-607-C

ANSI/TIA-758-B, Customer-Owned Outside Plant Telecommunications Infrastructure Standard

ANSI/TIA-810-B, Telecommunications Telephone Terminal Equipment Transmission Requirements for Narrowband Digital Telephones

ANSI/TIA-862-B, Structured Cabling Infrastructure Standard for Intelligent Building Systems

ANSI/TIA-942-B, Telecommunications Infrastructure Standard for Data Centers

ANSI/TIA-968-B, Telecommunications Telephone Terminal Equipment Technical Requirements for Connection of Terminal Equipment to the Telephone Network

ANSI/TIA-968-B-1, Telecommunications Telephone Terminal Equipment Technical Requirements for Connection of Terminal Equipment to the Telephone Network-Addendum 1- Addendum to TIA-968-B

ANSI/TIA-968-B-2, Telecommunications Telephone Terminal Equipment Technical Requirements for Connection of Terminal Equipment to the Telephone Network- Addendum 2 - Addendum to TIA-968-B

ANSI/TIA-968-B-3, Telecommunications Telephone Terminal Equipment Technical Requirements for Connection of Terminal Equipment to the Telephone Network - Addendum 3 - Addendum to TIA-968-B

ANSI/TIA-1005-A, Telecommunications Infrastructure Standard for Industrial Premises



ANSI/TIA-1005-A-1, Telecommunications Infrastructure Standard for Industrial Premises - Addendum 1- M12-8 X-Coding Connector (Addendum to TIA-1005-A)

ANSI/TIA-1152-A, Requirements for Field Test Instruments and Measurements for Balanced Twisted-Pair Cabling

ANSI/TIA-1179, Healthcare Facility Telecommunications Infrastructure

ANSI/TIA/EIA-455-1-B, Cable Flexing for Fiber Optic Interconnecting Devices

ANSI/TIA/EIA-455-2C, Impact Test Measurements for Fiber Optic Devices

ANSI/TIA/EIA-455-5C, FOTP-5 Humidity Test Procedure for Fiber Optic Components

ANSI/TIA/EIA-455-8, FOTP-8 Measurement of Splice or Connector Loss and Reflectance Using an OTDR

ANSI/TIA/EIA-455-34A, FOTP-34 Interconnection Device Insertion Loss Test

ANSI/TIA/EIA-455-171A, FOTP-171 Attenuation by Substitution Measurement for Short-Length Multimode Graded-Index and Single-Mode Optical Fiber Cable Assemblies

ANSI/TIA/EIA-455-185, FOTP-185 Strength of Coupling Mechanism for Fiber Optic Interconnecting Devices

ANSI/TIA/EIA-455-188, FOTP-188 Low Temperature Testing of Fiber Optic Components

ANSI/TIA/EIA-492CAAB, Detail Specification for Class IVa Dispersion-Unshifted Single-Mode Optical Fibers with Low Water Peak

ANSI/TIA-568-Set, Commercial Building Telecommunications Cabling Standard

ANSI/TIA TSB-153, Static Discharge Between LAN and Data Terminal Equipment

ANSI/TIA TSB-155-A, Guidelines for the Assessment and Mitigation of Installed Category 6 Cabling to Support 10GBASE-T

ANSI/TIA TSB-184-A, Guidelines for Supporting Power Delivery Over Balanced Twisted-Pair Cabling

ANSI/TIA TSB-184-A-1 (Addendum to TSB-184-A), Guidelines for Supporting Power Delivery Over Balanced Twisted-Pair Cabling-Addendum 1- use of 28 AWG cords

American Society of Heating and Air-Conditioning Engineers (ASHRAE) Standard 52.2, Method of Testing General Ventilation Air-Cleaning Devices Removal by Particle Size (ANSI approved)



ASTM B258, Standard Specification for Standard Nominal Diameters and Cross-Sectional Areas of AWG Sizes of Solid Round Wires Used as Electrical Conductors

ASTM B539, Standard Test Methods for Measuring Resistance of Electrical Connections (Static Contacts)

ASTM D4565, Standard Test Methods for Physical and Environmental Performance Properties of Insulations and Jackets for Telecommunications Wire and Cable

ASTM D4566, Standard Test Methods for Electrical Performance Properties of Insulations and Jackets for Telecommunications Wire and Cable

ATIS 0600311, DC Power Systems Telecommunications Environment Protection

ATIS 0600336, Design Requirements for Universal Cabinets and Framework

BICSI ITSIMM, Information Technology Systems Installation Methods Manual (ITSIMM) - 8th Edition

BICSI OSPDRM, Outside Plant Design Reference Manual (OSPDRM) - 6th Edition

BICSI TDMM, Telecommunications Distribution Methods Manual - 14th Edition; Volumes I & II

CSI MASTERFORMAT™ 2020 EDITION NUMBERS & TITLES Construction Specifications Institute (CSI)

ECIA EIA/ECA-310-E, Cabinets, Racks, Panels, and Associated Equipment

Executive Order No. 13693 “Federal Leadership on Climate Change and Environmental Sustainability” 2015

Executive Order No. 13834 “Efficient Federal Operations” 2018

Federal Information Processing Standard (FIPS) 200, Minimum Security Requirements for Federal Information and Information Systems

IEEE STD 81, Guide for Measuring Earth Resistivity, Ground Impedance, and Earth Surface Potentials of a Grounding System

IEEE STD 446, Emergency and Standby Power Systems for Industrial and Commercial Applications (Orange Book)

MIL-STD-188-124B, Grounding, Shielding, and Bonding

Motorola Standards and Guidelines for Communication Sites, 68P81089E50-C, April 2017

National Energy Policy Act of 2005-SEC. 203. FEDERAL PURCHASE REQUIREMENT



NEMA FG 1, Fiberglass Cable Tray Systems - Revision No.1

NEMA VE 1, METAL CABLE TRAY SYSTEMS

NEMA VE 2, Cable Tray Installation Guidelines - Incorporates Errata 2016

NFPA 13, Standard for the Installation of Sprinkler Systems

NFPA 70, National Electrical Code®

NFPA 70E, Standard for Electrical Safety in the Workplace

NFPA 72, National Fire Alarm and Signaling Code

NFPA 75, Standard for the Fire Protection of Information Technology Equipment

NFPA 99, Healthcare Facilities Code

NFPA 101, Life Safety Code

NFPA 780, Standard for the Installation of Lightning Protection Systems

NFPA 2001, Standard on Clean Agent Fire Extinguishing Systems

PG-18-12 OIT Design Guide, Office of Construction and Facilities Management Design Guide
(Superseded. See Standards Alert 017 R01b)

Physical Security and Resiliency Design Manual

Presidential Memorandum 131205, "Federal Leadership on Energy Management"

UL 444, UL Standard for Safety Communications Cables - 5th Edition

UL 444 BULLETIN, UL Standard for Safety Communications Cables

VA DIRECTIVE 6008, ACQUISITION AND MANAGEMENT OF VA INFORMATION TECHNOLOGY
ASSETS

VA DIRECTIVE 6500, INFORMATION SECURITY PROGRAM

VA Electrical Design Manual

VA Fire Protection Design Manual

VA HVAC Design Manual

VA Lighting Design Manual



VA OIT Design Guide

VA Operations and Maintenance Standard for Telecommunications Spaces (Pending publication)

VA Physical Security and Resiliency Design Manual

VA Sustainable Design Manual

VA Telecommunications and Special Telecommunications Systems Design Manual

VHA Directive 1061, Prevention of Healthcare-Associated Legionella Disease and Scald Injury from Potable Water Distribution Systems



C.5 Acronyms

For other acronyms and initialisms, VA employees and contractors with VA intranet access may refer to the full [VA Acronym List](#). All others may inquire with Enterprise Data Center and Infrastructure Engineering (DCIE) at VAITSEDatacenterEngineering2@va.gov.

Table 50: Acronyms

Acronym	Definition
AC	Alternating Current
ACEG	Alternating Current Equipment Ground
AES	Advanced Encryption Standard
AHJ	Authority Having Jurisdiction
ANSI	American National Standards Institute
APC	Angled Physical Contact
ARU	Air Removal Units
ASD	Aspirated Smoke Detection
ASHRAE	American Society of Heating and Air-Conditioning Engineers
ATS	Automatic Transfer Switch
AWG	American Wire Gauge
BACnet	Building Automation and Control Networking Protocol
BAS	Building Automation System
BCM	Branch Circuit Monitoring
BCP	Branch Circuit Panelboard
BICSI	Building Industry Consulting Service International
BMS	Battery Monitoring System



Acronym	Definition
CAB	Change Advisory Board
CANbus	Controller Area Network Bus
CCTV	Closed Circuit Television
CDC	Core Data Center
CE	Clinical Engineering
CFD	Computational Fluid Dynamics
CFM	Cubic Feet Per Minute
CFM	VA Office of Construction and Facilities Management
CM	Communications
CMMS	Computerized Maintenance Management System
CMOP	Consolidated Mail Outpatient Pharmacy
CMP	Communications Plenum
CMR	Communications Riser
CPAC	Consolidated Patient Account Center
CRAC	Computer Room Air Conditioner
CRAH	Computer Room Air Handler
CSC	Campus Support Center
DAS	Distributed Antenna System
DC	Direct Current
DCIE	Data Center and Infrastructure Engineering
DCIM	Data Center Infrastructure Management



Acronym	Definition
DR	Disaster Recovery
DX	Direct Expansion
EBSR	Enterprise Baseline and Standard Review
EC	Electronically Commutated
ED	Equipment Distributor
EDICT	Enterprise Data Center Infrastructure Collaboration Team
EDM	Electrical Design Manual
EGS	Earth Ground System
EIA	Electronic Industries Alliance
EMCS	Energy Management Control System
EPO	Emergency Power Off
ESD	Electrostatic Discharge
DX	Direct Expansion
FB	Front Bottom
FCU	Fan Coil Units
FEC	Facility Total Electrical Consumption
FM	Front Middle
FMS	Facilities Management Service
FPDM	Fire Protection Design Manual
FSC	Financial Services Center
FSS	Facilities Standards Service



Acronym	Definition
FT	Front Top
GbE	Gigabit Ethernet
Gb/s	Gigabit per second
HAC	Health Administration Center
HCC	Health Care Centers
HEC	Health Eligibility Center
HD	High Density
HDA	Horizontal Distribution Area
HF	High Frequency
HVAC	Heating, Ventilation, and Air Conditioning
IACS	International Annealed Copper Standard
IAW	In Accordance With
ICC	Intermediate Cross Connect
IEC	International Electrotechnical Commission
IEEE	Institute of Electrical and Electronics Engineers
IO	Infrastructure Operations
ISP	Inside Plant
IT	Information Technology
ITOPS	IT Operations and Services
ITS	Information Transport Systems
LAN	Local Area Network



Acronym	Definition
LED	Light Emitting Diode
LFMC	Liquid-tight Flexible Metal Conduit
LP	Limited Power
LPS	Lightning Protection System
MATV	Master Antenna Television
MCC	Main Cross Connect
MM	Multimode
MPDU	Master Power Distribution Unit
MPO	Multi-Fiber Push On
MSC	Mission Support Center
NCA	National Cemetery Administration
NDCOL	National Data Center Operations and Logistics
NEC®	National Electrical Code®
NEMA	National Electrical Manufacturers Association
NFPA	National Fire Protection Association
NSC	Network Support Center
O&M	Operations and Maintenance
OIFO	Office of Information Field Office
OIT	Office of Information and Technology
OM	Optical Multimode
OMB	Office of Management & Budget



Acronym	Definition
OPC	Outpatient Clinic
PA	Public Address
PBB	Primary Bonding Busbar
PDU	Power Distribution Unit
PoE	Power-over-Ethernet
PVC	Polyvinyl Chloride
PS	Power Supply
PUE	Power Usage Effectiveness
R&D	Research & Development
RB	Rear Bottom
RBB	Rack Bonding Busbar
RBC	Rack Bonding Conductor
RCDD	Registered Communications Distribution Designer
RDC	Regional Data Center
RDC	Remote Distribution Cabinet
RED	Radio Entertainment Distribution
RF	Radio Frequency
RH	Relative Humidity
RM	Rear Middle
rPDU	Rack Power Distribution Unit
RPS	Radio Paging System



Acronym	Definition
RT	Rear Top
RT	Refrigeration Ton
RU	Rack Unit
SBB	Secondary Bonding Busbar
SAN	Storage Area Network
SD	Standard Density
SIEER	Site Infrastructure Energy Efficiency Rating
SM	Single-mode
SSL	Secure Sockets Layer
SSTV	Security Surveillance Television
SWDM	Short Wavelength Division Multiplexing
TBB	Telecommunication Bonding Backbone
TEBC	Telecommunications Equipment Bonding Conductor
TEC	Total Data Center Energy Consumption
TIA	Telecommunications Industry Association
TIL	Technical Information Library
TITEC	Total IT Equipment Energy Consumption
TPIEC	Total Data Center Physical Infrastructure Energy Consumption
TR	Telecommunications Room
TUPSC	Total UPS Load Energy Consumption
TVRO	Television Receive Only Master Antenna Satellite Television



Acronym	Definition
UBC	Unit Bonding Conductor
UL	Underwriters Laboratories Inc
UTP	Unshielded Twisted Pair
VA	Department of Veterans Affairs
VAMC	Veterans Affairs Medical Center
VACO	VA Central Office
VBA	Veterans Benefits Administration
VED	Vertical Exhaust Duct
VESDA	Very Early Smoke Detection Apparatus
VHA	Veterans Health Administration
VLA	Vented Lead Acid
VRLA	Valve Regulated Lead Acid
VSAT	Very Small Aperture Terminal
VSD	Variable Speed Drive
VSS	Video Surveillance Systems
WC	Water Column
zPDU	Zone Power Distribution Unit



C.6 Contributors

This Standard is maintained by the Enterprise Data Center Infrastructure Collaboration Team (EDICT).



Contributors to the development of this document are as follows:

Table 51: Contributors

Name	Office	Role
Michael Julian	Office of Information and Technology (OIT), Infrastructure Operations (IO), Application Hosting, Cloud, and Edge Solutions (ACES)(OIT IO ACES, Data Center and Infrastructure Engineering (DCIE)	SME, Team Leader, Telecommunications Distribution Design, Original Standard Author
Kelly Bates	OIT IO ACESDCIE	SME, Electrical and Mechanical Design
Kevin Grzelka	OIT IO ACESDCIE	SME, Telecommunications Space Design, Template Author and Custodian
John Wernau	OIT IO ACESDCIE	SME, Energy Efficiency and Airflow Design, Standard Custodian
Kirk Thibodeaux	OIT IO ACES	Networks SME
Evan Yeoh	OIT IO ACES	Engineering SME
Earl McMannis	OIT IO ACES	Engineering SME
Jeff Lawlor	OIT IO ACES	Engineering SME
Scott Price	OIT IO ACES	Engineering SME
Carl Dahlstedt	OIT IO ACES	Engineering SME
Jim Cullum	Healthcare Environment and Facilities Programs (HEFP) Special Engineering Projects (SEP)(HEFP SEP)	SME
Elizabeth Emmons	HEFP SEP	SME
Michael Neese	HEFP SEP - Electronic Health Record Modernization (EHRM)	SME
Mitch Cobb	HEFP SEP - EHRM	SME

Name	Office	Role
Carlyle Chan	HEFP SEP - EHRM	SME
Stephen Benson	HEFP SEP - EHRM	SME
Gregory Massey	Office of Healthcare Engineering	Electrical SME
Lawrence Manzanera	OIT ITOPS IO National Data Center Operations and Logistics (NDCOL)	SME
Wesley Patton	NDCOL	Mechanical SME
Brian Baker	NDCOL	DCIM SME
Robert Skipper	NDCOL	DCIM SME
Bryan Unger	Office of Construction and Facilities Management (CFM) Facilities Standards Service (FSS)(CFM FSS)	SME, Coordinator – CFM Technical Information Library (TIL)
Dat Tran	CFM	Electrical SME
Hy Dang	CFM	Electrical SME
Asesh Raychaudhuri	CFM	Mechanical SME
Don Walden	CFM	Mechanical SME
Michael Taylor	CFM	Mechanical SME
Jason Lambie	CFM	Real Property Leasing
Nicholas Hall	CFM	Real Property Leasing
Dave Tashakkori	Consulting Support Service (CSS)	Director, CSS
Shawn Lee	CSS	Telecommunications SME
Art Keller	Infrastructure Operations (IO)	IT Project Manager
Glenn Porter	Bob David Rowe (BDR) Solutions, LLC	Program Manager
Tim Draper	BDR	QA Manager
Matthew Shaffer	BDR	Functional Area Expert II
Christopher Martin	BDR	Functional Area Expert II
Aditya Chebolu	BDR	Technical Writing, CommonLook Office
Myra Coffield	Section 508 Office	Technical Writing, CommonLook Office

